

# PD5000 MORTISE LOCK

for Sliding or Pocket Doors



## SPECIFICATIONS

<b>Door Thickness</b>	1-3/4" (45mm) Standard Thick Door Kits available
<b>Thin Pocket Door Options</b>	1-3/8" (35mm) use FH17, FH27SL, FH22CF, or FH23CF flush pull options
<b>Handing</b>	Non-Handed
<b>Thumbturn Spindle</b>	5mm x 5mm square
<b>Deadbolt</b>	1" (25.4mm) for 2-3/4" or 2-1/2" backset 3/4" (19mm) for 2" backset
<b>Cylinder</b>	Schlage C keyway 5 pin mortise cylinder with 2 keys (KD) Keying Services available; order separately
<b>Lockcase</b>	Heavy Gauge Steel
<b>Deadbolt &amp; Edge Pull</b>	Brass and Stainless Steel
<b>Faceplate &amp; Strike</b>	Stainless Steel

## FEATURES

- Provides new possibilities for sliding door locks, with a variety of residential and commercial applications
- Constructed of heavy gauge steel and coupled with beautiful designer flush and surface pull options
- Array of beautiful, long-lasting finishes including ceramic coating options for aesthetic perfection

## STANDARD FINISHES

- Surface Pull standard finishes, please see pages 53-55
- Flush Pull standard finishes, please see page 40

*For additional finish options not listed, contact Sales Department for MOQ and lead times*

# PD5000 COMPONENTS AND DIMENSIONS

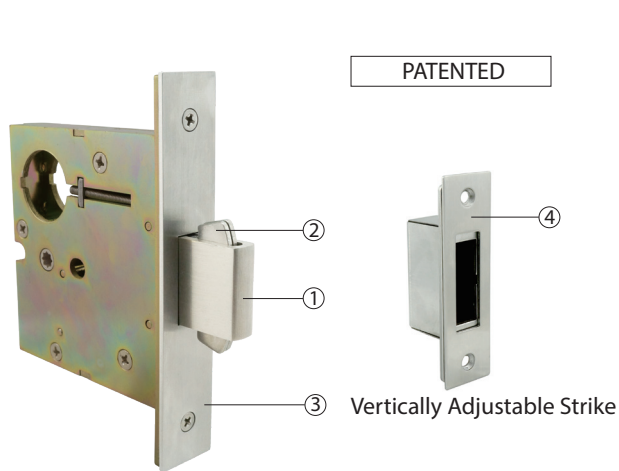

- 1) Brass deadbolt with 1" throw for 2-3/4" or 2-1/2" backset and 3/4" throw for 2" backset
- 2) Self-retracting hook with non-marring latch bolt
- 3) Stainless steel faceplate, 2mm thick
- 4) Vertically adjustable strike

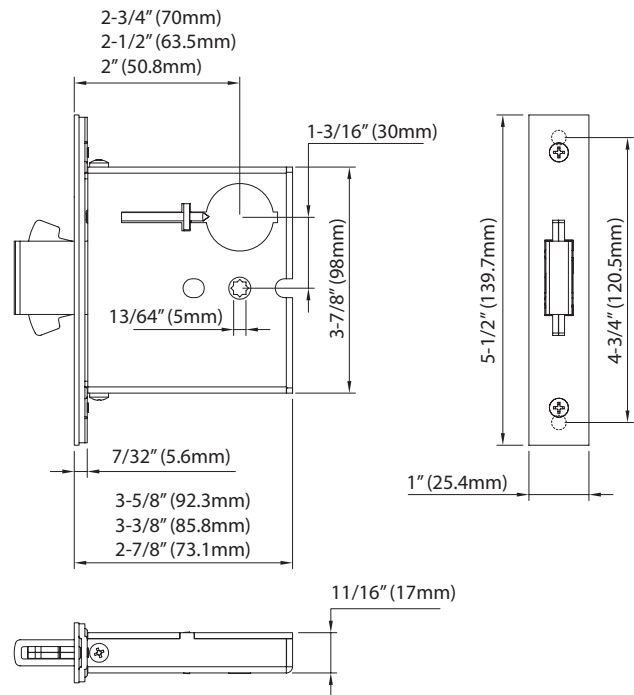

## LOCK OPTIONS



- |  |   |  |
|--|---|--|
| <p><b>PD50</b> (2-1/2" / 2-3/4" Backset)<br/> <b>PD50B</b> (2" Backset)</p> <ul style="list-style-type: none"> <li>• Lock Case with Edge Pull</li> </ul> | <p><b>PD52</b> (2-1/2" / 2-3/4" Backset)<br/> <b>PD52B</b> (2" Backset)</p> <ul style="list-style-type: none"> <li>• Lockcase with built-in Dust Proof Strike for inactive pair of sliding doors</li> <li>• No Edge Pull</li> </ul> | <p><b>PD53</b> (2-3/4" Backset)<br/> <b>PD53A</b> (2-1/2" Backset)<br/> <b>PD53B</b> (2" Backset)</p> <ul style="list-style-type: none"> <li>• Lockcase with Deadbolt</li> <li>• No Edge Pull</li> </ul> |
|--|---|--|

# PD5000 FUNCTIONS

## Sliding Door

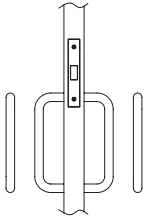

**PD5215**  
**Passage with Lockcase as Dust Proof Strike**  
 • Lockcase used as dust proof strike on pair of sliding doors, inactive side

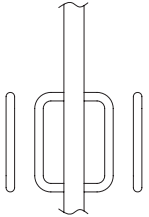

**BTB**  
**Dummy/Passage without Lock Case**

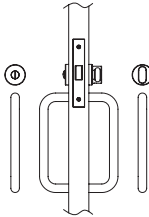

**PD5340**  
**Privacy with Emergency Release**  
 • Deadbolt operated by inside thumbturn or outside emergency release coin turn

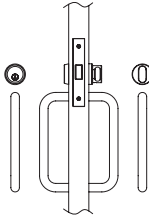

**PD5350**  
**Entry with Single Cylinder**  
 • Key outside or Thumbturn inside retracts deadbolt

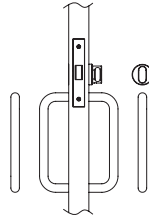

**PD5360**  
**Patio**  
 • Deadbolt operated by Thumbturn from inside only

## Pocket Door

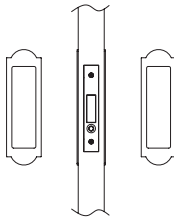

**PD5010**  
**Passage with Lockcase**  
 • Used as flush pull or matching trim on pairs of pocket doors  
 • Edge finger pull operated by push button

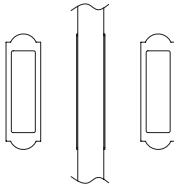

**DP**  
**Dummy/Passage without Lock Case**  
 • No Edge pull