

TL7

Magnetic Tubular Latch For Swing Doors



HIGHLIGHTS

- Magnetic latching eliminates the need for lip strikes and lip cut-outs on door frame
- Both latch bolt and strike design incorporate neodymium magnets, the strongest in commercial use
- 28-degree retraction supports ergonomic ease of use
- Applicable with all INOX decorative levers, knob, and escutcheon designs with no special modification

SPECIFICATIONS

Edge Bore	1" Edge Bore Latch face 2-1/4" x 1" square
Door Thickness	1-3/8"(35mm) to 1-3/4"(44mm) Thick door kits available
Backset	2-3/8" (60mm) 2-3/4" (70mm)
Lever Spindle	8 x 8mm square
Lever Action	28 degree
Handing	Latch is field reversible Specify for Half Passage

APPLICATION

TL7 Magnetic Tubular latches are suitable for a wide range of applications, including but not limited to: Hospitality and high-end Residential.

DOOR PREPARATION

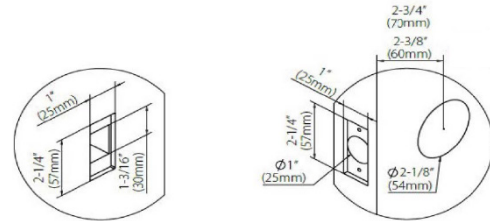

Strike Prep

Latch Prep

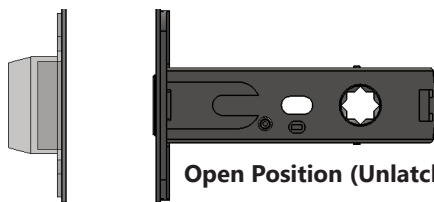

Open Position (Unlatched):

Latch bolt is completely retracted when the door is open for improved path of access.

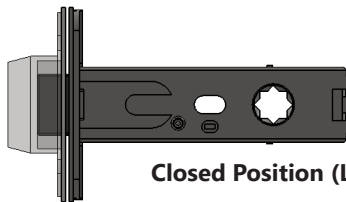

Closed Position (Latched):

When door is closed, rather than a lip strike forcing the bolt into the strike, a powerful rare earth magnet instantly and quietly snaps the bolt in place to latch the door.

HOW TO ORDER

Specify the Rose, Lever Design, Function, Backset, Finish and Handing using the product identification below:

Standard Product Identifications

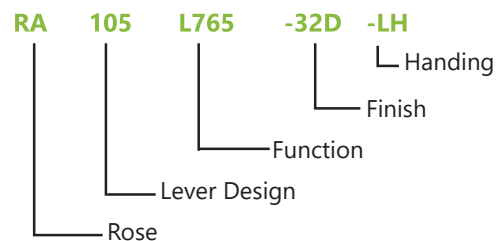

FUNCTION

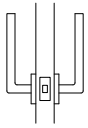

Passage

- Both levers are always unlocked

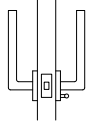

Privacy

- Push the privacy pin from inside to lock door
- Unlock by turning inside lever or using emergency release pinhole located on outside rose or plate cover

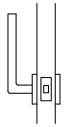

Half Passage

- Outside lever always unlocked; inside, dummy rose only
- Door cannot be opened from inside

DIMENSIONS

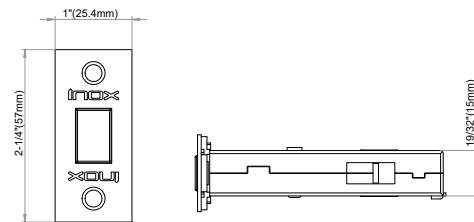
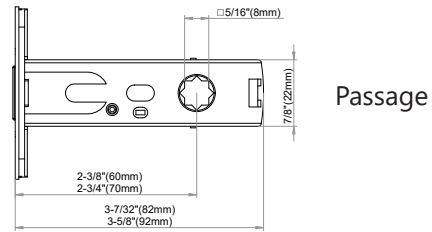
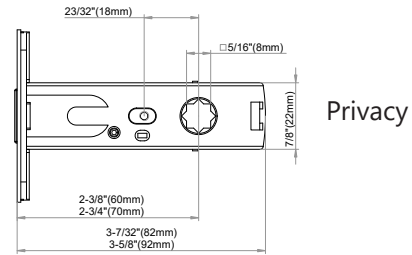

FUNCTION TABLE

	Passage	Privacy	Half Passage
2-3/4" backset code	L771	L772	L775
2-3/8" backset code	L761	L762	L765
Latch	×	×	×
Levers	×	×	×

TL7 MAGNETIC LATCH

COMPONENTS

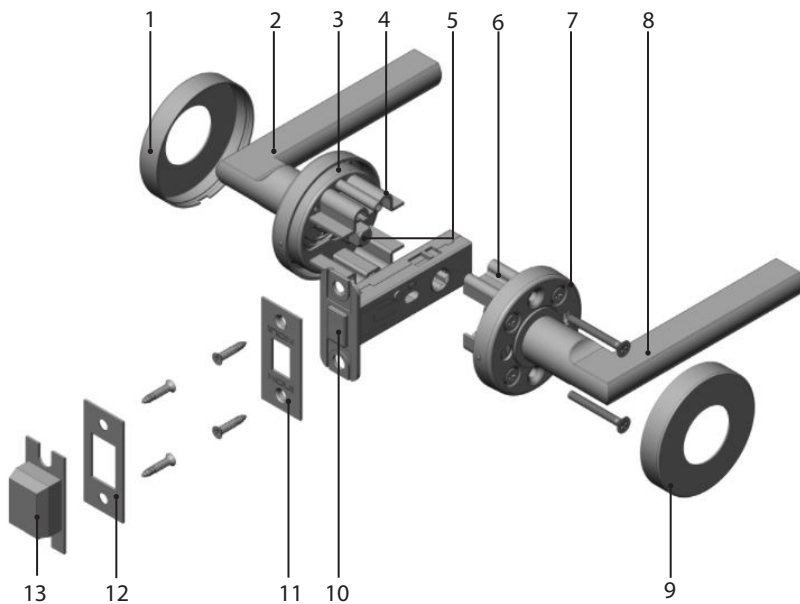

1. Outside Rose
2. Outside Lever
3. Sub-rose
4. Stabilizing Bracket
5. Spindle
6. Interior Bracket
7. Sub-rose
8. Inside Lever
9. Inside Rose
10. TL7 Magnetic Latch
11. Latch Faceplate
12. Strike Faceplate
13. Magnetic Dust Box

FINISH

Standard:

- 32 Bright Stainless Steel
- 32D Satin Stainless Steel
- 19G Graphite Black
- 10B Oil Rubbed Bronze
- PVD4 Satin Brass PVD

Special Order:

- CeraMax Ceramic Coating
 - C19G Ceramic Graphite Black
 - C19 Ceramic Flat Black
 - CGY Ceramic Stormy Grey
 - CDB Ceramic Dark Bronze

MATERIAL

Stainless Steel Face and Strike

ROSE AND ESCUTCHEONS



RA Rose



GT Rose



SE Rose



GS Rose



SH Plate

LEVER DESIGN



101 Cologne
(32, 32D)



103 Oslo
(32, 32D)



104 Brussels
(32, 32D)



105 Frankfurt
(32, 32D, 10B, 19G)



106 Copenhagen
(32, 32D, 10B)



107 Stockholm
(32, 32D)



108 Vienna
(SP, PVD4)



210 Air-stream
(32, 32D, 10B)



211 Breeze
(32, 32D, 10B)



213 Cabernet
(32, 32D)



214 Champagne
(32, 32D, 10B)



217 Horizon
(32, 32D)



221 Aurora
(32, 32D, 10B, 19G)



223 Phoenix
(32, 32D)



225 Waterfall
(32, 32D)



226 Summer
(32, 32D)



227 Stratus
(32, 32D)



243 Sunrise
(32, 32D, 10B, 19G, PVD4)



251 Sequoia
(32, 32D, SP)



311 Crest
(32, 32D, 10B)



318 Café
(32, 32D, 19G)



344 Ecco
(32, 32D)



345 Tokyo
(32, 32D, 19G)



351 Toronto
(32, 32D)



379 Arctic
(32, 32D)



380 Polaris
(32, 32D, 10B)

Lever Designs with "Return To Door" (RTD)*

*Compliant with fire code



102 Munich
(32, 32D)



109 Stuttgart
(32, 32D)



244 Twilight
(32, 32D)



346 Osaka
(32, 32D)