

TRIM OPTIONS FOR RIM, SVR, LBR

Compatible with ED93/ED70 Exit Devices

CYLINDRICAL TRIM

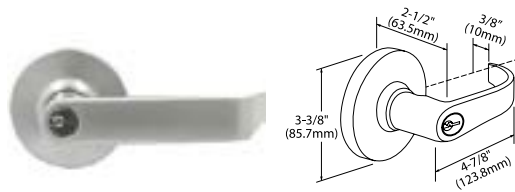

Projection 2-1/2"

Cylinder Size In-lever for Entry & Storeroom function

Images	Description	Part Number	Standard Finish
	Entry Function (ANSI 08)	EDCR07EN	26D Satin Chrome
	Night Latch Function (ANSI 09)	EDCR07NL	26D Satin Chrome
	Passage Function (ANSI 14)	EDCR07BE	26D Satin Chrome
	Dummy Function (ANSI 02)	EDCR07DM	26D Satin Chrome

For additional finish options not listed, contact Sales Department for MOQ and lead times

ESCUTCHEON TRIM

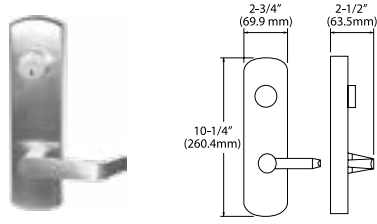

Escutcheon Size 2-3/4" x 10-1/4" (70mm x 260mm)

Cylinder Size 1-1/8" Mortise Cylinder Entry & Storeroom function

Images	Description	Part Number	Standard Finish
	Entry Function Mortise with Cylinder (ANSI 08)	EDES07 EN	32D Satin Stainless Steel 19G Graphite Black 26D Satin Chrome
	Night Latch / Storeroom Function Mortise with Cylinder (ANSI 09)	EDES07 NL* <i>Electrified trim function (EL/EU) available</i>	32D Satin Stainless Steel 19G Graphite Black 26D Satin Chrome
	Passage Function (ANSI 14)	EDES07 BE	32D Satin Stainless Steel 19G Graphite Black 26D Satin Chrome
	Dummy Function (ANSI 02)	EDES07 DM	32D Satin Stainless Steel 19G Graphite Black 26D Satin Chrome

For additional finish options not listed, contact Sales Department for MOQ and lead times

TRIM OPTIONS FOR RIM, SVR, LBR

Compatible with ED93/ED70 Exit Devices

XSF TRIM WITH DESIGN LEVER OPTIONS

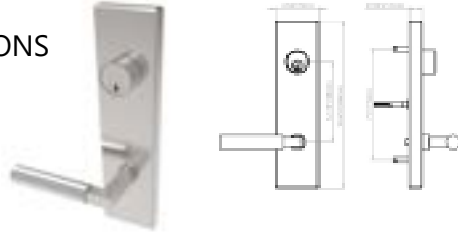

Escutcheon Size

2-3/4" x 10-9/16"
(70mm x 268mm)

Cylinder Size

1-1/8" Mortise Cylinder
Entry & Storeroom function



201 COLOGNE



*202 MUNICH



205 FRANKFURT



221 AURORA



243 SUNRISE



*244 TWILIGHT



276 PLAZA



318 CAFE



319 HAMPTON



320 EMPIRE







345 TOKYO



*346 OSAKA

* Return-to-Door Lever Designs comply with California and other state building codes for door openings
Entry 3 digit lever design code for outside escutcheon

Images	Description	Part Number	Standard Finish
	Entry Function Mortise with Cylinder (ANSI 08)	EDES-XSF___EN	32D Satin Stainless Steel 19G Graphite Black 26D Satin Chrome
	Night Latch / Storeroom Function Mortise with Cylinder (ANSI 09)	EDES-XSF___NL	32D Satin Stainless Steel 19G Graphite Black 26D Satin Chrome
	Passage Function (ANSI 14)	EDES-XSF___BE	32D Satin Stainless Steel 19G Graphite Black 26D Satin Chrome
	Dummy Function (ANSI 02)	EDES-XSF___DM	32D Satin Stainless Steel 19G Graphite Black 26D Satin Chrome

For additional finish options not listed, contact Sales Department for MOQ and lead times

TRIM OPTIONS FOR RIM, SVR, LBR

Compatible with ED93/ED70 Exit Devices

THUMB-PIECE & PLATE TRIM

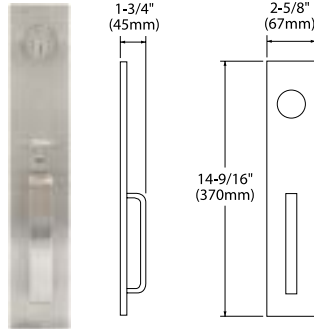

Plate Size 14-9/16" x 2-5/8"
(370mm x 67mm)

Cylinder Size 1-1/4" Mortise Cylinder
Entry & Storeroom function

Images	Description	Part Number	Standard Finish
	Entry Function Mortise with 1-1/4" Cylinder (ANSI 05)	EDTP10 EN	32D Satin Stainless Steel
	Night Latch Function Mortise with 1-1/4" Cylinder (ANSI 06)	EDTP10 NL	32D Satin Stainless Steel
	Night Latch RIM Function (ANSI 03)	EDPP10 NL	32D Satin Stainless Steel
	Passage Function (ANSI 15)	EDTP10 BE	32D Satin Stainless Steel
	Dummy Function (ANSI 02)	EDPP10 DM	32D Satin Stainless Steel

TRIM OPTIONS FOR CONCEALED VERTICAL ROD

Compatible with ED93 Exit Device

XSF TRIM WITH
DESIGN LEVER OPTIONS

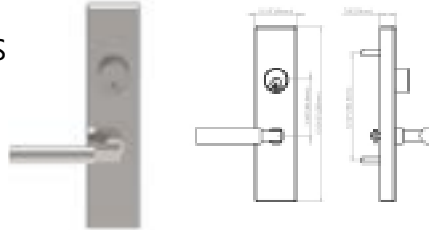

Escutcheon Size

2-1/2" x 10-9/16"
(64mm x 268mm)

Cylinder Size

1-1/4" Mortise Cylinder
Entry & Storeroom function



201 COLOGNE



*202 MUNICH



205 FRANKFURT



221 AURORA



243 SUNRISE



*244 TWILIGHT



276 PLAZA



318 CAFE



319 HAMPTON



320 EMPIRE



345 TOKYO



*346 OSAKA

* Return-to-Door Lever Designs comply with California and other state building codes for door openings
Entry 3 digit lever design code for outside escutcheon

Images	Description	Part Number	Standard Finish
	Entry Function Mortise with Cylinder (ANSI 08)	EDCV-XSF___EN	32D Satin Stainless Steel 19G Graphite Black 26D Satin Chrome
	Night Latch / Storeroom Function Mortise with Cylinder (ANSI 09)	EDCV-XSF___NL	32D Satin Stainless Steel 19G Graphite Black 26D Satin Chrome
	Passage Function (ANSI 14)	EDCV-XSF___BE	32D Satin Stainless Steel 19G Graphite Black 26D Satin Chrome
	Dummy Function (ANSI 02)	EDCV-XSF___DM	32D Satin Stainless Steel 19G Graphite Black 26D Satin Chrome

For additional finish options not listed, contact Sales Department for MOQ and lead times

TRIM OPTIONS FOR CONCEALED VERTICAL ROD

Compatible with ED93 Exit Device

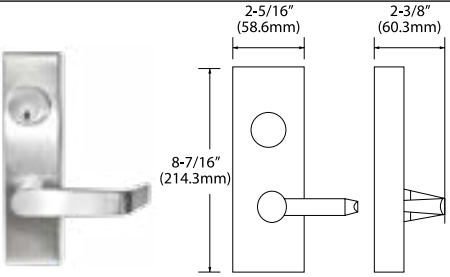
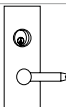
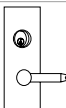
ESCUTCHEON TRIM				Escutcheon Size	8-7/16" x 2-5/16" (214mm x 58mm)
				Cylinder Size	1-1/4" Mortise Cylinder Entry & Storeroom function
Images	Description	Part Number	Standard Finish		
	Entry Function with 07 lever with Cylinder (ANSI 08)	ED93CES07 EN	26D Satin Chrome		
	Night Latch with 07 lever with Cylinder (ANSI 09)	ED93CES07 NL	26D Satin Chrome		

For additional finish options not listed, contact Sales Department for MOQ and lead times

TRIM OPTIONS FOR MORTISE EXIT DEVICE

Compatible with ED93 Exit Device

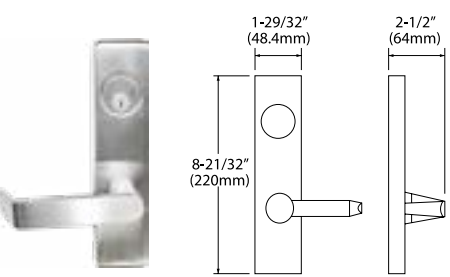
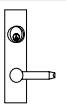
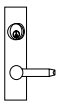
ESCUTCHEON TRIM				Escutcheon Size	8-21/32" x 1-29/32" (220mm x 48mm)
				Cylinder Size	1-1/4" Mortise Cylinder Entry & Storeroom function
Images	Description	Part Number	Standard Finish		
	Entry Function with 07 lever with Cylinder (ANSI 08)	ED93MES07 EN	26D Satin Chrome		
	Night Latch WITH 07 lever with Cylinder (ANSI 09)	ED93MES07 NL	26D Satin Chrome		

For additional finish options not listed, contact Sales Department for MOQ and lead times

TRIM OPTIONS FOR MORTISE EXIT DEVICE

Compatible with ED93 Exit Device

XSF TRIM WITH
DESIGN LEVER OPTIONS

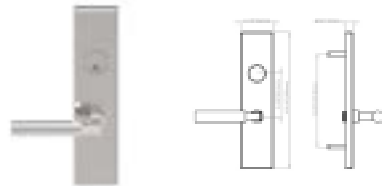

Escutcheon Size

2-1/2" x 10-9/16"
(64mm x 268mm)

Cylinder Size

1-1/2" Mortise Cylinder
Entry & Storeroom function



201 COLOGNE



*202 MUNICH



205 FRANKFURT



221 AURORA



243 SUNRISE



*244 TWILIGHT



276 PLAZA



318 CAFE



319 HAMPTON



320 EMPIRE







345 TOKYO



*346 OSAKA

* Return-to-Door Lever Designs comply with California and other state building codes for door openings
Entry 3 digit lever design code for outside escutcheon

Images	Description	Part Number	Standard Finish
	Entry Function Mortise with Cylinder (ANSI 08)	EDML-XSF___EN	32D Satin Stainless Steel 19G Graphite Black 26D Satin Chrome
	Night Latch / Storeroom Function Mortise with Cylinder (ANSI 09)	EDML-XSF___NL	32D Satin Stainless Steel 19G Graphite Black 26D Satin Chrome
	Passage Function (ANSI 14)	EDML-XSF___BE	32D Satin Stainless Steel 19G Graphite Black 26D Satin Chrome
	Dummy Function (ANSI 02)	EDML-XSF___DM	32D Satin Stainless Steel 19G Graphite Black 26D Satin Chrome

For additional finish options not listed, contact Sales Department for MOQ and lead times