



PD97PT-ATL Electrified Grade 1 Mortise Locks with Auto-locking for Sliding Doors

- Motor Driven 12/24V electrified lock for sliding doors
- Built-in DPS & DBM sensors, enabling auto-latching and auto-locking functions
- Supports touchless opening solutions when paired with an auto-operator
- Fail-Secure lock remains mechanically locked during power failure, ensuring security
- Designed for easy integration with any type of access control systems

SPECIFICATIONS

Door Thickness	1-3/4" (45mm) Standard
	1-3/8" (35mm) Thin Door Kit available for XGT only
	2" to 2-1/4" (50mm to 57mm) Thick Door Kit available
Backset	2-3/4" (70mm) 2-1/2" (63.5mm)
Lever Spindle	8 x 8mm square
Thumbturn Spindle	5 x 5mm square
Center to Center Distance	Lever to Cylinder: 3-7/8" (98mm)
	Lever to thumbturn: 2-11/16" (68mm)
Handing	Specify handing when ordering
Cylinder	Schlage C keyway 6 pin, 1-1/4" mortise cylinder with 2 keys (standard) optional SFIC and LFIC housing and cores available
CAM	CAM01-SCL Clover Cam
Material	Trim: Stainless Steel
	Lockcase: Heavy gauge Steel
	Bolt: Brass and Stainless Steel
	Faceplate/Strike: Stainless Steel
	Cylinder: Solid Brass

ELECTRICAL SPECIFICATIONS

Maximum current for individual parts when in operation at 12/24V:

Lock Body	560 mA
Strike	40 mA
Keypad	90mA
Handwave	30 mA
Relay	30 mA



CODE COMPLIANCE

- UL1034 Burglary-Resistant Electric Locking Mechanisms
- UL294 Standard for Access Control System Units
- ANSI/BHMA A156.25 Electrified Mortise Locks
- ANSI/BHMA A156.18 Finishes
- ANSI A117.1 ADA Accessibility
- Meets ANSI/BHMA Grade 1 Standards

FINISH

- 32D Satin Stainless Steel, 32 Bright Stainless Steel
- CeraMax Ceramic Coating - C19G Graphite Black, C19 Flat Black, CGY Stormy Grey, CDB Dark Bronze
- Please see Finish Solutions on INOX Website for special order finishes

PD97PT-ATL ELECTRIFIED MORTISE LOCK WITH AUTO-LOCKING

FUNCTION

PD97PT-ATL Functions are **Fail Secure** except for Passage. In all other functions, deadbolt auto-locks once door is closed; during power failure, deadbolt remains mechanically locked from outside.

PD97PT-ATL includes the following monitoring sensors:

- DBM = Deadbolt Monitoring Switch
- DPS = Door Position Switch

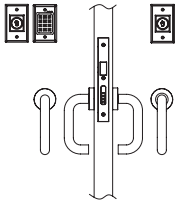

Passage: PD97PT-ATL10

- Latchbolt projected/retracted by built-in stepper motor when energized by 12/24V DC power transferred through contacts on lock and strike
- Levers are active at all times

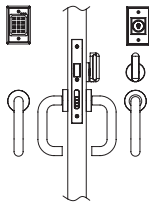

Patio/Exit: PD97PT-ATL60

- Deadbolt projected/retracted by built-in stepper motor when energized by 12/24V DC power transferred through contacts on lock and strike
- Thumbturn inside throws/retracts deadbolt to lock/unlock door
- Outside lever is rigid at all times
- Inside lever always unlocks deadbolt for emergency egress

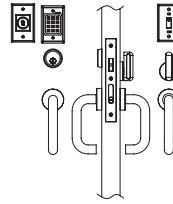

Entry/Office: PD97PT-ATL53

- Latchbolt projected/retracted by built-in stepper motor when energized by 12/24V DC power transferred through contacts on lock and strike
- Key from outside to throw/retract latchbolt to lock/unlock door
- Thumbturn inside throws/retracts latchbolt to lock/unlock door
- Outside lever is rigid at all times
- Inside switch used to activate or deactivate outside handwave; when door is locked and handwave deactivated, entrance by key only
- Inside lever always unlocks latchbolt for emergency egress

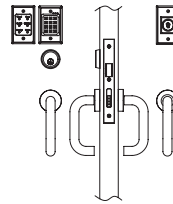

Storeroom: PD97PT-ATL80

- Latchbolt projected/retracted by built-in stepper motor when energized by 12/24V DC power transferred through contacts on lock and strike
- Key from outside to throw/retract latchbolt to lock/unlock door
- Door cannot be locked from inside
- Outside lever is rigid at all times
- Inside lever always unlocks latchbolt for emergency egress

FUNCTION TABLE

	Entry / Office	Storeroom	Passage	Patio/Exit
Outside Lever	×	×	×	×
Inside Lever	×	×	×	×
Lockcase	×	×	×	×
Cylinder	×	×		
Inside Thumbturn	×			×
Optional Accessories				
Switch	×			
Power Supply	×	×	×	×
Keypad w/Built-in Relay	×	×	×	×
Push Button	×	×	×	×
Handwave	×	×	×	×

PD97PT-ATL ELECTRIFIED MORTISE LOCK WITH AUTO-LOCKING

COMPONENTS

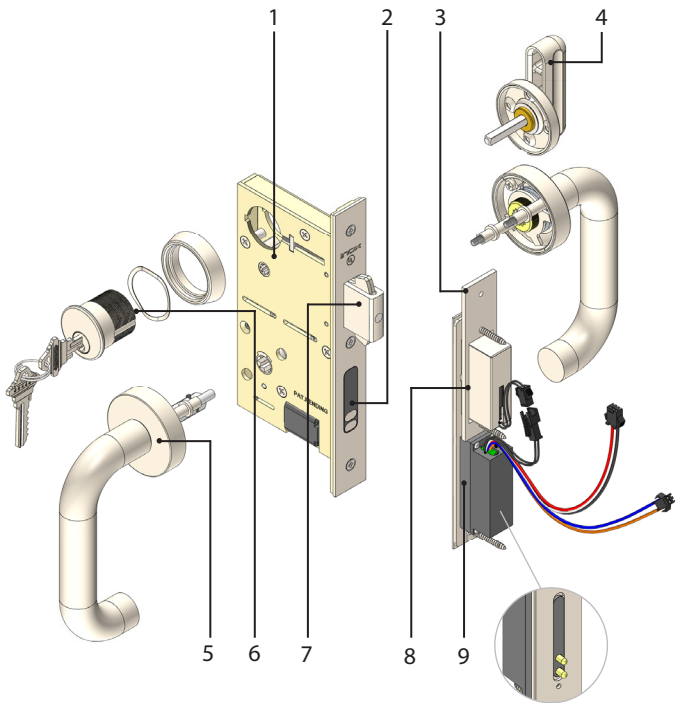

Description

- 1 PD97PT-ATL lockcase and faceplate;
2-3/4" backset **PD97ATL-234-CASE** or 2-1/2" backset
PD97ATL-212-CASE
- 2 Faceplate contacts; Auto-locking Door Positioning
Switches and Power Transfer
- 3 Strike with reinforcement plate for door frame
- 4 **TT07-ADA** ADA Compliant thumbturn
- 5 Heavy-duty Stainless Steel cast rose with choice of
X Series lever design
- 6 Schlage C keyway, 6 pin 1-1/4" mortise cylinder
CMB1146
- 7 1" (25.4mm) heavy-duty brass bolt throw with
self-retracting non-marring hooks
- 8 Dust box with DBM (Deadbolt Sensor)
- 9 Power Transfer Strike with spring-loaded prongs
LSR-PD97ATL-STRK 6-9/16"x1"x3/16"

Optional INOX Access Control Accessories

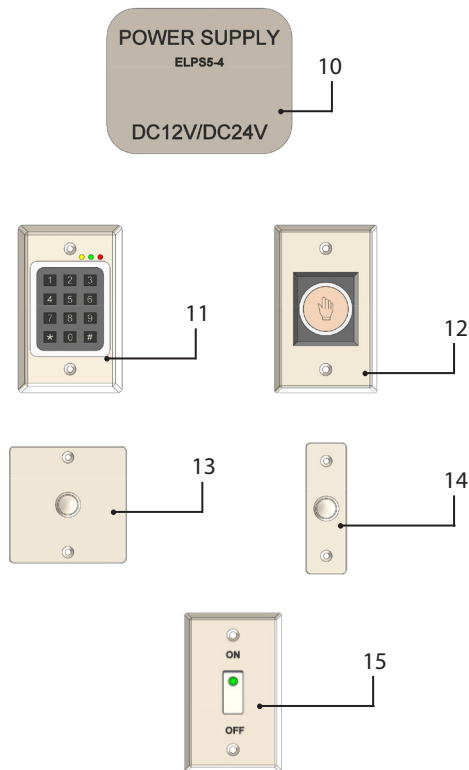

Optional Accessories, use the part numbers below as new line items.

- INX-ELPS5-4** Power Supply with built-in surge protection, Voltage: 2A@12/24V DC, Dimension: 11"x11"x4"
- 11 **AC-KP1200** Stainless Steel keypad faceplate for indoor electrically locked door application, Voltage: 12/24V DC, Dimension: 4-1/2"x2-3/4"x1-1/4"
- 12 **AC-IR1100** Handwave sensor with illuminated display, Voltage: 2A@12/24V DC, Dimension: 4-1/2"x2-3/4"x1"
- 13 **AC-PB200** Wide Push Button with illuminated display, Dimension: 3-3/8"x3-3/8"x3/4"
- 14 **AC-PB100** Narrow Push Button with no illuminated display, Dimension: 3-1/2"x1-1/8"x1"
- 15 **AC-SW32** On/Off switch for Exterior Handwave on PT-ATL53, Dimension: 4-1/2" x 2-3/4"

PD97PT-ATL ELECTRIFIED MORTISE LOCK WITH AUTO-LOCKING

DIMENSIONS

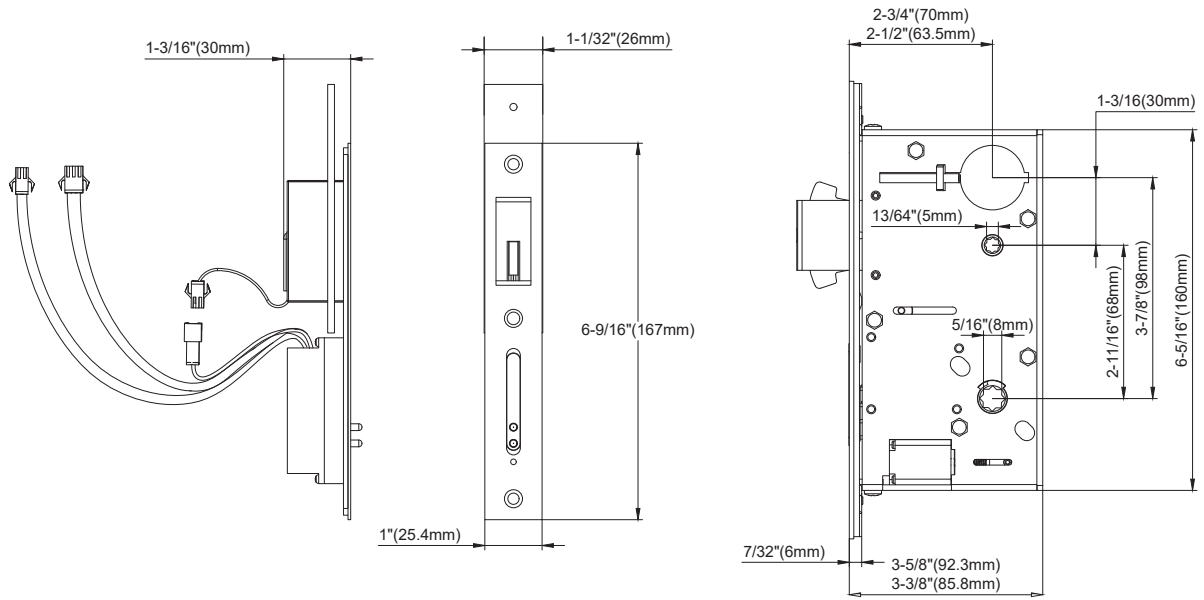

WIRING DIAGRAM

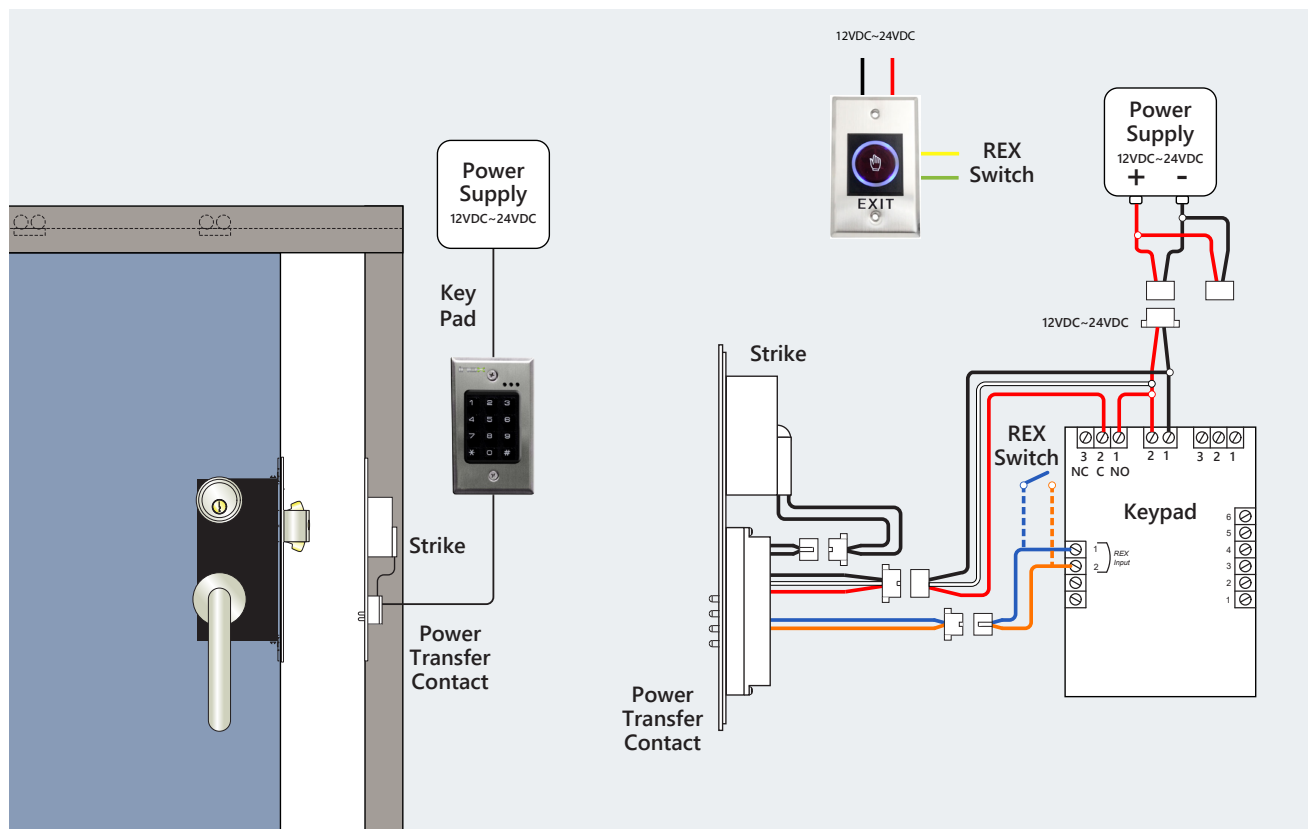

PD97PT-ATL ELECTRIFIED MORTISE LOCK WITH AUTO-LOCKING

ROSE & LEVER DESIGN



XGT Rose



XGS Rose

*Return-to-Door Lever Designs comply with California and other state building codes for door openings



201 COLOGNE



202 MUNICH*



205 FRANKFURT



221 AURORA



243 SUNRISE



244 TWILIGHT*



276 PLAZA



318 CAFE



319 HAMPTON



320 EMPIRE



345 TOKYO



346 OSAKA*

THUMBTURN OPTIONS

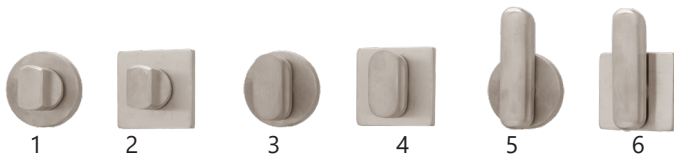

Ref.	Description	Part Number
1	TT02 Thumbturn in Round Rosette	EC-R460TT02
2	TT02 Thumbturn in Square Rosette	EC-S420TT02
3	TT04 Thumbturn in Round Rosette	EC-R460TT04
4	TT04 Thumbturn in Square Rosette	EC-S420TT04
5	ADA TT07 Thumbturn in Round Rosette	EC-R460TT07-ADA
6	ADA TT07 Thumbturn in Square Rosette	EC-S420TT07-ADA

PD97PT-ATL ELECTRIFIED MORTISE LOCK WITH AUTO-LOCKING

ELECTRIFIED LOCKS COMPARISON

Trim	PD97	PD97PT	PD97PT-ATL	PD97ES
X Series Trim	x	x	x	x
Outside Surface Pull with Inside Lever for Egress	x	x	x	x
Performance Capabilities				
Touchless Unlocking	x	x	x	x
Built-in Power Transfer within Lockset		x	x	x
Self-latching/Auto-latching *			x	x
Auto-locking			x	x
Compliance Certification				
UL294 Safety and Security for Access Control System		x	x	x
UL1784 Air Leakage Test for Draft, Smoke Door Assembly			x	x
UL1034 Burglary Resistant Electric Lock Mechanism	x	x	x	x
ANSI/BHMA A156.25 Electrified Locking Device	x	x	x	x

* Passage or Office Function only



HOW TO ORDER A MORTISE LOCK FOR SLIDING DOOR

HOW TO ORDER LOCKSETS

Use the sequence below to order mortise locksets specification. Please see price book for parts or additional service upcharge.

Rose	Lever	Lock	Function	Backset	Cylinder	Thumbturn	Finish	Handing
XGT	243	-PD97PT-ATL	53	A	CMB1146	GT04	32D	LH
1	2	3	4	5	6	7	8	9

ROSE



XGT XGS

LEVER

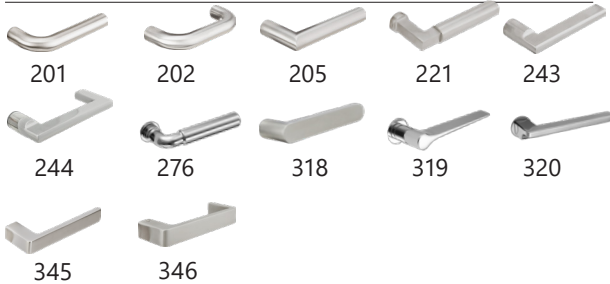

201

202

205

221

243

244

276

318

319

320

345

346

LOCK

PD97PT-ATL

FUNCTION

10 Passage
53 Entrance
60 Patio
80 Storeroom

5 BACKSET

Backset Blank = 2-3/4"

Backset A = 2-1/2"

6 CYLINDER



CMB1146

1-1/4" Cylinder, 6 pin

EC-R460COL *Round Collar*
EC-S420COL *Square Collar*

CMB1186

1-1/8" Cylinder 6 Pin

No Collar Required

CMB1386

1-3/8" Cylinder, 6 pin

EC-R417COL *Round Collar*
EC-S420COL + EC-R456COL *Square Collar*



CMB1146-ICBA-HUS

1-1/4" SFIC housing, 6 pin

EC-R460COL *Round Collar*
EC-S420COL *Square Collar*



CMB1387-ICBA-HUS

1-3/8" SFIC housing, 7 pin

EC-R417COL *Round Collar*
EC-S420COL + EC-R456COL *Square Collar*

CMB112-LFIC-HUS

1-1/2" LFIC housing, 6 pin

EC-R417COL *Round Collar*
EC-S420COL + EC-R456COL *Square Collar*

7 THUMBTURN



GT02



GT04



GT07



GS02



GS04



GS07

8 FINISH

Standard:



32D



C19G



C19



CGY



CDB

Special Order:



32



PVD4

9 HANDING

RH = Right Hand LH = Left Hand