



# PD9600 Series

## Self-Latching / Self-Locking Mortise Locks for Sliding Doors

- Locking solutions for all major functions of commercial openings
- Built-in mechanical self-latching or self-locking
- Meets and exceeds ANSI/BHMA 156.36 standard
- Emergency Egress via inside lever
- ADA Compliant Trim

### SPECIFICATIONS

<b>Door</b>	1-3/4" (45mm) Standard
<b>Thickness</b>	1-3/8" (35mm) Thin Door Kit <i>available for XGT only</i> 2" to 2-1/4" (50mm to 57mm) Thick Door Kit available
<b>Backset</b>	2-3/4" (70mm) 2-1/2" (63.5mm)
<b>Lever Spindle</b>	8 x 8mm square
<b>Thumbturn Spindle</b>	5 x 5mm square
<b>Center to Center Distance</b>	Lever to cylinder: 3-7/8" (98mm) Lever to thumbturn: 2-11/16" (68mm)
<b>Handing</b>	Specify handing when ordering
<b>Cylinder</b>	Schlage C keyway 6 pin, 1-1/4" mortise cylinder with 2 keys (standard). SFIC and LFIC housing and cores available
<b>CAM</b>	CAM01-SCL Clover Cam <i>all functions except Storeroom</i>
<b>Material</b>	Trim: Stainless Steel Lockcase: Heavy gauge Steel Bolt: Brass and Stainless Steel Faceplate/Strike: Stainless Steel Cylinder: Solid Brass

### CODE COMPLIANCE



- ANSI A117.1 Accessibility Code (ADA Compliant)
- Meets and exceeds ANSI/BHMA 156.36 Grade 1 Auxiliary Hardware standard
- UL1784 Standard for Safety Air Leakage test of Door Assemblies and Openings

### FINISH

- MicroArmor® Antimicrobial Coating that uses silver ions to destroy up to 99.99% of bacteria
- 32D Satin Stainless Steel
- 32 Bright Stainless Steel
- 19G Graphite Black
- PVD4 Satin Brass available in 205, 221, 243, 244, 276, 318, 319, 320, 321, 345, 346 and 509
- CeraMax Ceramic Coating: C19G Graphite Black, C19 Flat Black, CGY Stormy Grey, CDB Dark Bronze
- Please see Finish Solutions on INOX website for special order finishes

### APPLICATION

INOX PD96 is a commercial grade lock with built-in mechanical self-latching/self-locking functions.

Available in multiple ANSI/BHMA functions, PD96 is suited for a wide range of applications including but not limited to: Hospitality, Healthcare, Commercial, Class A Office, and high-end Residential.

FEATURES

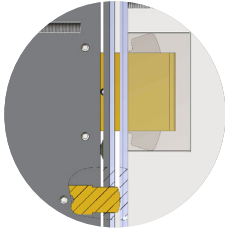

**Self-latching / Self-locking**

- Self-latching: When sliding door is closed, deadbolt is automatically engaged into strike. Lever retracts deadbolt to unlatch.
- Self-locking: When sliding door is closed, deadbolt is automatically engaged into strike. Outside lever is in locked position, keeping door locked from outside. Key or inside thumbturn unlocks outside lever and unlocks deadbolt. Inside lever always allows emergency egress.

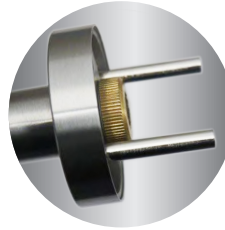

**X Series Trim**

- Heavy-duty wire torsion spring.
- Cast stainless steel sub-rose with knurled brass nut for mechanical integrity and strength.



**ADA Accessibility**

- ADA compliant trim.

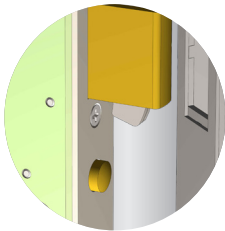

**Actuator**

- The extended release button is built onto the faceplate of the lock.
- Once the door is closed, the release button is activated, which then triggers the deadbolt into the strike.

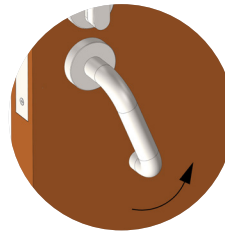

**Emergency Egress**

- Single action emergency egress for life safety and code compliance.

FUNCTION

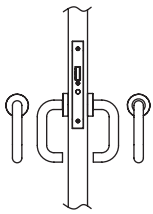

**Passage 10**

- Actuator button on faceplate contacts strike and automatically engages deadbolt when sliding door closes
- No thumbturn or keyed cylinder
- Outside and inside levers are active and can retract deadbolt

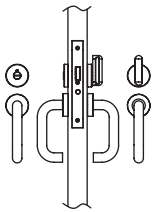

**Privacy with Indicator 40**

- Actuator button on faceplate contacts strike and automatically engages deadbolt when sliding door closes
- Outside lever is rigid when locked and cannot retract deadbolt
- Outside lever can retract deadbolt when unlocked
- Inside thumbturn can lock or unlock outside lever
- Outside coin turn emergency release can also unlock outside lever
- Operating inside lever to retract deadbolt **simultaneously** resets outside lever and inside thumbturn to unlocked position
- Inside lever can always retract deadbolt for emergency egress

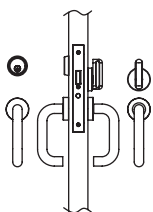

**Inner Entry 50**

- Actuator button on faceplate contacts strike and automatically engages deadbolt when sliding door closes
- Outside lever locked or unlocked by key or inside thumbturn
- Outside lever is rigid when locked and cannot retract deadbolt
- Outside lever retracts deadbolt when unlocked
- Operating inside lever for egress **simultaneously** resets outside lever and inside thumbturn to unlocked position
- Inside lever can always retract deadbolt for emergency egress

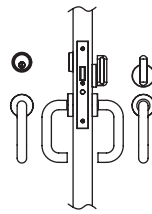

**Entrance 53**

- Actuator button on faceplate contacts strike and automatically engages deadbolt when sliding door closes
- Outside lever locked or unlocked by key or inside thumbturn
- Outside lever is rigid when locked and cannot retract deadbolt
- Outside lever retracts deadbolt when unlocked
- Outside lever will remain in locked or unlocked position until user resets status with key or inside thumbturn
- Operating inside lever will **not** change the locked or unlocked status of the outside lever or inside thumbturn
- Inside lever can always retract deadbolt for emergency egress

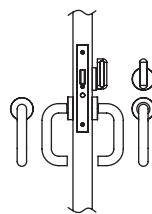

**Patio 60**

- Actuator button on faceplate contacts strike and automatically engages deadbolt when sliding door closes
- Outside lever is locked or unlocked by inside thumbturn
- Outside lever is rigid when locked and cannot retract deadbolt
- Outside lever can retract deadbolt when unlocked
- No keyed cylinder outside; door cannot be opened from outside when locked
- Operating inside lever to retract deadbolt **simultaneously** resets outside lever and inside thumbturn to unlocked position
- Inside lever can always retract deadbolt for emergency egress

FUNCTION

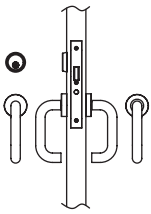

**Classroom 70**

- Actuator button on faceplate contacts strike and automatically engages deadbolt when sliding door closes
- Outside lever is locked or unlocked only by key
- Outside lever is rigid when locked and cannot retract deadbolt
- Outside lever retracts deadbolt when unlocked
- No thumbturn on inside
- Operating inside lever for egress will **not** change the locked or unlocked status of outside lever
- Inside lever can always retract deadbolt for emergency egress

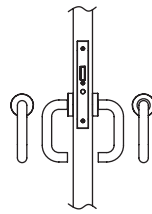

**Exit 90**

- Actuator button on faceplate contacts strike and automatically engages deadbolt when sliding door closes
- Outside lever is always rigid and locked and cannot retract deadbolt
- No cylinder outside, no thumbturn inside
- Inside lever can always retract deadbolt for emergency egress

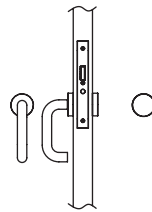

**Communicating 92**

- Actuator button on faceplate contacts strike and automatically engages deadbolt when sliding door closes
- Inside Lever retracts deadbolt
- Blank rosette on outside

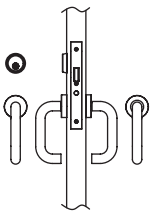

**Storeroom 80**

- Actuator button on faceplate contacts strike and automatically engages deadbolt when sliding door closes
- Outside lever is locked or unlocked only by key
- Outside lever is rigid when locked and cannot retract deadbolt
- Outside lever retracts deadbolt when unlocked
- Key cannot be removed from cylinder when outside lever is unlocked; key can only be removed when outside lever is in locked position. *Requires special CAM*
- No thumbturn on inside
- Operating inside lever will **not** change locked status of outside lever
- Inside lever can always retract deadbolt for emergency egress

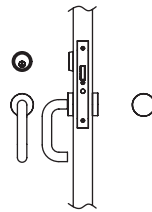

**Security Communicating 95**

- Keyed function for connected rooms with security; only an authorized user may lock/unlock from the inside of the room, e.g. hotel staff
- Actuator button on faceplate contacts strike and automatically engages deadbolt when sliding door closes
- Inside lever is locked or unlocked by a key
- Inside lever can retract deadbolt when unlocked
- Inside lever is rigid when key locks the lever
- Blank rosette on outside

# PD9600 SELF-LATCHING MORTISE LOCK FOR SLIDING DOORS

## COMPONENTS

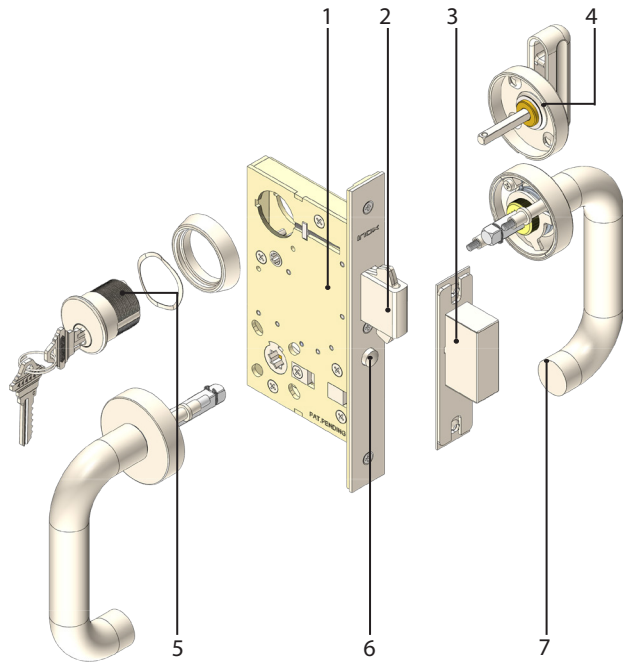

### Description

- 1 PD9600 Series Lockcase
- 2 1" (25.4mm) heavy-duty brass bolt throw with self-retracting non-marring hooks
- 3 Adjustable strike for deadbolt; up to 1/4" vertical adjustability (6.35mm)
- 4 ADA Compliant thumbturn
- 5 Schlage C keyway, 6 pin 1-1/4" mortise cylinder
- 6 Actuator to activate self-latching/self-locking feature
- 7 Heavy-duty stainless steel cast rose with choice of X Series lever design

## FUNCTION TABLE

	Code	Inside Lever	Outside Lever	Lockcase	Cylinder	Coin Turn	Thumbturn
Passage	10	✓	✓	✓	✗	✗	✗
Privacy w/ Indicator	40	✓	✓	✓	✗	✓	✓
Inner Entry	50	✓	✓	✓	✓	✗	✓
Entrance	53	✓	✓	✓	✓	✗	✓
Patio	60	✓	✓	✓	✗	✗	✓
Classroom	70	✓	✓	✓	✓	✗	✗
Storeroom	80	✓	✓	✓	✓	✗	✗
Exit	90	✓	✓	✓	✗	✗	✗
Communicating	92	✓	✗	✓	✗	✗	✗
Security Communicating	95	✓	✗	✓	✓	✗	✗

# PD9600 SELF-LATCHING MORTISE LOCK FOR SLIDING DOORS

## LOCK DIMENSIONS

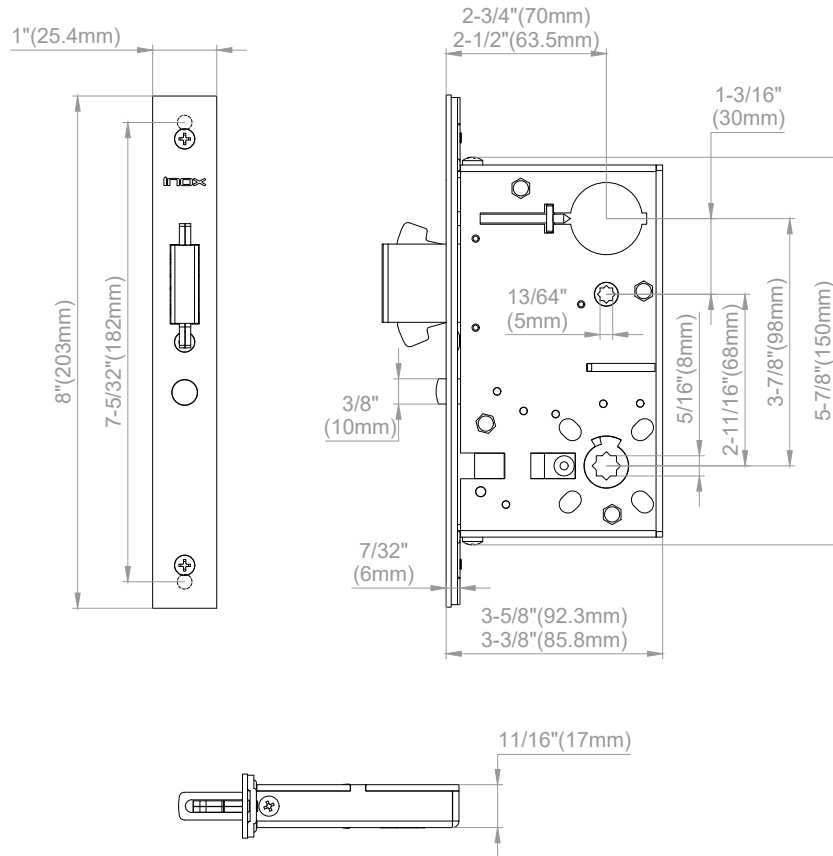

## HANDING

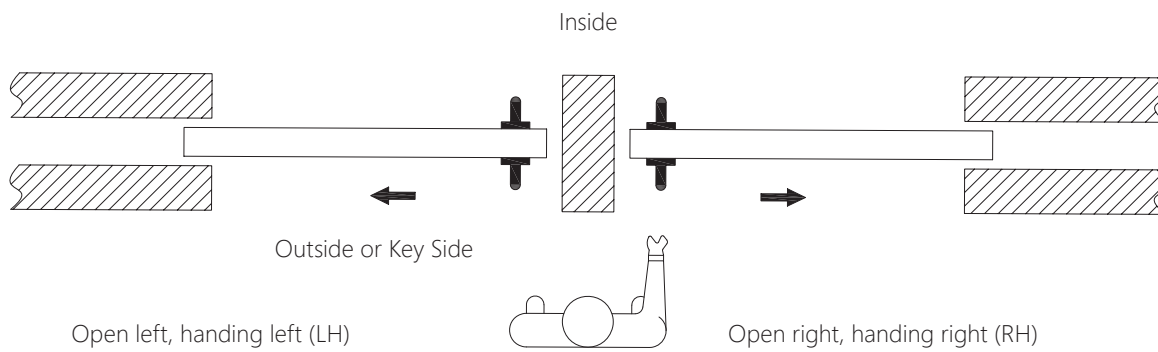

## SLIDING DOOR HANDING

- Handing refers to the direction the door slides open. Example: If the door slides to the left to open, it is a left-handed door.
- Determine door direction from the exterior or key side of the door when facing into the room.

# TRIM AND THUMBTURN OPTIONS

## ROSE & LEVER DESIGN



XGT Rose



XGS Rose

\*Return-to-Door Lever Designs comply with California and other state building codes for door openings



201 Cologne



202 Munich\*



205 Frankfurt



221 Aurora



243 Sunrise



244 Twilight\*



276 Plaza



318 Café



319 Hampton



320 Empire



321 Valencia\*



345 Tokyo



346 Osaka\*



509 Stuttgart\*

## THUMBTURN & RELEASE



**EC-R560TT07PVSW-ADA (GR)**

TT07 Thumbturn with coin release and indicator



**EC-R560TT04PVSW (GR)**

TT04 Thumbturn with coin release and indicator

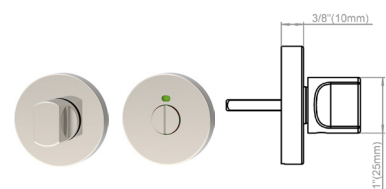

















**EC-R560TT02PVSW (GR)**

TT02 Thumbturn with coin release and indicator

# HOW TO ORDER MORTISE LOCKS FOR SLIDING DOORS

## HOW TO ORDER STANDARD LOCKSETS

To order locksets with a non-standard specification, please describe the additional requirements in the same sequence as below. Please see price book for parts or additional service upcharge.

Rose	Lever	Lock	Function	Backset	Cylinder	Thumbturn	Finish	Handing
<b>XGT</b>	<b>243</b>	<b>-PD96</b>	<b>53</b>	<b>A</b>	<b>-S6</b>	<b>-GR4</b>	<b>-32D</b>	<b>-LH</b>
<b>1</b>	<b>2</b>	<b>3</b>	<b>4</b>	<b>5</b>	<b>6</b>	<b>7</b>	<b>8</b>	<b>9</b>
<b>ROSE</b>	<b>LEVER</b>	<b>LOCK</b>			<b>FUNCTION</b>			
 								
XGT XGS	201	202	205	221	243			
								
	244	276	318	319	320			
								
	321	345	346	509				

### 5 BACKSET

Backset Blank = 2-3/4"

Backset A = 2-1/2"

### 6 CYLINDER AND HOUSING (includes collar)

LC = Less Cylinder



Blank = Standard Mortise 1-1/4" Cylinder



-S6 = Small Format Interchangeable Cylinder (SFIC) Housing 1-1/4", 6-Pin, Less Core, L Clover Cam

-S7 = Small Format Interchangeable Cylinder (SFIC) Housing 1-3/8", 7-Pin, Less Core, L Clover Cam

-L6 = Large Format Interchangeable Cylinder (LFIC) Housing 1-1/2", 6-Pin, Less Core, L Clover Cam



Order IC Cores and Thick Door Kits (TDKs) separately

### 7 THUMBTURN



GR02  
GT02  
GS02  
SR02



GR04  
GT04  
GS04  
SR04



Blank = GR07  
GT07  
GS07  
SR07



### 8 FINISH

Standard:



-32D



-C19G



-C19



-CGY

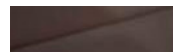

-CDB



-32



-PVD4



-19G

PVD4 is available for 205, 221, 243, 244, 276, 318, 319, 320, 321, 345, 346 and 509 lever designs.

### 9 HANDING

-RH = Right Hand

-LH = Left Hand