

# Sliding, Pocket & Barn Door Locks



**PD9500**

**PD9600**

**PD3000**

**PD8000**

**PD5000**

**PD2000**

**BD4000**

**BD1000**

**WS90/WS90L**

# CONTENTS

---

<b>Page 02</b>	PD9500 Mortise Lock for Sliding Doors with Emergency Egress
<b>Page 03</b>	PD9500 Components and Dimensions
<b>Page 04</b>	PD9500 Functions
<b>Page 05</b>	PD9600 Self-latching Mortise Lock for Sliding Doors
<b>Page 06</b>	PD9600 Features
<b>Page 07</b>	PD9600 Components and Dimensions
<b>Page 08</b>	PD9600 Functions
<b>Page 10</b>	PD9500 & PD9600 Rose and Lever Designs
<b>Page 11</b>	PD9500 & PD9600 Thumbturn Options
<b>Page 12</b>	PD9500 & PD9600 Faceplate and Strike
<b>Page 13</b>	PD9500 Series How to Order
<b>Page 14</b>	PD9600 Series How to Order
<b>Page 15</b>	PD3000 Narrow Profile ICU Lock for Sliding Doors
<b>Page 16</b>	PD3000 Components and Dimensions
<hr/>	
<b>Page 18</b>	PD8000 Mortise Lock for Sliding or Pocket Doors
<b>Page 19</b>	PD8000 Components and Dimensions
<b>Page 20</b>	PD8000 Functions
<b>Page 21</b>	PD5000 Mortise Lock for Sliding or Pocket Doors
<b>Page 22</b>	PD5000 Components and Dimensions
<b>Page 23</b>	PD5000 Functions
<b>Page 24</b>	Thumbturn Options for PD5000 & PD8000
<b>Page 27</b>	FH17 Bezel Flush Pull
<b>Page 28</b>	FH27/FH27SL Linear Flush Pull
<b>Page 29</b>	FH29 Arc Flush Pull
<b>Page 30</b>	FH31 Regal Flush Pull
<b>Page 31</b>	FH32 Crown Flush Pull
<b>Page 32</b>	FH22 Luna Flush Pull
<b>Page 33</b>	FH22CF Luna Concealed Fixing Flush Pulls
<b>Page 34</b>	FH23 Urban Flush Pull
<b>Page 35</b>	FH23CF Urban Concealed Fixing Flush Pulls
<b>Page 36</b>	PD2000 Twistlock Edge Pull Privacy Lock
<b>Page 37</b>	PD8000/PD5000 Faceplate and Strike
<b>Page 40</b>	PD8000 How to Order
<b>Page 41</b>	PD5000 How to Order
<b>Page 43</b>	PD2000 How to Order
<hr/>	
<b>Page 45</b>	BD4000 Concealed Jamb Mount Barn Door Privacy Lock
<b>Page 47</b>	BD4000 Flush Trim Barn Door Privacy Lock
<b>Page 48</b>	BD4000 Concealed Jamb Mount for Metal Studs Barn Door Privacy Lock
<b>Page 49</b>	BD4000 Privacy Lock Trim Options
<b>Page 50</b>	BD4000 How to Order
<b>Page 51</b>	BD1000 Surface Mount Barn Door Privacy Lock
<hr/>	
<b>Page 52</b>	WS90 Wall Strike for Lockable Barn Doors
<b>Page 53</b>	WS90L Large Wall Strike for Lockable Barn Doors
<b>Page 55</b>	ADA Surface Pulls
<b>Page 56</b>	ADA Pull Options
<b>Page 58</b>	Mortise Cylinders and Keys

Disclaimer: All information in this catalog has been deemed accurate as of the date of printing. We are continuously improving and expanding our line in an effort to offer our clients the finest quality products and services; therefore, Unison Hardware, Inc., reserves the right to alter this information or correct printing errors at any time.

©2023 Unison Hardware, Inc. All Rights Reserved. V20230516

## PD9500, PD9600 & PD3000 MORTISE LOCKS for Sliding Doors



PD9500 with XGS205 Frankfurt



PD9600 with XGT243 Sunrise



PD3000 with NE502 Munich

# PD9500 MORTISE LOCK

## for Sliding Doors with Emergency Egress



### SPECIFICATIONS

<b>Door Thickness</b>	1-3/4" (45mm) Standard 1-3/8" (35mm) Thin Door Kit available for XGT only 2" to 2-1/4" (50mm to 57mm) Thick Door Kit available
<b>Backset</b>	2-3/4" (70mm) 2-1/2" (63.5mm)
<b>Lever Spindle</b>	8 x 8mm square
<b>Thumbturn Spindle</b>	5 x 5mm square
<b>Center to Center Distance</b>	Lever to Cylinder: 3-7/8" (98mm) Lever to Thumbturn: 2-11/16" (68mm)
<b>Cylinder</b>	Schlage C keyway 6 pin, 1-1/4" mortise cylinder with 2 keys (standard). Optional SFIC and LFIC housing and cores available
<b>CAM</b>	CAM01-SCL Clover Cam
<b>Material</b>	Trim: Stainless Steel Lockcase: Heavy Gauge Steel Bolt: Brass and Stainless Steel Faceplate/Strike: Stainless Steel Cylinder: Solid Brass

### FEATURES

- Form meets function with 12 designer trims, five function options, and a variety of available finishes
- Patented anti-binding winged deadbolt provides smooth operation for safety and security
- Single-action deadbolt release for emergency egress
- Adjustable strike aids door and frame alignment for easier installation
- ADA compliant trim

### CODE COMPLIANCE

- ANSI/BHMA A156.36 Auxiliary Locks
- ANSI/BHMA A156.18 Finishes
- ANSI A117.1 ADA Accessibility

### STANDARD FINISHES

- 32D Satin Stainless Steel
- 32 Bright Stainless Steel
- PVD4 Satin Brass (243, 267 and 321 Lever Design)
- CeraMax Ceramic Coating: C19G Graphite Black, C19 Flat Black, CGY Stormy Grey, CDB Dark Bronze

*For additional finish options not listed, contact Sales Department for MOQ and lead times*

# PD9500 COMPONENTS AND DIMENSIONS

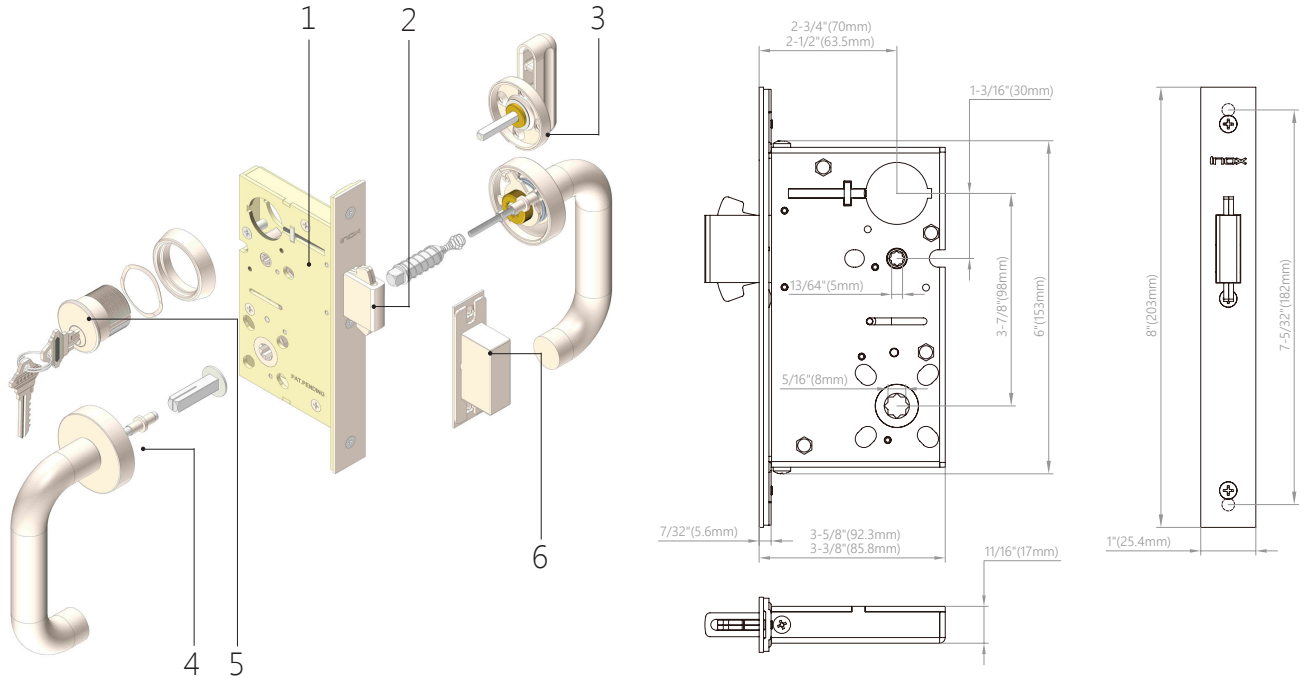

## Description

- 1 Lockcase and faceplate; 2-3/4" backset or 2-1/2" backset
- 2 1" (25.4mm) heavy-duty brass bolt throw with self-retracting non-marring hooks
- 3 ADA Compliant thumbturn
- 4 Heavy-duty Stainless Steel cast rose with choice of X Series lever design
- 5 Schlage C keyway, 6 pin 1-1/4" mortise cylinder
- 6 Adjustable strike for deadbolt; up to 1/4" vertical adjustability (6.35mm)

# PD9500 FUNCTIONS

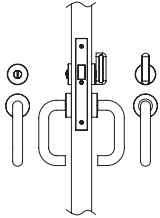

### Privacy: PD9540

- Deadbolt can be retracted by inside lever or outside emergency coin release
- Thumbturn inside locks and unlocks deadbolt
- Outside lever is rigid at all times
- Inside lever can always retract deadbolt for emergency egress

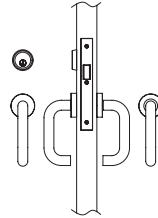

### Classroom: PD9570

- Deadbolt can be locked or unlocked by outside key
- No thumbturn on inside
- Outside lever is rigid at all times
- Inside lever can always retract deadbolt for emergency egress

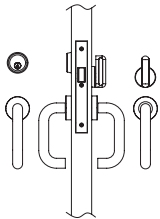

### Entry/Office : PD9550

- Deadbolt can be retracted or engaged by inside thumbturn or outside key
- Outside lever is rigid at all times
- Inside lever can always retract deadbolt for emergency egress

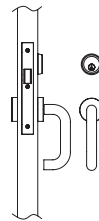

### Security Communicating: PD9595

- Keyed function provides security for connected rooms; only an authorized user (e.g., hotel staff) can lock/unlock with key
- Unlocking deadbolt with key allows door to be opened from lever side
- Lever is always rigid
- No lever on opposite side from cylinder; blank or blind rosette only

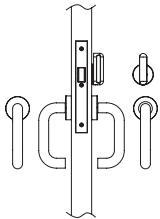

### Patio: PD9560

- Inside thumbturn locks or unlocks deadbolt
- Outside lever is rigid at all times
- No keyed cylinder outside; door cannot be opened from outside when locked
- Inside lever can always retract deadbolt for emergency egress

# PD9600 SELF-LATCHING MORTISE LOCK

## for Sliding Doors



### SPECIFICATIONS

<b>Door Thickness</b>	1-3/4" (45mm) Standard 1-3/8" (35mm) Thin Door Kit available for XGT only 2" to 2-1/4" (50mm to 57mm) Thick Door Kit available
<b>Backset</b>	2-3/4" (70mm) 2-1/2" (63.5mm)
<b>Lever Spindle</b>	8 x 8mm square
<b>Thumbturn Spindle</b>	5 x 5mm square
<b>Center to Center Distance</b>	Lever to Cylinder: 3-7/8" (98mm) Lever to Thumbturn: 2-11/16" (68mm)
<b>Cylinder</b>	Schlage C keyway 6 pin, 1-1/4" mortise cylinder with 2 keys (standard). Optional SFIC and LFIC housing and cores available
<b>CAM</b>	CAM01-SCL Clover Cam
<b>Material</b>	Trim: Stainless Steel Lockcase: Heavy Gauge Steel Bolt: Brass and Stainless Steel Faceplate/Strike: Stainless Steel Cylinder: Solid Brass

### FEATURES

- Dynamic locking solutions for all major functions of commercial openings, plus designer trim and a variety of available finishes
- Built-in mechanical self-latching or self-locking
- Meets and exceeds ANSI/BHMA 156.36 standard
- Emergency Egress via inside lever
- ADA Compliant trim



### CODE COMPLIANCE

- UL1784 Standard for Safety Air Leakage test of Door Assemblies and Openings
- ANSI/BHMA A156.18 Finishes
- ANSI A117.1 ADA Accessibility

### STANDARD FINISHES

- 32D Satin Stainless Steel
- 32 Bright Stainless Steel
- PVD4 Satin Brass (243, 267 and 321 Lever Design)
- CeraMax Ceramic Coating: C19G Graphite Black, C19 Flat Black, CGY Stormy Grey, CDB Dark Bronze

*For additional finish options not listed, contact Sales Department for MOQ and lead times*

## PD9600 FEATURES

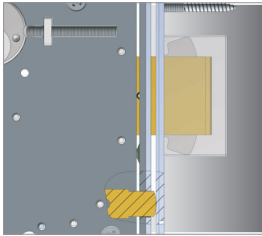

### Self-latching / Self-locking

- Self-latching: When sliding door is closed, deadbolt is automatically engaged into strike. Lever retracts deadbolt to unlatch
- Self-locking: When sliding door is closed, deadbolt is automatically engaged into strike. Outside lever is in locked position, keeping door locked from outside. Key or inside thumbturn unlocks outside lever and unlocks deadbolt
- Inside lever always allows emergency egress



### Actuator

- Extended release button is built onto the faceplate of the lock
- Once door is closed, the release button is activated, which triggers the deadbolt into the strike

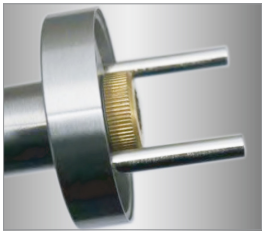

### X Series Trim

- Heavy-duty wire torsion spring
- Cast stainless steel sub-rose with knurled brass nut for mechanical integrity and strength



### ADA Accessibility

- ADA Compliant trim

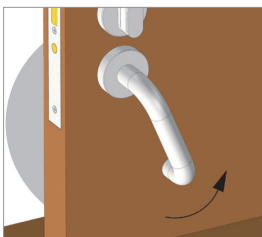

### Emergency Egress

- Single action emergency egress for life safety and code compliance



# PD9600 COMPONENTS AND DIMENSIONS

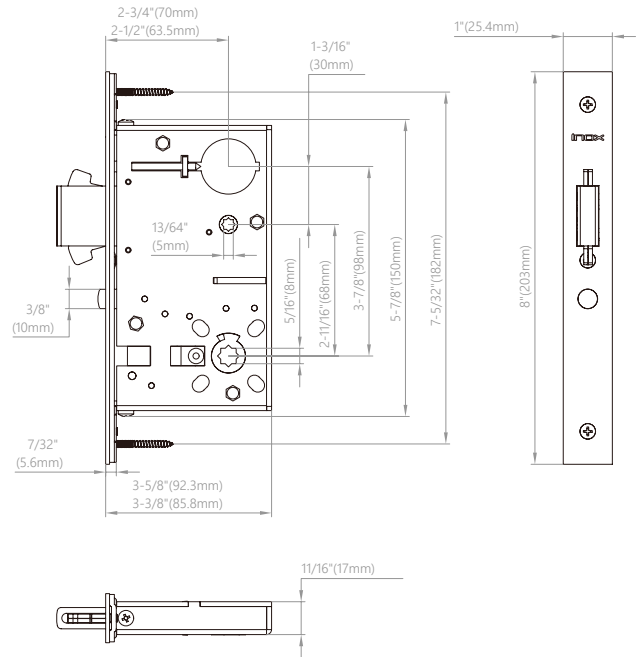
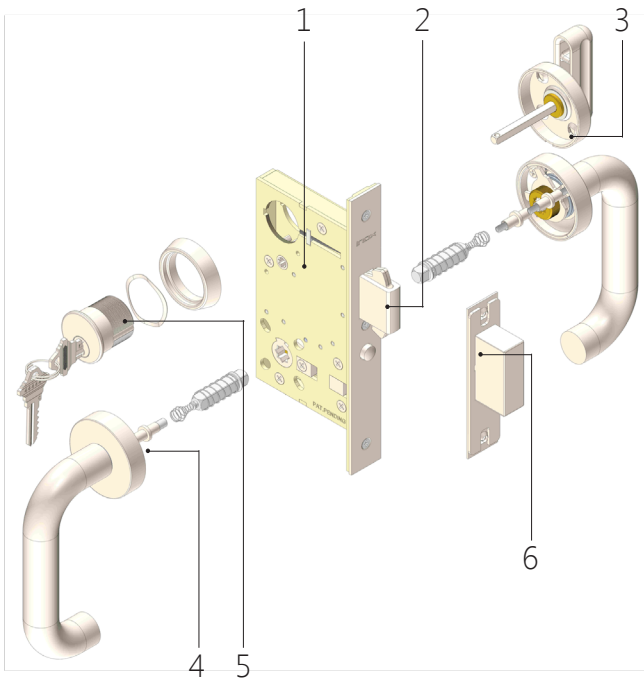

## Description

- 1 Lockcase and faceplate; 2-3/4" backset or 2-1/2" backset
- 2 1" (25.4mm) heavy-duty brass bolt throw with self-retracting non-marring hooks
- 3 ADA Compliant thumbturn
- 4 Heavy-duty Stainless Steel cast rose with choice of X Series lever design
- 5 Schlage C keyway, 6 pin 1-1/4" mortise cylinder
- 6 Adjustable strike for deadbolt; up to 1/4" vertical adjustability (6.35mm)

# PD9600 FUNCTIONS

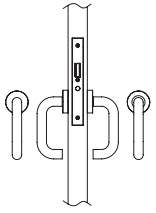

### Passage: PD9610

- Actuator button on faceplate contacts strike and automatically engages deadbolt when sliding door closes
- No thumbturn or keyed cylinder
- Outside and inside levers are active and can retract deadbolt

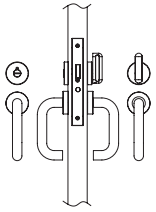

### Privacy: PD9640

- Actuator button on faceplate contacts strike and automatically engages deadbolt when sliding door closes
- Outside lever is rigid when locked and cannot retract deadbolt
- Outside lever can retract deadbolt when unlocked
- Inside thumbturn can lock or unlock outside lever
- Outside coin turn emergency release can also unlock outside lever
- Operating inside lever to retract deadbolt **simultaneously** resets outside lever and inside thumbturn to unlocked position
- Inside lever can always retract deadbolt for emergency egress

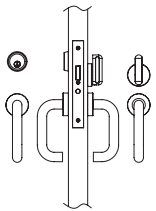

### Inner Entry: PD9650

- Actuator button on faceplate contacts strike and automatically engages deadbolt when sliding door closes
- Outside lever locked or unlocked by key or inside thumbturn
- Outside lever is rigid when locked and cannot retract deadbolt
- Outside lever retracts deadbolt when unlocked
- Operating inside lever for egress **simultaneously** resets outside lever and inside thumbturn to unlocked position
- Inside lever can always retract deadbolt for emergency egress

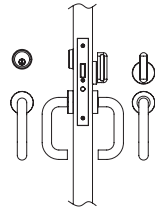

### Entrance: PD9653

- Actuator button on faceplate contacts strike and automatically engages deadbolt when sliding door closes
- Outside lever locked or unlocked by key or inside thumbturn
- Outside lever is rigid when locked and cannot retract deadbolt
- Outside lever retracts deadbolt when unlocked
- Outside lever will remain in locked or unlocked position until user resets status with key or inside thumbturn
- Operating inside lever will **not** change the locked or unlocked status of the outside lever or inside thumbturn
- Inside lever can always retract deadbolt for emergency egress

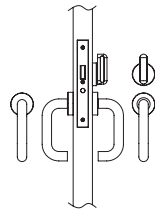

### Patio: PD9660

- Actuator button on faceplate contacts strike and automatically engages deadbolt when sliding door closes
- Outside lever is locked or unlocked by inside thumbturn
- Outside lever is rigid when locked and cannot retract deadbolt
- Outside lever can retract deadbolt when unlocked
- No keyed cylinder outside; door cannot be opened from outside when locked
- Operating inside lever to retract deadbolt **simultaneously** resets outside lever and inside thumbturn to unlocked position
- Inside lever can always retract deadbolt for emergency egress

# PD9600 FUNCTIONS

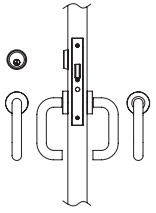

**Classroom: PD9670**

- Actuator button on faceplate contacts strike and automatically engages deadbolt when sliding door closes
- Outside lever is locked or unlocked only by key
- Outside lever is rigid when locked and cannot retract deadbolt
- Outside lever retracts deadbolt when unlocked
- No thumbturn on inside
- Operating inside lever for egress will **not** change the locked or unlocked status of outside lever
- Inside lever can always retract deadbolt for emergency egress

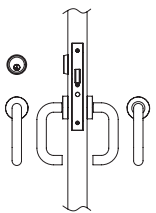

**Storeroom: PD9680**

- Actuator button on faceplate contacts strike and automatically engages deadbolt when sliding door closes
- Outside lever is locked or unlocked only by key
- Outside lever is rigid when locked and cannot retract deadbolt
- Outside lever retracts deadbolt when unlocked
- Key cannot be removed from cylinder when outside lever is unlocked; key can only be removed when outside lever is in locked position. Requires special CAM
- No thumbturn on inside
- Operating inside lever will **not** change locked status of outside lever
- Inside lever can always retract deadbolt for emergency egress

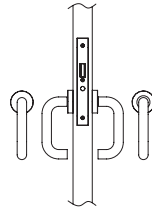

**Exit: PD9690**

- Actuator button on faceplate contacts strike and automatically engages deadbolt when sliding door closes
- Outside lever is always rigid and locked and cannot retract deadbolt
- No cylinder outside, no thumbturn inside
- Inside lever can always retract deadbolt for emergency egress

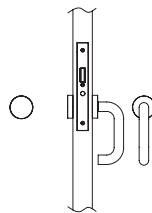

**Communicating: PD9692**

- Actuator button on faceplate contacts strike and automatically engages deadbolt when sliding door closes
- Lever retracts deadbolt
- No lever on opposite side, blank or blind rosette only

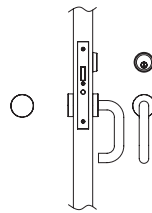

**Security Communicating: PD9695**

- Keyed function for connected rooms with security; only an authorized user may lock/unlock the room-side lever, e.g. hotel staff
- Actuator button on faceplate contacts strike and automatically engages deadbolt when sliding door closes
- Room-side lever is locked or unlocked by key
- Room-side lever can retract deadbolt when unlocked
- Room-side lever is rigid when key locks the lever
- No lever on opposite side; blank or blind rosette only

# PD9500 & PD9600 ROSE AND LEVER DESIGNS

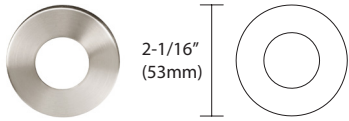

XGT Rose

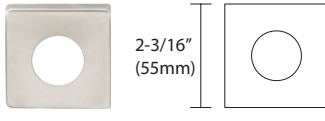

XGS Rose



201 Cologne



202 Munich\*



205 Frankfurt



221 Aurora



243 Sunrise



244 Twilight\*



276 Plaza



318 Café



319 Hampton



320 Empire



321 Valencia\*



345 Tokyo



346 Osaka\*

All levers available in 32, 32D or CeraMax C19G, C19, CGY, or CDB  
PVD4 finish available in the 243, 276, and 321 lever designs

\*Return-to-Door Lever Designs: Complies with California and other state building codes for door openings

# PD9500 & PD9600 THUMBTURN OPTIONS

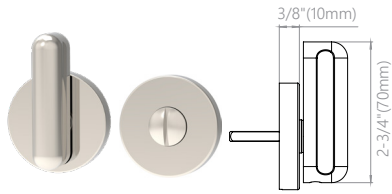

**EC-R530PVS-ADA (GT)**  
TT07 Thumbturn with coin release

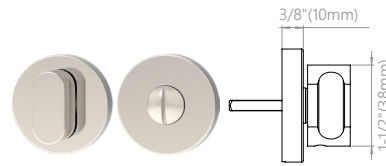

**EC-R530PVS (GT)**  
TT04 Thumbturn with coin release

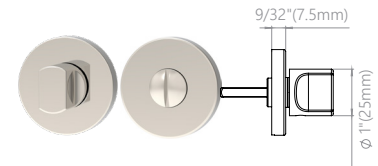

**EC-R530PVS-TT02 (GT)**  
TT02 Thumbturn with coin release

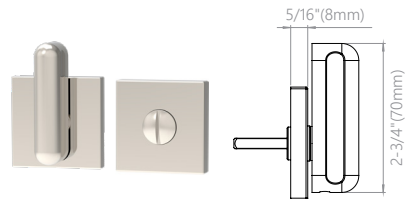

**EC-S530PVS-ADA (GS)**  
TT07 Thumbturn with coin release

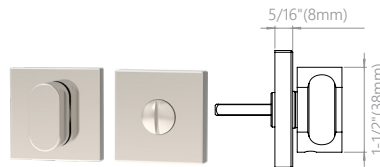

**EC-S530PVS (GS)**  
TT04 Thumbturn with coin release

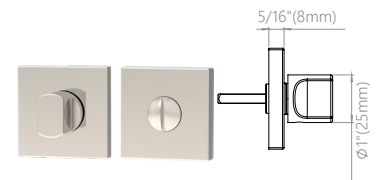

**EC-S530PVS-TT02 (GS)**  
TT02 Thumbturn with coin release

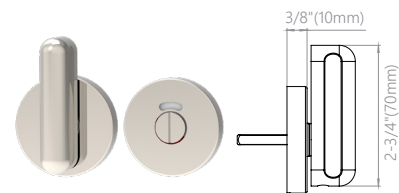

**EC-R530PVSW-ADA (GT)**  
TT07 Thumbturn with coin turn release and indicator

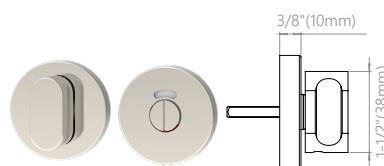

**EC-R530PVSW (GT)**  
TT04 Thumbturn with coin turn release and indicator

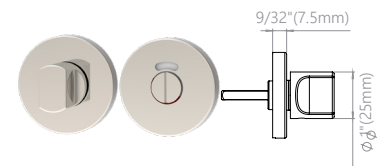

**EC-R530PVSW-TT02 (GT)**  
TT02 Thumbturn with coin turn release and indicator

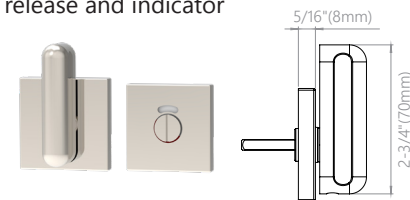

**EC-S530PVSW-ADA (GS)**  
TT07 Thumbturn with coin turn release and indicator

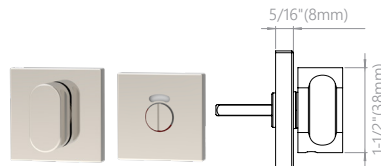

**EC-S530PVSW (GS)**  
TT04 Thumbturn with coin turn release and indicator

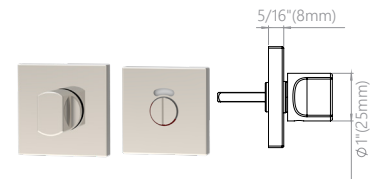

**EC-S530PVSW-TT02 (GS)**  
TT02 Thumbturn with coin turn release and indicator

# PD9600 THUMBTURN OPTIONS



**EC-R560TT07PVSW-ADA (GT)**  
TT07 Thumbturn with coin turn release and indicator

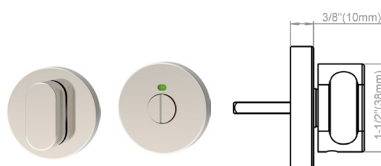

**EC-R560TT04PVSW (GT)**  
TT04 Thumbturn with coin turn release and indicator

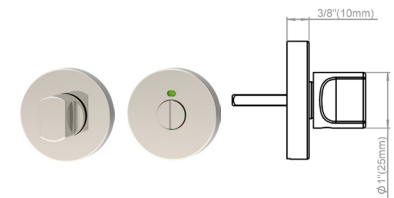

**EC-R560TT02PVSW (GT)**  
TT02 Thumbturn with coin turn release and indicator

## PD9500 FACEPLATE AND STRIKE



**PD-83-FP** (Standard 1" Faceplate)  
**PD-83-FP114** (Optional 1-1/4" Faceplate)

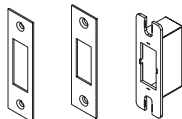

**PD-ADJ-STRK** (Strike and Dustbox Only)

## PD9600 FACEPLATE AND STRIKE



**PD-96-FP** (Standard 1" Faceplate)  
**PD-96-FP114** (Optional 1-1/4" Faceplate)

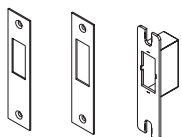

**PD96-ADJ-STRK** (Strike and Dustbox Only)

### SLIDING DOOR HANDING



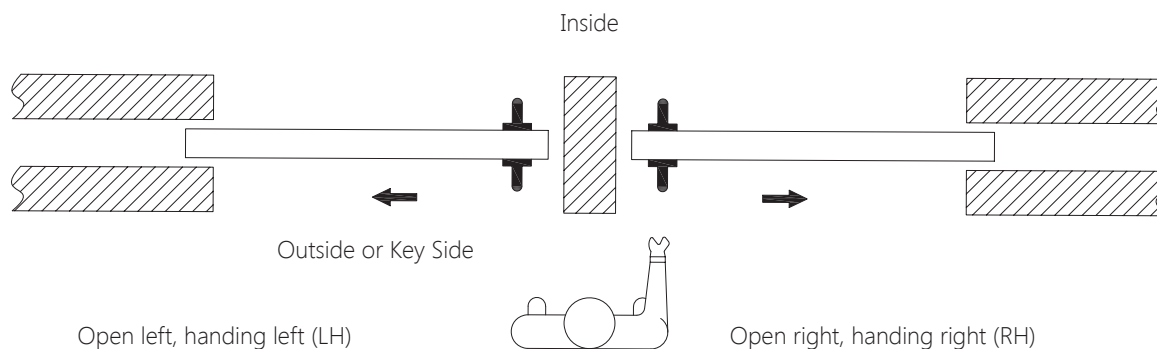













Handing refers to the direction the door slides open. Example: If the door slides to the left to open, it is a left-handed door. Handing is determined from the exterior or key side of the door when facing into the room.



# HOW TO ORDER

## PD9500 Mortise Locks with X Series Levers for Sliding Doors

To order locksets, please describe the additional requirements in the same sequence as below. Please see price book for parts or additional service upcharge.

Rose	Lever	Lock	Function	Backset	Cylinder	Thumbturn	Indicator	Finish	Handing
<b>XGS</b> <b>1</b>	<b>201</b> <b>2</b>	<b>-PD95</b> <b>3</b>	<b>50</b> <b>4</b>	<b>A</b> <b>5</b>		<b>-GS07</b> <b>7</b>	<b>8</b>	<b>-32D</b> <b>9</b>	<b>-LH</b> <b>10</b>
<b>ROSE</b>	<b>LEVER</b>	<b>LOCK</b>	<b>FUNCTION</b>						
 XGT	 201	 -PD95	 50						
 XGS	 202		 205	 221	 243				
	 244		 276	 318	 319				
	 321		 345	 346					
			<b>5 BACKSET</b>						
			Backset Blank = 2-3/4"						
			Backset A = 2-1/2"						

### 6 CYLINDER AND HOUSING (includes collar)

LC = Less Cylinder



Blank = Standard Mortise 1-1/4" Cylinder



-S6 = Small Format Interchangeable Cylinder (SFIC) Housing 1-1/4", 6-Pin, Less Core, L Clover Cam

-S7 = Small Format Interchangeable Cylinder (SFIC) Housing 1-3/8", 7-Pin, Less Core, L Clover Cam

-L6 = Large Format Interchangeable Cylinder (LFIC) Housing 1-1/2", 6-Pin, Less Core, L Clover Cam



Order IC Cores and Thick Door Kits (TDKs) separately

### 7 THUMBTURN



GT02



GT04



Blank = GT07



GS02



GS04



GS07

### 8 INDICATOR

Blank = Without Indicator

-W = With Indicator

### 9 FINISH

Standard:



-32D



-C19G



-C19



-CGY



-CDB



-32



-PVD4

PVD4 finish available in the 243, 276, and 321 lever designs

### 10 HANDING

-RH = Right Hand

-LH = Left Hand

# HOW TO ORDER

## PD9600 Mortise Locks with X Series Levers for Sliding Doors

To order locksets, please describe the additional requirements in the same sequence as below. Please see price book for parts or additional service upcharge.

Rose	Lever	Lock	Function	Backset	Cylinder	Thumbturn	Indicator	Finish	Handing
<b>XGT</b>	<b>243</b>	<b>-PD96</b>	<b>53</b>	<b>A</b>	<b>-S6</b>	<b>-GT4</b>	<b>-W</b>	<b>-32D</b>	<b>-LH</b>
<b>1</b>	<b>2</b>	<b>3</b>	<b>4</b>	<b>5</b>	<b>6</b>	<b>7</b>	<b>8</b>	<b>9</b>	<b>10</b>

### ROSE



### LEVER

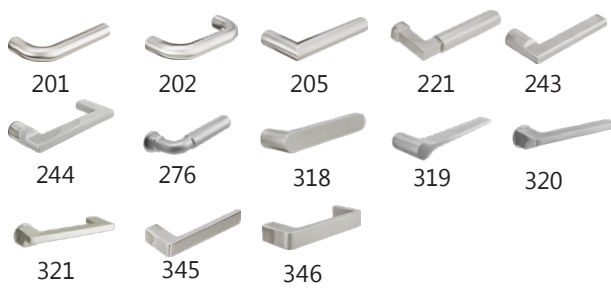

### LOCK

-PD96

### FUNCTION

- 10 Passage
- 40 Privacy
- 50 Inner Entry
- 53 Entrance
- 60 Patio
- 70 Classroom
- 80 Storeroom
- 90 Exit
- 92 Communicating
- 95 Security Communicating

### 5 BACKSET

Backset Blank = 2-3/4"

Backset A = 2-1/2"

### 6 CYLINDER AND HOUSING (includes collar)

LC = Less Cylinder



Blank = Standard Mortise 1-1/4" Cylinder



-S6 = Small Format Interchangeable Cylinder (SFIC) Housing 1-1/4", 6-Pin, Less Core, L Clover Cam

-S7 = Small Format Interchangeable Cylinder (SFIC) Housing 1-3/8", 7-Pin, Less Core, L Clover Cam

-L6 = Large Format Interchangeable Cylinder (LFIC) Housing 1-1/2", 6-Pin, Less Core, L Clover Cam



Order IC Cores and Thick Door Kits (TDKs) separately

### 7 THUMBTURN



### 8 INDICATOR

Blank = Without Indicator

-W = With Indicator

### 9 FINISH

Standard:



-32D



-C19G



-C19



-CGY



-CDB



-32



-PVD4

PVD4 finish available in the 243, 276, and 321 lever designs

### 10 HANDING

-RH = Right Hand

-LH = Left Hand



# PD3000 NARROW PROFILE ICU LOCK

For Sliding Doors



## SPECIFICATIONS

<b>Door Thickness</b>	1-3/4" (45mm) Thick Door Kits available
<b>Backset</b>	1-1/4" (31.5mm)
<b>Lever Spindle</b>	8mm x 8mm square
<b>Case Size</b>	4-1/2" x 5/8" x 1-19/32" (114mm x 16mm x 40.5mm)
<b>Handing</b>	Non-Handed

<b>Material</b>	Narrow Escutcheon: Zinc Alloy Lever: Stainless Steel Lockcase: Stainless Steel Hook Bolt: Stainless Steel Faceplate/Strike: Stainless Steel
-----------------	---

## FEATURES

- Narrow-profile mortise lock fits door openings where larger mortise locks cannot, including glass doors
- Stainless steel bolt, hub, and faceplate integrated in an innovative design with activator that provides self-latching function
- Designed to replace existing narrow profile locks; INOX retrofit is easy and provides improved strength, resilience, and durability
- Successfully tested to 250,000 cycles for lever and self-latching Hook Bolt

## FUNCTION

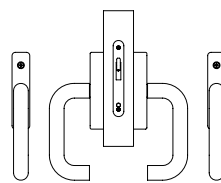

### Passage: PD3010

- Self-latching: When sliding door is closed, Hook Bolt is automatically engaged into strike
- Outside and inside levers are always unlocked and retract the Hook Bolt

## STANDARD FINISHES

- 32D Satin Stainless Steel
- 19G Graphite Black
- CeraMax Ceramic Coating: C19G Graphite Black, C19 Flat Black, CGY Stormy Grey, CDB Dark Bronze

*For additional finish options not listed, contact Sales Department for MOQ and lead times*

# PD3000 COMPONENTS AND DIMENSIONS

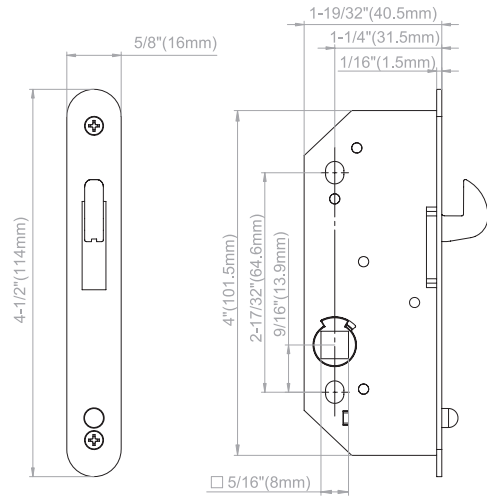
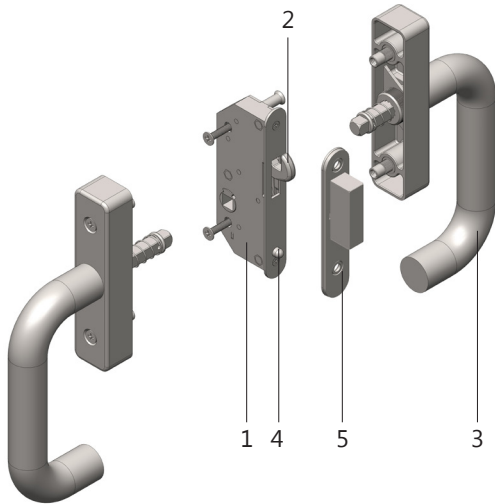

## DESCRIPTION

1. PD3000 lockcase
2. Self-Latching Hook Bolt
3. Narrow Escutcheon (NE) with 502 Munich lever
4. Actuator button to activate the retracted Self-Latching Hook Bolt
5. Strike

## ESCUTCHEON DIMENSIONS

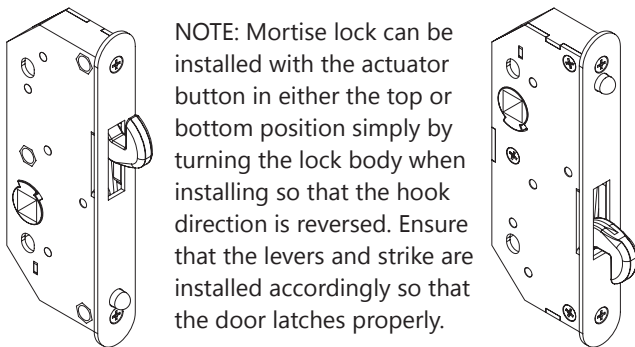
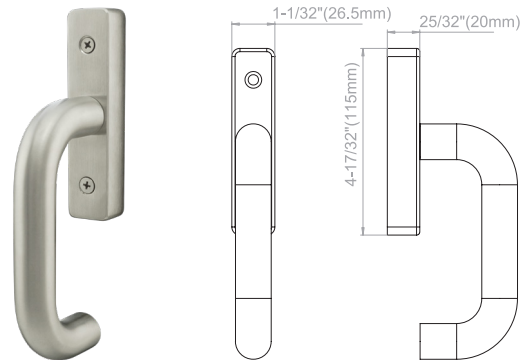

NOTE: Mortise lock can be installed with the actuator button in either the top or bottom position simply by turning the lock body when installing so that the hook direction is reversed. Ensure that the levers and strike are installed accordingly so that the door latches properly.

## HOW TO ORDER

Specify the Escutcheon, Lever, Lock, Function, and Finish using the product identification below:

Standard Product Identifications

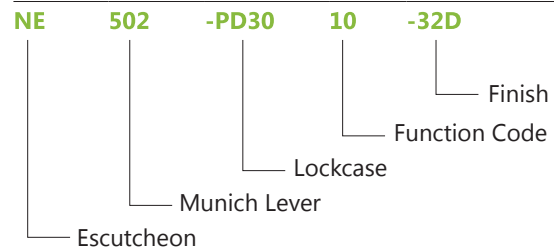

# PD8000 & PD5000 MORTISE LOCKS

with Surface Pulls for Sliding Doors



PD8000 with PHIX41714 ADA Pull



PD8000 with PHIX330.512.8 ADA Pull



PD5000 with PHIX45714 ADA Pull



PD5000 with PHIX31108 ADA Pull

# PD8000 MORTISE LOCK

for Sliding or Pocket Doors



## SPECIFICATIONS

<b>Door Thickness</b>	1-3/4" (45mm) Standard Thick Door Kits available
<b>Thin Pocket Door Options</b>	1-3/8" (35mm) use FH17, FH27SL, FH22CF, or FH23CF flush pull options
<b>Handing</b>	Non-Handed
<b>Thumbturn Spindle</b>	5mm x 5mm square
<b>Deadbolt</b>	1" (25.4mm) for 2-3/4" or 2-1/2" backset 3/4" (19mm) for 2" backset
<b>Cylinder</b>	Schlage C keyway 5 pin mortise cylinder with 2 keys (KD). Keying Services available, order separately
<b>Lockcase</b>	Heavy Gauge Steel
<b>Deadbolt and Edge Pull</b>	Brass and Stainless Steel

## FEATURES

- Unique improvements not found in standard mortise locks, including patented gravity-powered wing bolts that work much more quietly than standard bolts
- Designer flush pulls and ADA compliant surface pulls in a wide array of beautiful finishes that accent and complement any decor
- Stainless Steel construction for maximum durability and longevity

## STANDARD FINISHES

- Surface Pull standard finishes, please see pages 55-57
- Flush Pull standard finishes, please see page 41

*For additional finish options not listed, contact Sales Department for MOQ and lead times*

# PD8000 MORTISE COMPONENTS AND DIMENSIONS

## for Sliding or Pocket Doors

### PD84: Lockcase with Deadbolt and Edge Pull

Available in 3 backsets: 2", 2-1/2", and 2-3/4"

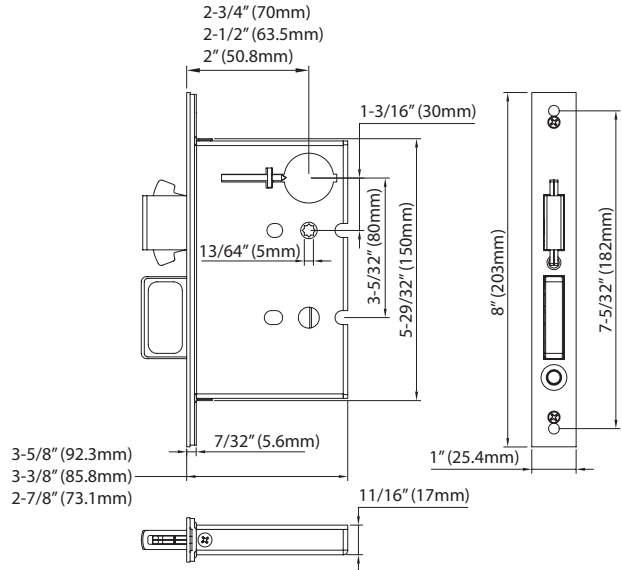
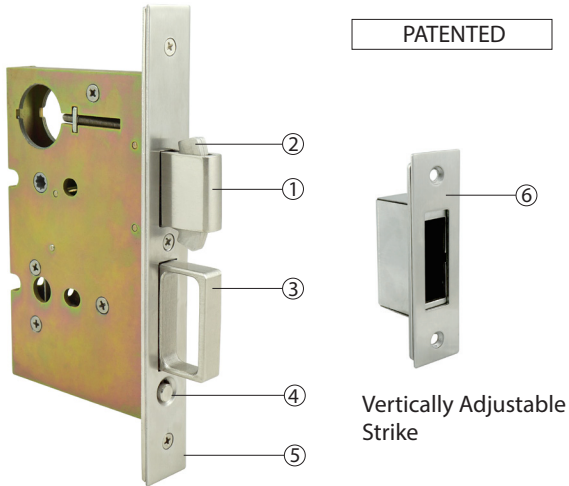

1. Brass deadbolt with 1" throw for 2-3/4" or 2-1/2" backset and 3/4" throw for 2" backset
2. Self-retracting hook with non-marring latch bolt
3. Spring-loaded edge pull with unique internal sound buffer
4. Solid brass push button
5. Stainless steel faceplate, 2mm thick
6. Vertically adjustable strike (shown)

### LOCK OPTIONS



- PD80** (2-3/4" Backset)  
**PD80A** (2-1/2" Backset)  
**PD80B** (2" Backset)
- Lockcase with Edge Pull for pocket door
  - No Deadbolt
  - No Deadbolt or Cylinder



- PD81** (2-3/4" Backset)  
**PD81A** (2-1/2" Backset)  
**PD81B** (2" Backset)
- Lockcase with built-in Edge Pull and Dust Proof Strike for inactive pair pocket door



- PD82** (2-3/4" Backset)  
**PD82A** (2-1/2" Backset)  
**PD82B** (2" Backset)
- Lockcase with built-in Dust Proof Strike for an inactive pair sliding door
  - No Edge Pull



- PD83** (2-3/4" Backset)  
**PD83A** (2-1/2" Backset)  
**PD83B** (2" Backset)
- Lockcase with Deadbolt for sliding door
  - No Edge Pull
  - Less Cylinder



- PD84** (2-3/4" Backset)  
**PD84A** (2-1/2" Backset)  
**PD84B** (2" Backset)
- Lockcase with Deadbolt and Edge Pull for pocket door

# PD8000 FUNCTIONS

## Sliding Door

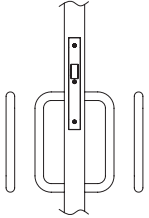

**PD8215**  
**Passage with Lockcase as Dust Proof Strike**  
 • Lockcase used as dust proof strike on pair of doors, inactive side

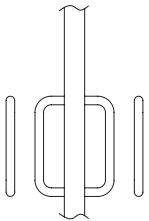

**BTB**  
**Dummy/Passage without Lock Case**

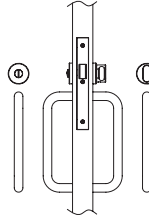

**PD8340**  
**Privacy with Emergency Release**  
 • Deadbolt operated by inside thumbturn or outside emergency release coin turn

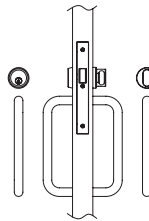

**PD8350**  
**Entry with Single Cylinder**  
 • Key outside or thumbturn inside retracts deadbolt

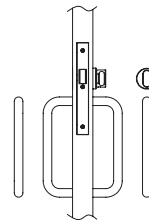

**PD8360**  
**Patio**  
 • Deadbolt operated by thumbturn from inside only

## Pocket Door

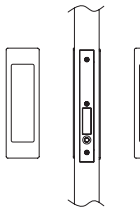

**PD8010**  
**Passage with Lockcase**  
 • Used as flush pull or matching trim on pairs of doors  
 • Edge finger pull operated by push button

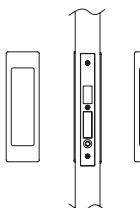

**PD8115**  
**Passage with Lockcase as Dust Proof Strike**  
 • Lockcase used as dust proof strike on pair of doors, inactive side  
 • Edge finger pull operated by push button

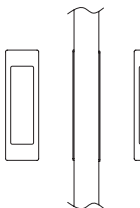

**DP**  
**Dummy/Passage without Lock Case**  
 • No Edge pull

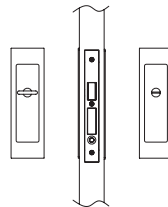

**PD8440**  
**Privacy with Emergency Release**  
 • Deadbolt operated by inside thumbturn or outside emergency release coin turn  
 • Edge finger pull operated by push button

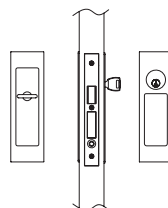

**PD8450**  
**Entry with Single Cylinder**  
 • Key outside or thumbturn inside retracts deadbolt  
 • Edge finger pull operated by push button

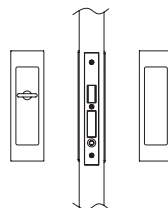

**PD8460**  
**Patio**  
 • Deadbolt operated by thumbturn from inside only  
 • Edge finger pull operated by push button

# PD5000 MORTISE LOCK

for Sliding or Pocket Doors



## SPECIFICATIONS

<b>Door Thickness</b>	1-3/4" (45mm) Standard Thick Door Kits available
<b>Thin Pocket Door Options</b>	1-3/8" (35mm) use FH17, FH27SL, FH22CF, or FH23CF flush pull options
<b>Handing</b>	Non-Handed
<b>Thumbturn Spindle</b>	5mm x 5mm square
<b>Deadbolt</b>	1" (25.4mm) for 2-3/4" or 2-1/2" backset 3/4" (19mm) for 2" backset
<b>Cylinder</b>	Schlage C keyway 5 pin mortise cylinder with 2 keys (KD) Keying Services available; order separately
<b>Lockcase</b>	Heavy Gauge Steel
<b>Deadbolt &amp; Edge Pull</b>	Brass and Stainless Steel
<b>Faceplate &amp; Strike</b>	Stainless Steel

## FEATURES

- Provides new possibilities for sliding door locks, with a variety of residential and commercial applications
- Constructed of heavy gauge steel and coupled with beautiful designer flush and surface pull options
- Array of beautiful, long-lasting finishes including ceramic coating options for aesthetic perfection

## STANDARD FINISHES

- Surface Pull standard finishes, please see pages 55-57
- Flush Pull standard finishes, please see page 42

*For additional finish options not listed, contact Sales Department for MOQ and lead times*

# PD5000 COMPONENTS AND DIMENSIONS

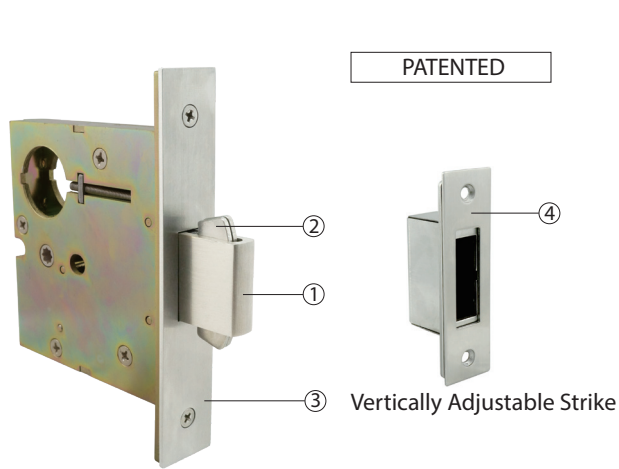

- 1) Brass deadbolt with 1" throw for 2-3/4" or 2-1/2" backset and 3/4" throw for 2" backset
- 2) Self-retracting hook with non-marring latch bolt
- 3) Stainless steel faceplate, 2mm thick
- 4) Vertically adjustable strike

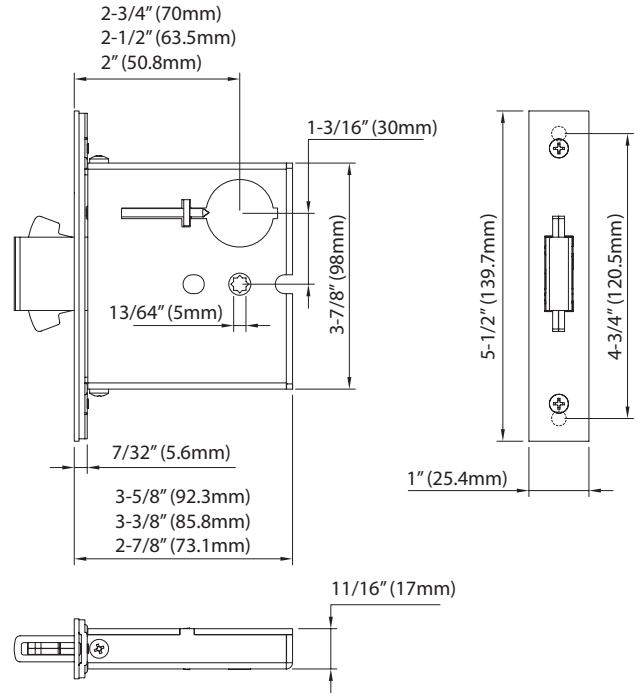

## LOCK OPTIONS



- |  |   |  |
|--|---|--|
| <p><b>PD50</b> (2-1/2" / 2-3/4" Backset)</p> <p><b>PD50B</b> (2" Backset)</p> <ul style="list-style-type: none"> <li>• Lock Case with Edge Pull</li> </ul> | <p><b>PD52</b> (2-1/2" / 2-3/4" Backset)</p> <p><b>PD52B</b> (2" Backset)</p> <ul style="list-style-type: none"> <li>• Lockcase with built-in Dust Proof Strike for inactive pair of sliding doors</li> <li>• No Edge Pull</li> </ul> | <p><b>PD53</b> (2-3/4" Backset)</p> <p><b>PD53A</b> (2-1/2" Backset)</p> <p><b>PD53B</b> (2" Backset)</p> <ul style="list-style-type: none"> <li>• Lockcase with Deadbolt</li> <li>• No Edge Pull</li> </ul> |
|--|---|--|



# PD5000 FUNCTIONS

## Sliding Door

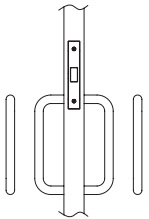

**PD5215**  
**Passage with Lockcase as Dust Proof Strike**  
 • Lockcase used as dust proof strike on pair of sliding doors, inactive side

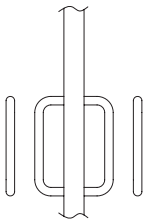

**BTB**  
**Dummy/Passage without Lock Case**

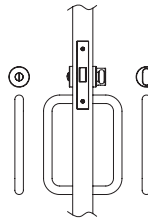

**PD5340**  
**Privacy with Emergency Release**  
 • Deadbolt operated by inside thumbturn or outside emergency release coin turn

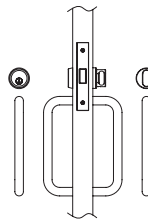

**PD5350**  
**Entry with Single Cylinder**  
 • Key outside or Thumbturn inside retracts deadbolt

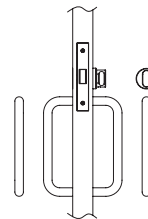

**PD5360**  
**Patio**  
 • Deadbolt operated by Thumbturn from inside only

## Pocket Door

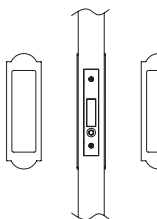

**PD5010**  
**Passage with Lockcase**  
 • Used as flush pull or matching trim on pairs of pocket doors  
 • Edge finger pull operated by push button

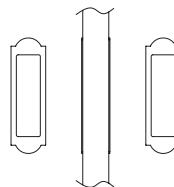

**DP**  
**Dummy/Passage without Lock Case**  
 • No Edge pull

# PD5000 & PD8000 THUMBTURN ROUND OPTIONS

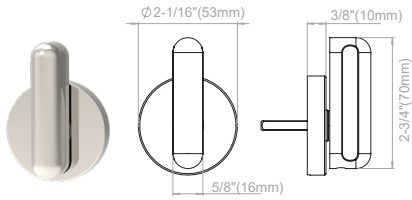

GT07

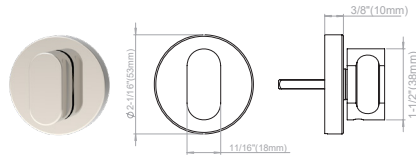

GT04

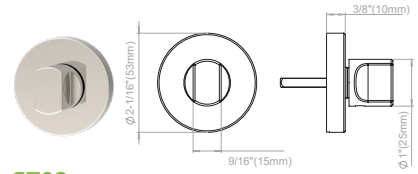

GT02

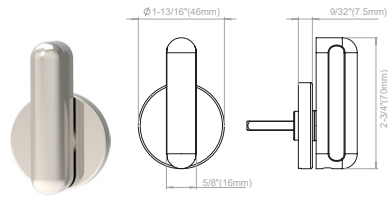

GR07

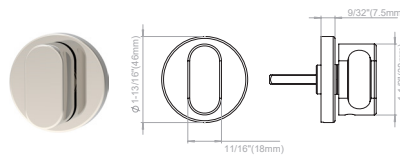

GR04

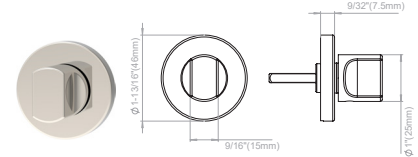

GR02

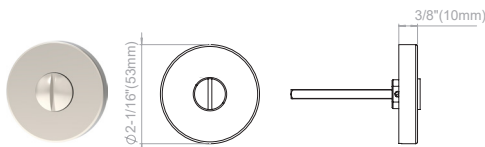

GT Coin Turn Release

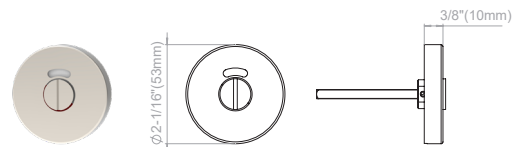

GT Coin Turn Release and Indicator

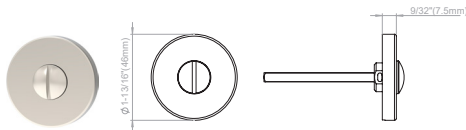

GR Coin Turn Release

# PD5000 & PD8000 THUMBTURN SQUARE OPTIONS

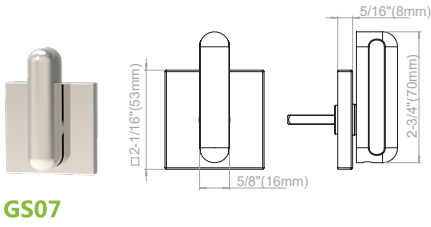

GS07

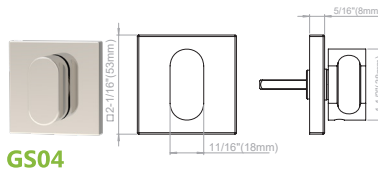

GS04

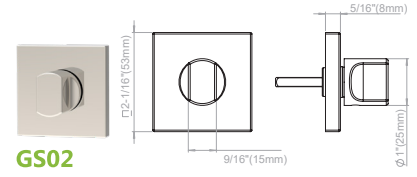

GS02

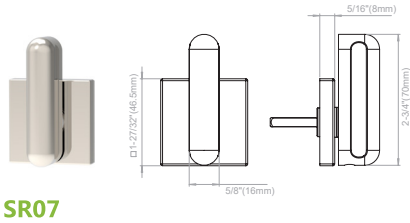

SR07

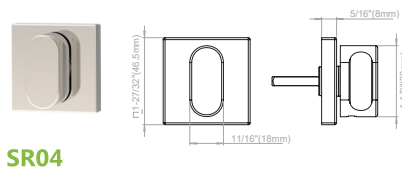

SR04

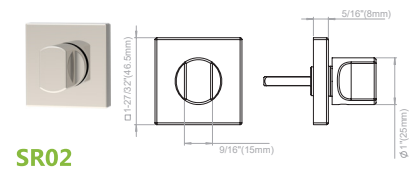

SR02

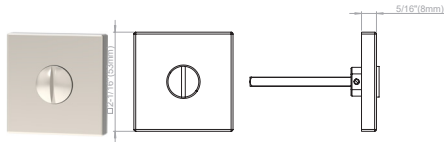

GS Coin Turn Release

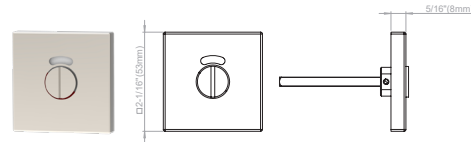

GS Coin Turn Release and Indicator

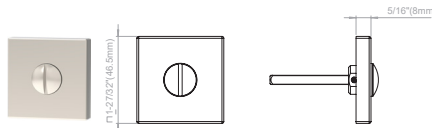

SR Coin Turn Release

# PD8000, PD5000 MORTISE LOCKS & PD2000 TWISTLOCK with Flush Pulls for Pocket Doors



PD8000 with FH27 Linear Flush Pull



PD8000 with FH31 Regal Flush Pull



PD5000 with FH22 Luna Flush Pull



PD2000 TwistLock™ Edge-Pull Privacy Lock

# FH17 BEZEL FLUSH PULL

PD8000/PD5000 for Sliding or Pocket Doors



## SPECIFICATIONS

<b>Standard Door Thickness</b>	1-3/8" to 1-3/4" (35mm to 45mm) Thick Door Kits available
<b>Backset</b>	2-3/4" (70mm), 2-1/2" (63.5mm) and 2" (50.8mm)
<b>Handing</b>	Non-Handed
<b>Thumbturn Spindle</b>	5x5mm square
<b>Deadbolt</b>	1" (25.4mm) for 2-3/4" or 2-1/2" backset 3/4" (19mm) for 2" backset
<b>Cylinder</b>	Schlage C keyway 5 pin mortise cylinder with 2 keys (KD). Keying services available; order separately
<b>Material</b>	Stainless Steel/Brass

## DIMENSIONS

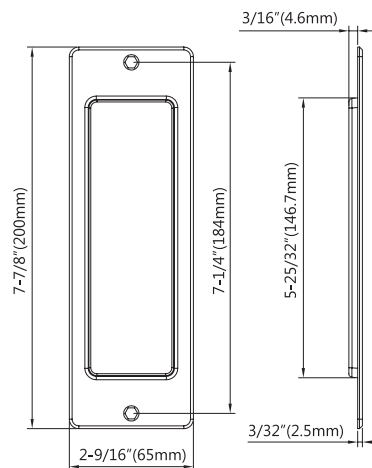

## TRIM OPTIONS



**FH1700**  
Flush Pull Only



**FH1792**  
Flush Pull with TT09  
Thumbturn



**FH1704**  
Flush Pull with  
Thumbturn Release



**FH1703**  
Flush Pull with  
Cylinder Hole

# FH27 / FH27SL LINEAR FLUSH PULL

PD8000/PD5000 for Sliding or Pocket Doors



## SPECIFICATIONS

<b>Standard Door Thickness</b>	1-3/4" (45mm) Thick Door Kits available
<b>Backset</b>	2-3/4" (70mm), 2-1/2" (63.5mm) and 2" (50.8mm)
<b>Slim Trim</b>	Slim Trim (FH27SL) available for 1-3/8" (35mm) doors
<b>Handing</b>	Non-Handed
<b>Thumbturn Spindle</b>	5x5mm square
<b>Deadbolt</b>	1" (25.4mm) for 2-3/4" or 2-1/2" backset 3/4" (19mm) for 2" backset
<b>Cylinder</b>	Schlage C keyway 5 pin mortise cylinder with 2 keys (KD). Keying services available; order separately
<b>Material</b>	Stainless Steel/Brass

## DIMENSIONS

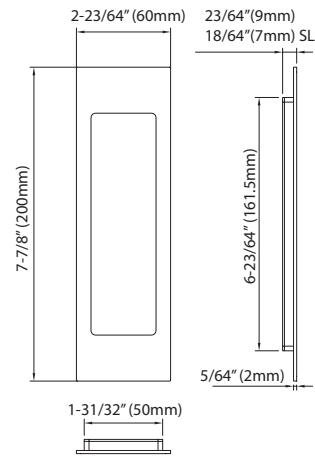

## TRIM OPTIONS



**FH2700 FH2700SL**  
Flush Pull Only



**FH2792 FH2792SL**  
Flush Pull with TT09  
Thumbturn



**FH2704 FH2704SL**  
Flush Pull with  
Thumbturn Release



**FH2703\***  
Flush Pull with  
Cylinder Hole

**FH2782\***  
Flush Pull with  
TT08 Thumbturn

\* Not available with SL

# FH29 ARC FLUSH PULL

PD8000/PD5000 for Sliding or Pocket Doors



## SPECIFICATIONS

<b>Standard Door Thickness</b>	1-3/4" (45mm) Thick Door Kits available
<b>Backset</b>	2-3/4" (70mm), 2-1/2" (63.5mm) and 2" (50.8mm)
<b>Handing</b>	Non-Handed
<b>Thumbturn Spindle</b>	5x5mm square
<b>Deadbolt</b>	1" (25.4mm) for 2-3/4" or 2-1/2" backset 3/4" (19mm) for 2" backset
<b>Cylinder</b>	Schlage C keyway 5 pin mortise cylinder with 2 keys (KD). Keying services available; order separately
<b>Material</b>	Stainless Steel/Brass

## DIMENSIONS

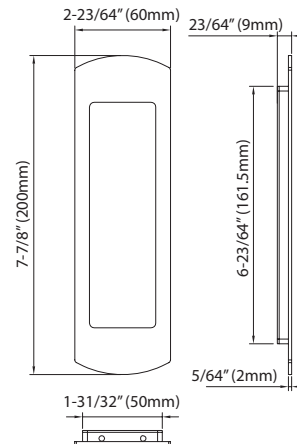

## TRIM OPTIONS



**FH2900**  
Flush Pull Only



**FH2992**  
Flush Pull with TT09  
Thumbturn



**FH2904**  
Flush Pull with  
Thumbturn Release



**FH2903**  
Flush Pull with  
Cylinder Hole



**FH2982**  
Flush Pull with  
TT08 Thumbturn

# FH31 REGAL FLUSH PULL

PD8000/PD5000 for Sliding or Pocket Doors



## SPECIFICATIONS

<b>Standard Door Thickness</b>	1-3/4" (45mm) Thick Door Kits available
<b>Backset</b>	2-3/4" (70mm), 2-1/2" (63.5mm) and 2" (50.8mm)
<b>Handing</b>	Non-Handed
<b>Thumbturn Spindle</b>	5x5mm square
<b>Deadbolt</b>	1" (25.4mm) for 2-3/4" or 2-1/2" backset 3/4" (19mm) for 2" backset
<b>Cylinder</b>	Schlage C keyway 5 pin mortise cylinder with 2 keys (KD). Keying services available; order separately
<b>Material</b>	Stainless Steel/Brass

## DIMENSIONS

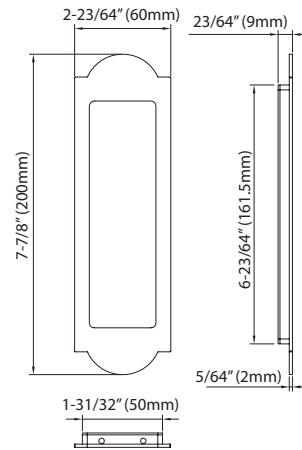

## TRIM OPTIONS



**FH3100**  
Flush Pull Only



**FH3103**  
Flush Pull  
with Cylinder Hole



**FH3182**  
Flush Pull with  
TT08 Thumbturn



**FH3192**  
Flush Pull with  
TT09 Thumbturn



**FH3104**  
Flush Pull with  
Thumbturn Release



# FH32 CROWN FLUSH PULL

PD8000/PD5000 for Sliding or Pocket Doors



## SPECIFICATIONS

<b>Standard Door Thickness</b>	1-3/4" (45mm) Thick Door Kits available
<b>Backset</b>	2-3/4" (70mm), 2-1/2" (63.5mm) and 2" (50.8mm)
<b>Handing</b>	Non-Handed
<b>Thumbturn Spindle</b>	5x5mm square
<b>Deadbolt</b>	1" (25.4mm) for 2-3/4" or 2-1/2" backset 3/4" (19mm) for 2" backset
<b>Cylinder</b>	Schlage C keyway 5 pin mortise cylinder with 2 keys (KD). Keying services available; order separately
<b>Material</b>	Stainless Steel/Brass

## DIMENSIONS

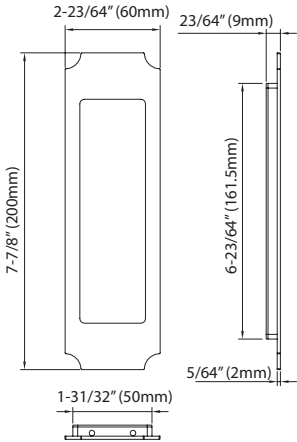

## TRIM OPTIONS



**FH3200**  
Flush Pull Only



**FH3203**  
Flush Pull  
with Cylinder Hole



**FH3282**  
Flush Pull with  
TT08 Thumbturn



**FH3292**  
Flush Pull with  
TT09 Thumbturn



**FH3204**  
Flush Pull with  
Thumbturn Release

# FH22 LUNA FLUSH PULL

PD8000/PD5000 for Sliding or Pocket Doors



## SPECIFICATIONS

<b>Standard Door Thickness</b>	1-3/4" (45mm) Thick Door Kits available
<b>Backset</b>	2-3/4" (70mm), 2-1/2" (63.5mm) and 2" (50.8mm)
<b>Handing</b>	Non-Handed
<b>Thumbturn Spindle</b>	5x5mm square
<b>Deadbolt</b>	1" (25.4mm) for 2-3/4" or 2-1/2" backset 3/4" (19mm) for 2" backset
<b>Cylinder</b>	Schlage C keyway 5 pin mortise cylinder with 2 keys (KD). Keying services available; order separately
<b>Material</b>	Stainless Steel/Brass

## DIMENSIONS

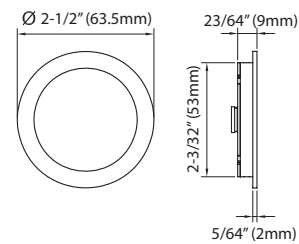

## TRIM OPTIONS



**FH2200**  
Flush Pull Only



**FH2204**  
Flush Pull with  
Thumbturn Release



**FH2203\***  
Flush Pull with  
Cylinder Hole

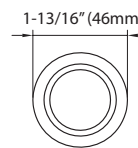

**FH2282\***  
Flush Pull with  
TT08 Thumbturn

\* Not available with CF

# FH22CF LUNA CONCEALED FIXING FLUSH PULL

PD8000/PD5000 for 1-3/8" or thicker Sliding or Pocket Doors



### SPECIFICATIONS

<b>Standard Door Thickness</b>	1-3/8" (35mm) & 1-3/4" (45mm) Thick Door Kits available
<b>Backset</b>	2-3/4" (70mm), 2-1/2" (63.5mm) and 2" (50.8mm)
<b>Handing</b>	Non-Handed
<b>Thumbturn Spindle</b>	5x5mm square
<b>Deadbolt</b>	1" (25.4mm) for 2-3/4" or 2-1/2" backset 3/4" (19mm) for 2" backset
<b>Material</b>	Stainless Steel

### DIMENSIONS

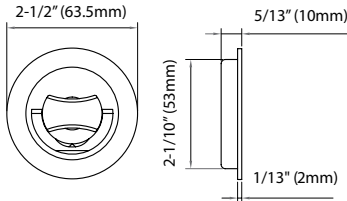

### TRIM OPTIONS



**FH2200CF**  
Flush Pull Only



**FH2204CF**  
Flush Pull with  
Thumbturn Release



**FH2262CF**  
Flush Pull with  
TT06 Thumbturn

# FH23 URBAN FLUSH PULL

PD8000/PD5000 for Sliding or Pocket Doors



## SPECIFICATIONS

<b>Standard Door Thickness</b>	1-3/4" (45mm) Thick Door Kits available
<b>Backset</b>	2-3/4" (70mm), 2-1/2" (63.5mm) and 2" (50.8mm)
<b>Handing</b>	Non-Handed
<b>Thumbturn Spindle</b>	5x5mm square
<b>Deadbolt</b>	1" (25.4mm) for 2-3/4" or 2-1/2" backset 3/4" (19mm) for 2" backset
<b>Cylinder</b>	Schlage C keyway 5 pin mortise cylinder with 2 keys (KD). Keying services available; order separately
<b>Material</b>	Stainless Steel/Brass

## DIMENSIONS

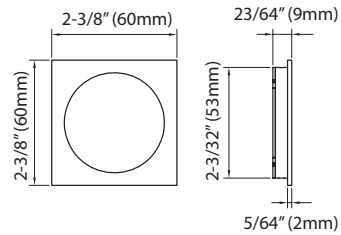

## TRIM OPTIONS



**FH3200**  
Flush Pull Only



**FH3204**  
Flush Pull with  
Thumbturn Release



**FH3203\***  
Flush Pull with  
Cylinder Hole

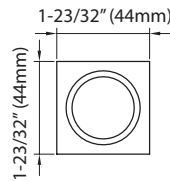

**FH3282\***  
Flush Pull with  
TT08 Thumbturn

\* Not available with CF

# FH23CF URBAN CONCEALED FIXING FLUSH PULLS

PD8000/PD5000 for 1-3/8" or thicker Sliding or Pocket Doors



## SPECIFICATIONS

<b>Standard Door Thickness</b>	1-3/8" (35mm) & 1-3/4" (45mm) Thick Door Kits available
<b>Backset</b>	2-3/4" (70mm), 2-1/2" (63.5mm) and 2" (50.8mm)
<b>Handing</b>	Non-Handed
<b>Thumbturn Spindle</b>	5x5mm square
<b>Deadbolt</b>	1" (25.4mm) for 2-3/4" or 2-1/2" backset 3/4" (19mm) for 2" backset
<b>Material</b>	Stainless Steel

## DIMENSIONS

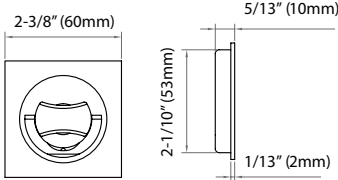

## TRIM OPTIONS



**FH2300**  
Flush Pull Only



**FH2362CF**  
Flush Pull with  
Thumbturn



**FH2304CF**  
Flush Pull with  
Thumbturn Release

# PD2000 TWISTLOCK EDGE PULL PRIVACY LOCK

## Locking Edge Pull for Pocket Doors



### SPECIFICATIONS

<b>Door Thickness</b>	Standard Trim: 1-3/8" (35mm) to 1-3/4" (45mm) Concealed Fastener Trim: 1-3/4" (45mm) Thick door kit available, please contact the sales department
<b>Backset</b>	2-3/8" (60mm)
<b>Bolt Projection</b>	5/8" (15.5mm)
<b>Thumbturn Spindle</b>	5 x 5mm square
<b>Handing</b>	Non-Handed

### STANDARD FINISHES

- 32D Satin Stainless Steel
- 19G Graphite Black
- CeraMax Ceramic Coating: C19G Graphite Black, C19 Flat Black, CGY Stormy Grey, CDB Dark Bronze

*For additional finish options not listed, contact Sales Department for MOQ and lead times*

### FEATURES

- Privacy pocket door lock with edge pull combination
- Utilizes a unique rotating bolt to lock into the strike
- Edge pull operates a 2-in-1 spring-loaded pull and locking bolt
- Designed to fit in standard 2-1/8" bore
- Commercially tested with 200,000 cycle test
- User-friendly emergency coin release from the outside

### FUNCTION

**Privacy Lock with Edge Pull: PD2062**

- Spring-loaded edge pull activated by pressing on front end. Once edge pull is inserted into strike, rotate thumbturn on recessed trim to rotate pull inside strike, transforming it into a deadbolt.
- Unlock by turning thumbturn back, or via emergency coin release on outside of door. Push deadbolt/edge pull back into lockcase when not in use.

**Passage/Edge Pull: PD2061**

- Spring-loaded edge pull is activated by pressing on front end.
- Recessed flush trim assists closing and opening of door.

# PD2000 TWISTLOCK EDGE PULL PRIVACY LOCK

## Locking Edge Pull for Pocket Doors

### PD2000 COMPONENTS

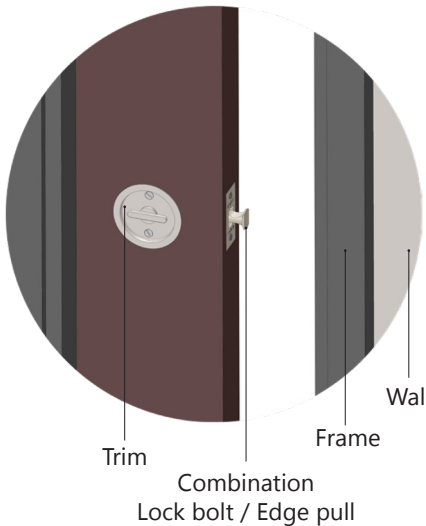
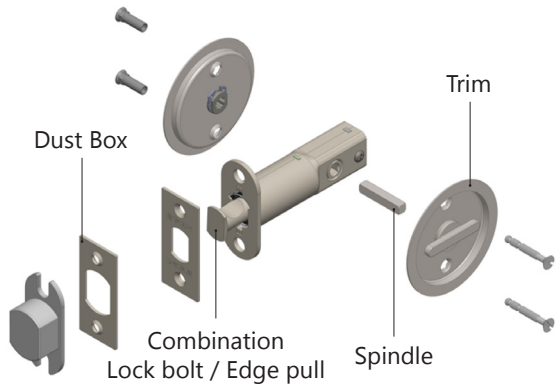

### STANDARD TRIM

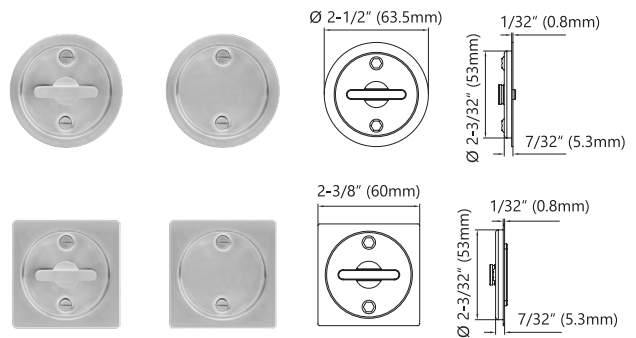

Item Codes	Trim	Thumbturn	Backset	Lock/Function
<b>FH12 PD2061</b>	FH12	TT08	2-3/8"	Passage
<b>FH12 PD2062</b>	FH12	TT08	2-3/8"	Privacy
<b>FH13 PD2061</b>	FH13	TT08	2-3/8"	Passage
<b>FH13 PD2062</b>	FH13	TT08	2-3/8"	Privacy

### STANDARD TRIM

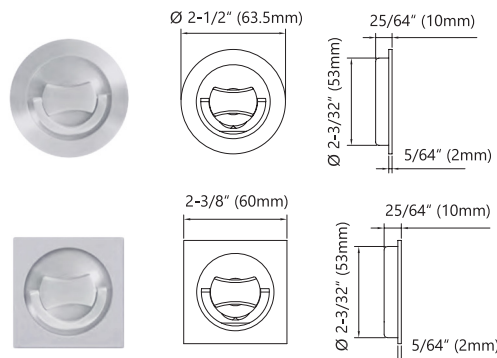

### PD2000 Lock

Lock case only:  
PD2060 2-3/8" Backset

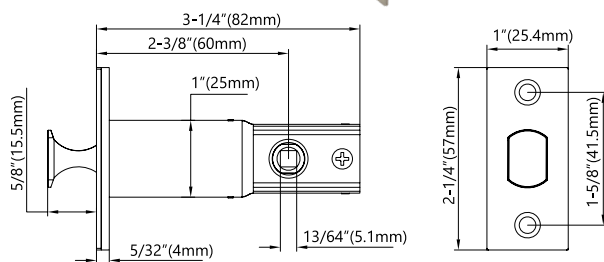

Item Codes	Trim	Thumbturn	Backset	Lock/Function
<b>FH22CF PD2061</b>	FH22CF	TT06	2-3/8"	Passage
<b>FH22CF PD2062</b>	FH22CF	TT06	2-3/8"	Privacy
<b>FH23CF PD2061</b>	FH23CF	TT06	2-3/8"	Passage
<b>FH23CF PD2062</b>	FH23CF	TT06	2-3/8"	Privacy

## PD8000/PD5000 FACEPLATE AND STRIKE



- PD-84-FP** (Standard 1" Faceplate)
- PD-84-FP114** (Optional 1-1/4" Faceplate)
- Lockcase with Deadbolt and Edge Pull: Entry, Privacy, Patio



- PD-80-FP** (Standard 1" Faceplate)
- PD-80-FP114** (Optional 1-1/4" Faceplate)
- Lockcase with Edge Pull, No Deadbolt: Passage



- PD-83-FP** (Standard 1" Faceplate)
- PD-83-FP114** (Optional 1-1/4" Faceplate)
- Lockcase with Deadbolt, No Edge Pull: Entry, Privacy, Patio



- PD-81-FP** (Standard 1" Faceplate)
- PD-81-FP114** (Optional 1-1/4" Faceplate)
- Lockcase with Build-in Edge Pull: Passage Inactive



- PD-82-FP** (Standard 1" Faceplate)
- PD-82-FP114** (Optional 1-1/4" Faceplate)
- Lockcase with Built-in Dust Proof Strike: Passage Inactive



- PD-53-FP** (Standard 1" Faceplate)
- PD-53-FP114** (Optional 1-1/4" Faceplate)
- Lockcase with Deadbolt: Entry, Privacy, Patio



- PD-50-FP** (Standard 1" Faceplate)
- PD-50-FP114** (Optional 1-1/4" Faceplate)
- Lockcase with Edge Pull: Passage



- PD-52-FP** (Standard 1" Faceplate)
- PD-52-FP114** (Optional 1-1/4" Faceplate)
- Lockcase with Built-in Dust Proof Strike: Passage Inactive



# HOW TO ORDER

## PD8000 Mortise Locks for Sliding Doors

To order, please describe the additional requirements in the same sequence as below. Please see Price Book for additional parts or service upcharges.

Function	Backset	Cylinder	Thumbturn	Indicator	Finish
<b>PD8350</b>	<b>A</b>	<b>-S6</b>	<b>-GR02</b>		<b>-32D</b>
<b>1</b>	<b>2</b>	<b>3</b>	<b>4</b>	<b>5</b>	<b>6</b>

### FUNCTION

- 8010 Passage
- 8215 Passage with dust-proof strike
- 8340 Privacy
- 8350 Entry
- 8360 Patio

*PD8215 passage function is not compatible with thumbturn and cylinder*

To order PD8000 Mortise Locks with Surface Pulls for sliding doors, order lockcase [backset / cylinder / thumbturn].

Surface Pull will need to be ordered as a separate line item, either bolt-thru single pull or back-to-back double pulls.

Example: **PHIX30108-BTB-32D**  
**PD8350A-S6-GR04-32D**

### 2 BACKSET

Backset Blank = 2-3/4"

Backset A = 2-1/2"

Backset B = 2"

### 3 CYLINDER AND HOUSING (includes collar)

LC = Less Cylinder



Blank = Standard Mortise 1-1/4" Cylinder



-S6 = Small Format Interchangeable Cylinder (SFIC) Housing 1-1/4", 6-Pin, Less Core, L Clover Cam

-S7 = Small Format Interchangeable Cylinder (SFIC) Housing 1-3/8", 7-Pin, Less Core, L Clover Cam

-L6 = Large Format Interchangeable Cylinder (LFIC) Housing 1-1/2", 6-Pin, Less Core, L Clover Cam



Order IC Cores and Thick Door Kits (TDKs) separately

### 4 THUMBTURN



GR02  
GT02  
GS02  
SR02



GR04  
GT04  
GS04  
SR04



Blank = GR07  
GT07  
GS07  
SR07

See page 24 and 25 for detailed thumbturn option designs

### 5 INDICATOR

Blank = Without Indicator

-W = With Indicator

Only GT and GS rosettes are compatible with thumbturn indicator

### 6 FINISH

Standard:



-32D



-C19G



-C19



-CGY



-CBD



-32



-PVD4



19G

PVD4 finish available for PHIX330.512.8 Surface Pull

Special Order Finishes subject to minimum order quantity, extended lead-time and upcharge. Contact Sales Department for details.

# HOW TO ORDER

## PD5000 Mortise Locks for Sliding Doors

To order, please describe the additional requirements in the same sequence as below. Please see price book for parts or additional service upcharge.

Function	Backset	Cylinder	Thumbturn	Indicator	Finish
<b>PD5340</b>	<b>A</b>	<b>-S6</b>	<b>-GT04</b>		<b>-32D</b>
<b>1</b>	<b>2</b>	<b>3</b>	<b>4</b>	<b>5</b>	<b>6</b>

### FUNCTION

- 5010 Passage
- 5215 Passage with Dust-proof Strike
- 5340 Privacy
- 5350 Entry
- 5360 Patio

To order the PD5000 Mortise Locks with Surface Pulls for sliding doors, order lockcase [backset /cylinder / thumbturn].  
Surface Pull will need to be ordered as a separate line item, either bolt-thru single pull or back-to-back double pulls.

Example: **PD5340A-S6-GT04-32D**  
**PHIX330.512.8-BTB-32D**

### 2 BACKSET

Backset Blank = 2-3/4"

Backset A = 2-1/2"

Backset B = 2"

### 3 CYLINDER AND HOUSING

LC = Less Cylinder



Blank = Standard Mortise 1-1/4" Cylinder



- S6 = Small Format Interchangeable Cylinder (SFIC) Housing 1-1/4", 6-Pin, Less Core, L Clover Cam
- S7 = Small Format Interchangeable Cylinder (SFIC) Housing 1-3/8", 7-Pin, Less Core, L Clover Cam
- L6 = Large Format Interchangeable Cylinder (LFIC) Housing 1-1/2", 6-Pin, Less Core, L Clover Cam



Order IC Cores and Thick Door Kits (TDKs) separately

### 4 THUMBTURN



- GR02
- GT02
- GS02
- SR02



- GR04
- GT04
- GS04
- SR04



- Blank = GR07
- GT07
- GS07
- SR07

See page 24 and 25 for detailed thumbturn option designs

### 5 INDICATOR

- Blank = Without Indicator
- W = With Indicator

Only GT and GS rosettes are compatible with thumbturn indicator

### 6 FINISH

Standard:



-32D



-C19G



-C19



-CGY



-CDB



-32



-PVD4



19G

PVD4 finish available for PHIX330.512.8 Surface Pull

Special Order Finishes subject to minimum order quantity, extended lead-time and upcharge. Contact Sales Department for details.

# HOW TO ORDER

## PD8000 Mortise Locks with Flush Pulls for Pocket Doors

To order, please describe the additional requirements in the same sequence as below. Please see Price Book for additional parts or service upcharges.

Flush Pull	Function	Backset	Thumbturn	Finish
<b>FH27</b> <b>1</b>	<b>PD8450</b> <b>2</b>	<b>A</b> <b>3</b>	<b>4</b>	<b>-32D</b> <b>5</b>

**FLUSH PULL**

FH17 FH27 FH27SL FH29 FH31 FH32  
FH22 FH23 FH22CF FH23CF

**FUNCTION**

8010 Passage  
8115 Passage with dust-proof strike  
8440 Privacy  
8450 Entry  
8460 Patio

NOTE: PD8115 and PD8450 Locks are not suitable for FH22CF and FH23CF Trim, PD8450 is not suitable for FH27SL

### 3 BACKSET

Backset Blank = 2-3/4"

Backset A = 2-1/2"

Backset B = 2"

### 4 THUMBTURN

Blank = Privacy with TT08

(FH22 and FH23 are only available with TT08,  
FH22CF and FH23CF feature a unique TT06 turn  
and are not available with TT08 or TT09)

TT09= Privacy with TT09

(FH17, FH27SL are only available with TT09)

### 5 FINISH

	FH17	FH27	FH27SL	FH29	FH31	FH32	FH22	FH23	FH22CF	FH23CF
Standard -32D	✓	✓	✓	✓	✓	✓	✓	✓	✓	✓
-32	✓	✓	✓	✓	✓	✓	✓	✓	✓	✓
-10B	✓	✓	✓	✓	✓	✓	✓	✓	✓	✓
-4	✓	✓	✓	✓	✓	✓	✓	✓	✓	✓
-19G	✓	✓	✓						✓	✓
-15		✓	✓	✓	✓	✓	✓		✓	
-26D		✓	✓	✓	✓	✓	✓	✓	✓	✓
-26		✓	✓				✓			
-38		✓	✓	✓	✓	✓	✓	✓	✓	✓
-14		✓	✓	✓	✓	✓	✓			
-3							✓	✓		

Special Order Finishes subject to minimum order quantity, extended lead-time and upcharge. Contact Sales Department for details.

# HOW TO ORDER

## PD5000 Mortise Locks with Flush Pulls for Pocket Doors

To order, please describe the additional requirements in the same sequence as below. Please see price book for parts or additional service upcharge.

Flush Pull	Function	Backset	Thumbturn	Finish
<b>FH27</b> <b>1</b>	<b>PD5440</b> <b>2</b>	<b>B</b> <b>3</b>	<b>4</b>	<b>-32D</b> <b>5</b>
<b>FLUSH PULL</b>			<b>FUNCTION</b>	
			5010 Passage 5215 Passage with Dust-proof Strike 5340 Privacy 5350 Entry 5360 Patio	

NOTE: PD5010 Lock is not suitable for FH22CF and FH23CF Trim, PD5350 is not suitable for FH27SL Trim

### 3 BACKSET

Backset Blank = 2-3/4"

Backset A = 2-1/2"

Backset B = 2"

### 4 THUMBTURN

Blank = Privacy with TT08

(FH22 and FH23 are only available with TT08,  
 FH22CF and FH23CF feature a unique TT06 turn  
 and are not available with TT08 or TT09)

TT09= Privacy with TT09

(FH17, FH27SL are only available with TT09)

### 5 FINISH

	FH17	FH27	FH27SL	FH29	FH31	FH32	FH22	FH23	FH22CF	FH23CF
Standard -32D	√	√	√	√	√	√	√	√	√	√
-32	√	√	√	√	√	√	√	√	√	√
-10B	√	√	√	√	√	√	√	√	√	√
-4	√	√	√	√	√	√	√	√	√	√
-19G	√	√	√						√	√
-15		√	√	√	√	√	√		√	
-26D		√	√	√	√	√	√	√	√	√
-26		√	√				√			
-38		√	√	√	√	√	√	√	√	√
-14		√	√	√	√	√	√			
-3							√	√		

Special Order Finishes subject to minimum order quantity, extended lead-time and upcharge.  
 Contact Sales Department for details.



# BD4000 & BD1000 BARN DOOR LOCKS

for Residential, Hospitality and Multi-Family Applications



**BD4000**

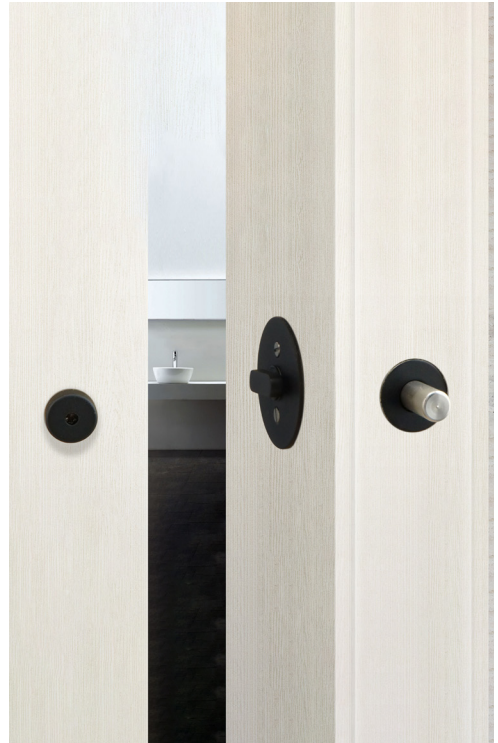

**BD4000**



**BD1000**

# BD4000 CONCEALED JAMB MOUNT

## Barn Door Privacy Lock



### SPECIFICATIONS

<b>Material</b>	Trim: Stainless Steel Lockcase: Steel Lockbolt: Stainless Steel Strike: Stainless Steel
<b>Lock Bolt</b>	1/2" (13mm) Diameter
<b>Drive-in Bolt Casing</b>	1" (25mm) Diameter Strike mounted in Barn Door for standard door thickness: 1-3/8" (35mm) to 1-3/4" (45mm) Thick Door Kits Available
<b>Backset</b>	2-1/4" (57mm) and 3-1/2" (89mm)
<b>Handing</b>	Non-handed
<b>Hub and Spindle</b>	5mm x 5mm square

### FEATURES

- Innovative engineering places lock inside jamb and dust-proof strike inside door (reverse of typical door locks)
- No need to build out extra frames
- Can retrofit into existing jambs and doors
- Discrete release key provided for emergency opening
- Eight trim options, including ADA compliant thumbturn
- Surpassed ANSI 156.36 grade 3 cycle testing

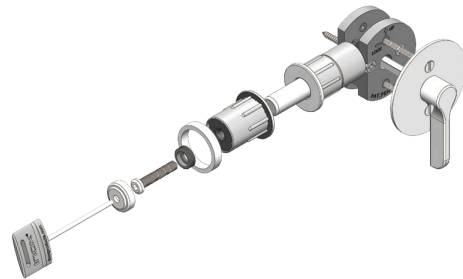

### STANDARD FINISHES

- 32D Satin Stainless Steel
- 32 Bright Stainless Steel
- 10B Oil Rubbed Bronze
- 4 Satin Brass
- 19G Graphite Black
- 26D Satin Chrome
- CeraMax Ceramic Coating: C19G Graphite Black, C19 Flat Black, CGY Stormy Grey, CDB Dark Bronze

*For additional finish options not listed, contact Sales Department for MOQ and lead times*

# BD4000 CONCEALED JAMB MOUNT

## Barn Door Privacy Lock

### WALL THICKNESS

Wall Thickness: 4"~6-1/2"  
Lock: BD4214  
Backset: 2-1/4"

Wall Thickness: 6-1/2" & Up  
Lock: BD4312  
Backset: 3-1/2"

### APPLICATION

- A simple and elegant privacy lock for barn door openings for either residential or commercial applications, without having to build out extra frames
- Tubular drive-in bolt installed inside the jamb
- Dust-proof strike installed in the door
- Discreet release button with decorative cap installed on outside of the door for emergency release
- A variety of trim escutcheon and thumbturn options installed on jamb side to allow locking and unlocking of bolt from inside
- ADA thumbturn available, perfect for commercial and hospitality applications

### OVERLAP

Door Overlap is the distance from the edge of the door to the edge of the wall. Measure the Door Overlap on the lock side when the door is fully closed.  
NOTE: Standard door opening walls have 2 wood studs behind drywall or trim casing

### WALL THICKNESS

1-1/4" (32mm)

1-3/8" (35mm)  
1-3/4" (45mm)  
1" (26mm)

- 1-1/4" (32mm) diameter spring-loaded dust-proof strike provides ample space to receive 1/2" (13mm) bolt and allows easy locking by end user
- Minimum aesthetic impact on door surface
- Strike can be adjusted to fit barn door thickness from 1-3/8" (35mm) to 1-3/4" (45mm)
- Thick Door Kits (TDK) available

1-3/8"~1-3/4"

Labels: Strike, Emergency Release Key, Surface Pull, Door, Lock, Flush Pull, Trim, Jamb, Wall.

Labels: Drywall, Max 1/2", Overlap\*, Min 2", Door.



# BD4000 FLUSH TRIM

## Barn Door Privacy Lock



### FEATURES

- Designed for maximum aesthetics without visible screws or fasteners
- Two beautiful contemporary designs
- Smooth stainless steel thumbturn sits flush against the jamb when not in use
- Not ADA compliant

### SPACER RING

Lock bolt has 1" projection, allows up to 1/2" door to wall gap. Extra spacer ring accommodates up to 3/4" gap between barn door and wall.

### OPTIONAL FACE PLATE

Protects wall from possible damage  
INOX Laser Art designs available  
Order **BD-FPC**



### STANDARD FINISHES

- 32D Satin Stainless Steel
- 32 Bright Stainless Steel
- 10B Oil Rubbed Bronze
- 4 Satin Brass
- 19G Graphite Black
- 26D Satin Chrome
- CeraMax Ceramic Coating: C19G Graphite Black, C19 Flat Black, CGY Stormy Grey, CDB Dark Bronze

*For additional finish options not listed, contact Sales Department for MOQ and lead times*

### THICK DOOR KIT FOR DOORS 2" AND UP

Available for doors up to 3" thick  
Includes extended screw and extended release  
For thicker doors, please contact an INOX sales representative

Door Thickness:  
2" (51.8mm) ~ 3" (76.2mm)

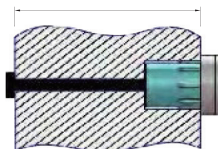

# BD4000 CONCEALED JAMB MOUNT FOR METAL STUDS

## Barn Door Privacy Lock



### FEATURES

- Engineered for walls with metal studs oriented opposite of each other
- Reinforcement bracket strengthens lockbolt
- Unique design allows flexible lock placement in wall

### ORIENTATION OF METAL STUDS

- A. Overlapping - flat surface toward jamb
- B. Overlapping - flat surface away from jamb
- C. Studs back to back
- D. Studs form box (special bracket needed)

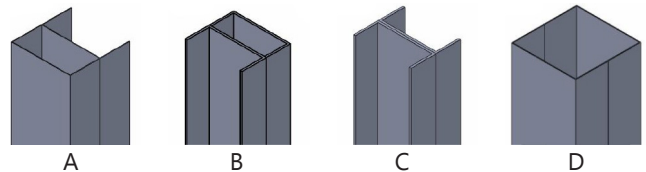

### INSTALLATION OPTIONS

A:

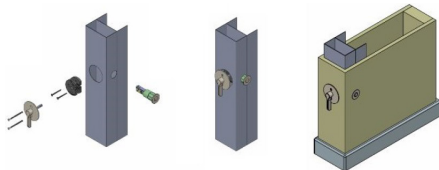

A. (above) requires a 2-1/8" bore through first stud to allow installation on second stud. For B. and C. (below), install bracket on first stud.

B:

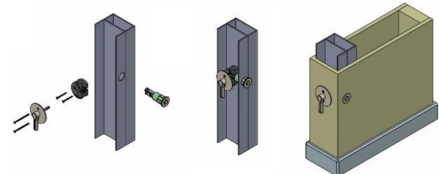

C:

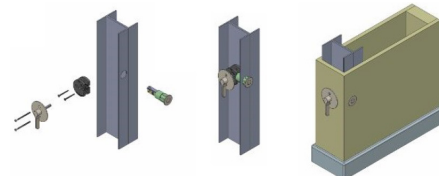

D:

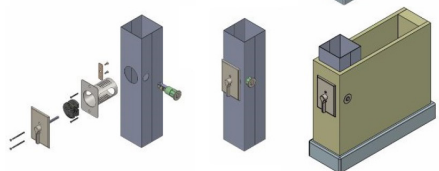

D. (above) requires a special bracket that is only compatible with the rectangular trim shown. This prep requires a 2-1/4" bore on the first stud to allow bracket installation.

Standard bracket for installations A, B, and C, shown with EC1217 Rose and Thumbturn

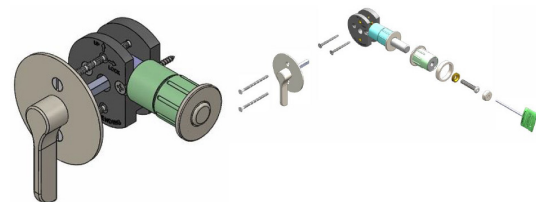

Special bracket, faceplate, and exploded diagram of lock for installation D, shown with TT17 Thumbturn

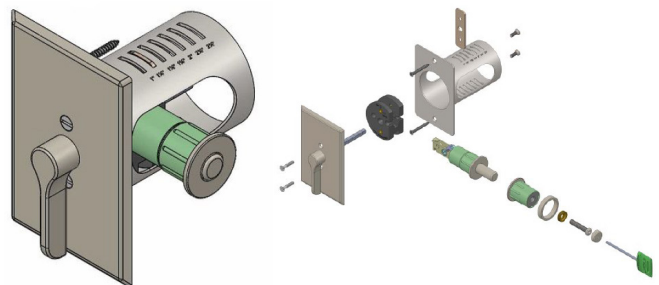

# BD4000 PRIVACY LOCK TRIM OPTIONS

## ESCUTCHEONS & THUMBTURNS

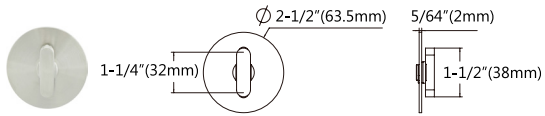

EC1216

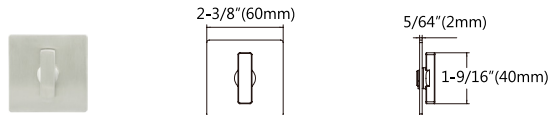

EC1314

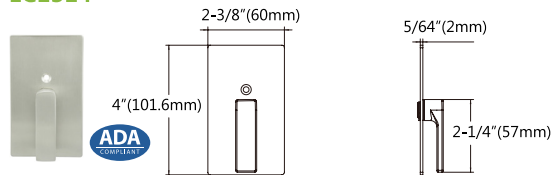

EC1515

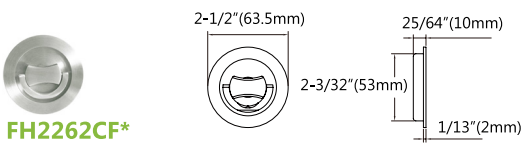

FH2262CF\*

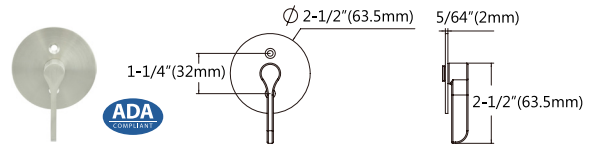

EC1217

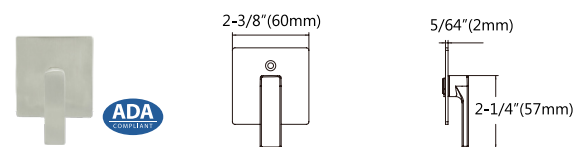

EC1315

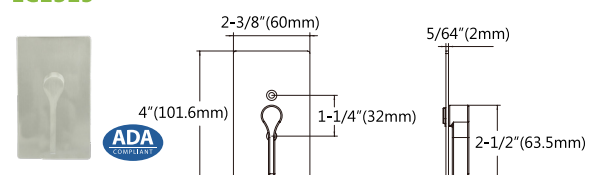

EC1517

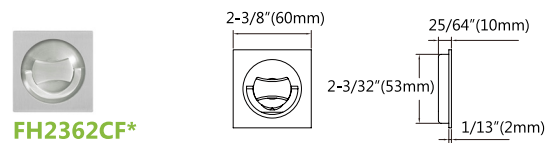

FH2362CF\*

## ESCUTCHEONS & THUMBTURNS FOR METAL STUD

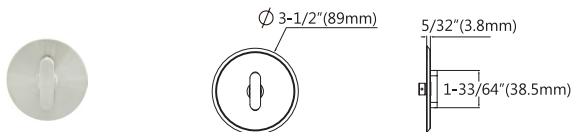

EC3216

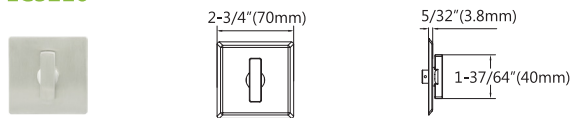

EC3314

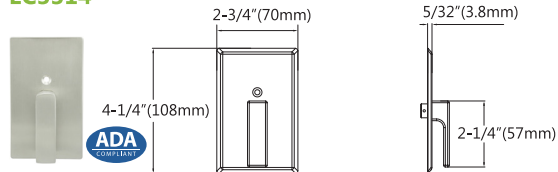

EC3515

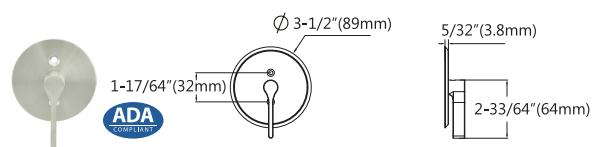

EC3217

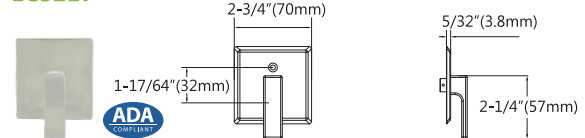

EC3315

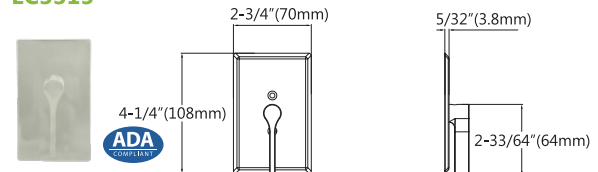









EC3517

\* CF stands for Concealed Fixing

# HOW TO ORDER

## PD4000 Privacy Lock for Barn Door

To order, please describe the additional requirements in the same sequence as below. Please see price book for parts or additional service upcharge.

Rose/Thumbturn	Backset	Option	Finish
<b>EC1315</b> <b>1</b>	<b>BD4214</b> <b>2</b>	<b>MS</b> <b>3</b>	<b>-32D</b> <b>4</b>
<b>ROSE/THUMBTURN</b>			
			
			
<b>EC1216</b> <b>EC3216*</b>	<b>EC1217</b> <b>EC3217*</b>	<b>EC1314</b> <b>EC3314*</b>	<b>EC1315</b> <b>EC3315*</b>
		<b>EC1515</b> <b>EC3515*</b>	<b>EC1517</b> <b>EC3517*</b>
			<b>FH22CF</b> <b>FH23CF</b>

\* for Metal Stud

### 2 BACKSET







BD4214 = 2-1/4"      BD4312 = 3-1/2"

### 3 OPTION

MS Metal Stud

*NOTE: Metal Stud (MS) only applies to structure D*

### 4 FINISH

		EC1216	EC1217	EC1314	EC1315	EC1515	EC1517	FH22CF	FH23CF
Standard	-32D		√	√	√	√	√	√	√
	-32		√	√	√	√	√	√	√
	-10B		√	√	√	√	√	√	√
	-4		√	√	√	√	√	√	√
	-19G		√	√	√	√	√	√	√
	-26D		√	√	√	√	√	√	√

*Special Order Finishes subject to minimum order quantity, extended lead-time and upcharge. Contact Sales Department for details.*

# BD1000 SURFACE MOUNT

## Barn Door Privacy Lock



### SPECIFICATIONS

<b>Material</b>	Stainless Steel
<b>Lockcase</b>	3-9/16" x 1-7/8" x 9/16"
<b>Standard Thumb-lever</b>	13/16" (20mm) (order BD1022)
<b>ADA Thumb-lever</b>	1-9/16" (order BD1023)

### FEATURES

- Installs on any type of wall or jamb casing
- Easy, quick installation—field reversible
- No need to drill drywall or studs; protects decorative molding
- Perfect for renovation or remodeling
- Two thumb levers available, including ADA option



**BD1022**  
Standard 13/16"  
Thumb lever



**BD1023**  
ADA 1-9/16"  
Thumb lever

### DIMENSIONS

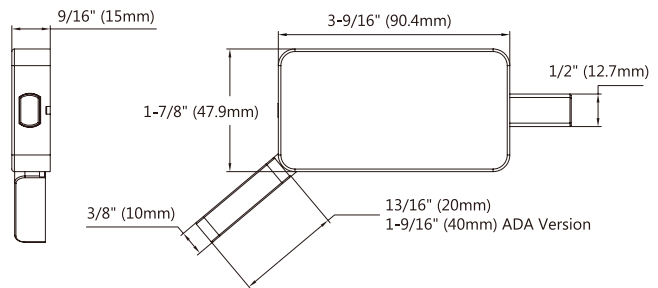

### STANDARD FINISHES

- 32D Satin Stainless Steel
- 32 Bright Stainless Steel
- 10B Oil Rubbed Bronze
- 4 Satin Brass
- 19G Graphite Black
- CeraMax Ceramic Coating: C19G Graphite Black, C19 Flat Black, CGY Stormy Grey, CDB Dark Bronze

*For additional finish options not listed, contact Sales Department for MOQ and lead times*

# WS90 WALL STRIKE

## for Lockable Sliding Barn Doors



### SPECIFICATIONS

<b>Door Thickness</b>	1-3/4" (45mm) Thick door kits available
<b>Strike Case Size</b>	2-7/16" x 1-3/4" x 1-9/16" (61.5mm x 44.75mm x 40mm)
<b>Strike Opening Size</b>	1-3/8" x 5/8" (35mm x 16mm)
<b>Material</b>	304 Stainless Steel
<b>Handing</b>	Non-Handed

### APPLICATION

Surface-mounted strike that enables sliding and barn doors to latch or lock. WS90 is the only modern design surface-mounted Wall Strike that works with sliding and barn doors.

Suitable for use with the INOX PD5000, PD8000, or PD9500. WS90 can be used in a wide range of applications, including but not limited to:

- Hospitality
- Multi-family & Mixed Use
- Commercial & Industrial
- Office Buildings

### FEATURES

- Designed as an effective, aesthetic solution to enable sliding and barn doors to surface latch
- Unique installation design ensures maximum strength and security via an interlocking mounting
- Concealed fixing with no visible set screws prevents hardware tampering
- Stainless Steel for maximum durability and high tolerance against heat and fire

### DIMENSIONS

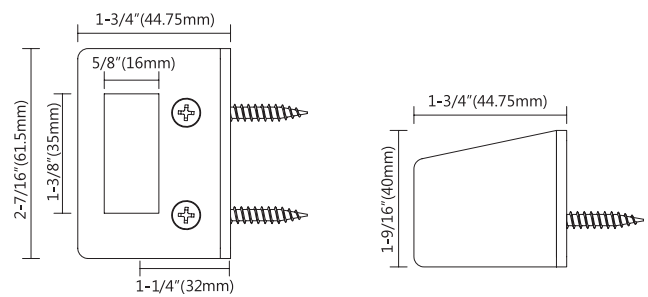

### STANDARD FINISHES

- 32D Satin Stainless Steel
- 19G Graphite Black
- CeraMax Ceramic Coating: C19G Graphite Black, C19 Flat Black, CGY Stormy Grey, CDB Dark Bronze

*For additional finish options not listed, contact Sales Department for MOQ and lead times*

# WS90L LARGE WALL STRIKE

for Lockable Sliding Barn Doors



## SPECIFICATIONS

<b>Door Thickness</b>	1-3/4" (45mm) Thick door kits available
<b>Strike Case Size</b>	4-1/4" x 1-3/4" x 1-9/16" (108mm x 45mm x 40mm)
<b>Strike Opening Size</b>	1-3/8" x 5/8" (35mm x 16mm)
<b>Material</b>	304 Stainless Steel
<b>Handing</b>	Non-Handed

## APPLICATION

WS90L is the only modern design surface-mounted Wall Strike that works with self-latching, self-locking sliding doors. It is suitable for use with the INOX PD96. WS90L can be used in a wide range of applications, including but not limited to: Hospitality, Multi-family & Mixed Use, Commercial & Industrial, Office Buildings

## ADDITIONAL SPACERS

Part Number	Description
<b>WS90L-SP2</b>	2mm Spacer
<b>WS90L-SP3</b>	3mm Spacer

## FEATURES

- Advanced engineered chassis; easily installed with no special tools
- Designed for use with the INOX PD96 lock
- Vandal-resistant anchored bracket
- Concealed fixing with no visible set screws prevents hardware tampering
- Vertically adjustable up to 1/2" for ease of installation
- Stainless Steel for maximum durability and high tolerance against heat and fire

## DIMENSIONS

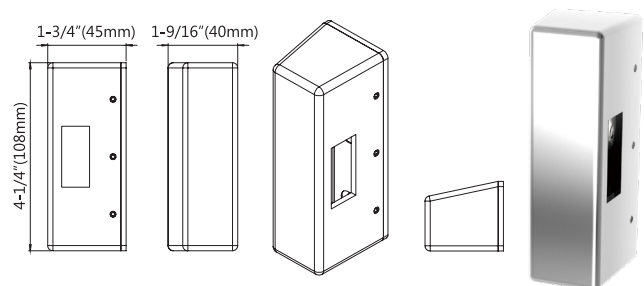

## STANDARD FINISHES

- 32D Satin Stainless Steel
- 19G Graphite Black
- CeraMax Ceramic Coating: C19G Graphite Black, C19 Flat Black, CGY Stormy Grey, CDB Dark Bronze

*For additional finish options not listed, contact Sales Department for MOQ and lead times*

# AMERICAN WITH DISABILITIES ACT COMPLIANCE

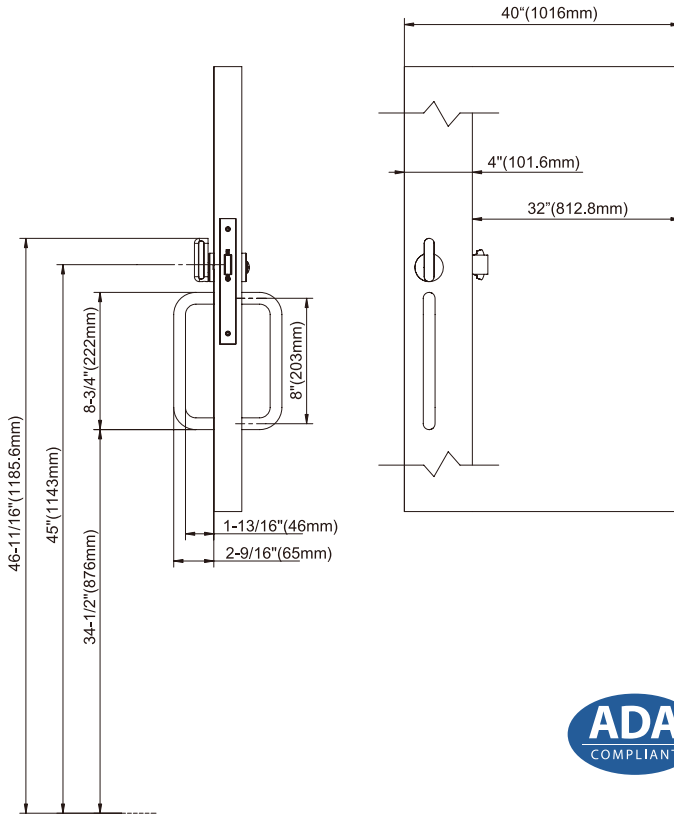

INOX ADA compliant pocket door hardware meets the "no grasp" and "no pinch" requirements of ADA Standard 4.13.9. The pocket door opening must have a clear width of 32" according to ADA Standard 404.2.3\*. When sliding doors are fully open, operating hardware shall be exposed and usable from both sides.

To accommodate these requirements, the total pocket door opening must be a MINIMUM of 40". The door must protrude a minimum of 4" from the jamb in order to install the ADA pocket door hardware on the door. The hardware must be installed 34" above the finished floor or ground, giving the hardware a height of 47" (the maximum is 48") from the finished floor, meeting ADA Standard 404.2.7.

**\*ADA Standard 404.2.3 is from the Department of Justice ADA Publication dated September 15, 2012. Unison Hardware, Inc. recommends the end user double check all State and Federal standards for your particular project.**





# ADA COMPLIANT SURFACE PULL OPTIONS

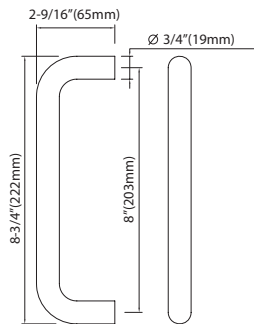

**PHIX31108**

## STANDARD FINISHES

- 32D Satin Stainless Steel
- 32 Bright Stainless Steel
- 19G Graphite Black
- CeraMax Ceramic Coating: C19G Graphite Black, C19 Flat Black, CGY Stormy Grey, CDB Dark Bronze

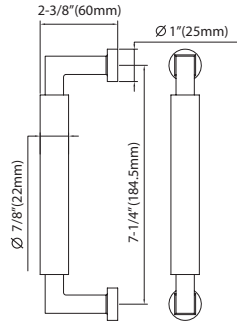

**PHIX41714**

## STANDARD FINISHES

- 32D Satin Stainless Steel
- 32 Bright Stainless Steel
- 19G Graphite Black
- CeraMax Ceramic Coating: C19G Graphite Black, C19 Flat Black, CGY Stormy Grey, CDB Dark Bronze

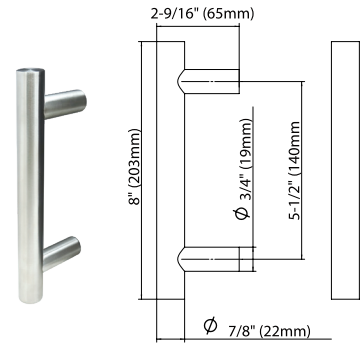

**PHIX330.512.8**

## STANDARD FINISHES

- 32D Satin Stainless Steel
- 32 Bright Stainless Steel
- 19G Graphite Black
- 26D Satin Chrome
- PVD4 Satin Brass
- CeraMax Ceramic Coating: C19G Graphite Black, C19 Flat Black, CGY Stormy Grey, CDB Dark Bronze

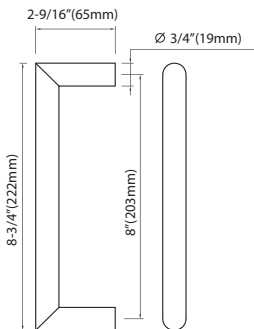

**PHIX30108**

## STANDARD FINISHES

- 32D Satin Stainless Steel
- 32 Bright Stainless Steel
- 19G Graphite Black
- CeraMax Ceramic Coating: C19G Graphite Black, C19 Flat Black, CGY Stormy Grey, CDB Dark Bronze

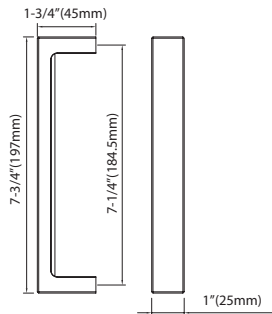

**PHIX45714**

## STANDARD FINISHES

- 32D Satin Stainless Steel
- 32 Bright Stainless Steel
- 10B Oil Rubbed Bronze
- 19G Graphite Black
- CeraMax Ceramic Coating: C19G Graphite Black, C19 Flat Black, CGY Stormy Grey, CDB Dark Bronze

For additional finish options not listed, contact Sales Department for MOQ and lead times

# SURFACE PULL OPTIONS

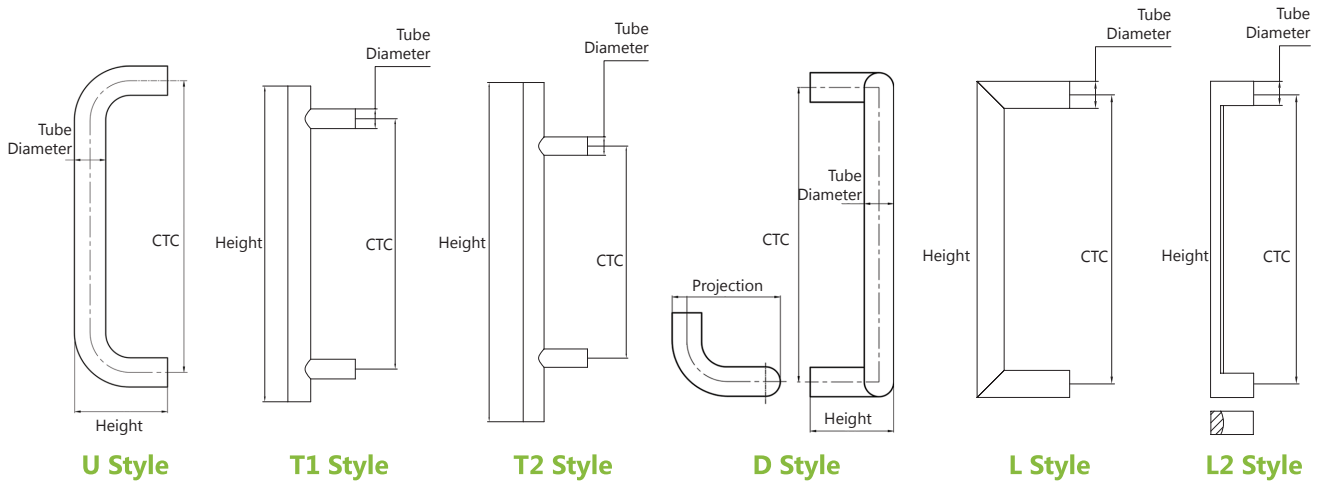

## FEATURES

- INOX PHIX Series door pulls are crafted with classic, timeless style. They are ideal for biophilic, ADA, and streamlined interior use
- Pulls are designed with clearance that meets ADA compliance specifications when installed in accordance with other ADA requirements (pull height, door opening space, etc.)
- Fixing packs for Bolt-Thru or Back-to-Back installation are included with each order; clear nylon washer and rubber inserts are included for glass door applications upon request

## CODE COMPLIANCE



- ANSI A156.6 – J401, J402, J406
- ANSI A117.1 – ADA for barrier free accessibility
- C-UBC - California Amended Uniform Builders Code
- NFPA 80 - National Fire Protection Association
- NFPA 101 - National Fire Protection - Life Safety

## STANDARD FINISHES

- 32D Satin Stainless Steel
- 32 Bright Stainless Steel
- 19G Graphite Black (Limited Styles available)
- CeraMax Ceramic Coating: C19G Graphite Black, C19 Flat Black, CGY Stormy Grey, CDB Dark Bronze

*For additional finish options not listed, contact Sales Department for MOQ and lead times*

Type	Length	CTC	Tube Dia.	Part Number
U Style	6-3/4"	6"	3/4"	<b>PHIX31106</b>
	8-3/4"	8"	3/4"	<b>PHIX31108</b>
	10-3/4"	10"	3/4"	<b>PHIX31110</b>
	12-3/4"	12"	3/4"	<b>PHIX31112</b>
	16-3/4"	16"	3/4"	<b>PHIX311.16.1675</b>
	18-3/4"	18"	3/4"	<b>PHIX311.18.1875</b>
	11"	10"	1"	<b>PHIX31210</b>
	13"	12"	1"	<b>PHIX31212</b>
	13-1/4"	12"	1-1/4"	<b>PHIX31312</b>
	19-1/4"	18"	1-1/4"	<b>PHIX31318</b>

# SURFACE PULL OPTIONS

Type	Length	CTC	Tube Dia.	Part Number
T1 Style	12"	9-1/2"	3/4"	<b>PHIX330.912.12</b>
	16"	13-1/2"	3/4"	<b>PHIX330.1312.16</b>
	18"	15-1/2"	3/4"	<b>PHIX330.1512.18</b>
	16"	13-1/4"	1-1/4"	<b>PHIX333.1325.16</b>
	18"	15-1/4"	1-1/4"	<b>PHIX333.1525.18</b>
	36"	33-1/4"	1-1/4"	<b>PHIX333.3325.36</b>
	48"	45-1/4"	1-1/4"	<b>PHIX333.4525.48</b>
T2 Style 90°	16"	12"	1"	<b>PHIX33212</b>
	16"	10"	1"	<b>PHIX332.10.16</b>
	18"	10"	1-1/4"	<b>PHIX33310</b>
	20"	12"	1-1/4"	<b>PHIX33312</b>
	26"	18"	1-1/4"	<b>PHIX33318</b>
	56"	48"	1-1/4"	<b>PHIX33348</b>
	68"	60"	1-1/4"	<b>PHIX33360</b>
T2 Style 45°	18"	10"	1-1/4"	<b>PHIX34310</b>
	20"	12"	1-1/4"	<b>PHIX34312</b>
	26"	18"	1-1/4"	<b>PHIX34318</b>
D Style	11"	10"	1"	<b>PHIX32210</b>
	13"	12"	1"	<b>PHIX32212</b>
	13-1/4"	12"	1-1/4"	<b>PHIX32312</b>
L Style	19-1/4"	18"	1-1/4"	<b>PHIX32318</b>
	8-3/4"	8"	3/4"	<b>PHIX30108</b>
	16-3/4"	16"	3/4"	<b>PHIX301.16.1675</b>
L2 Style	18-1/4"	18"	1-1/4"	<b>PHIX303.18.1925</b>
	12-3/4"	12"	1"	<b>PHIX45012</b>

For additional finish options not listed, contact Sales Department for MOQ and lead times

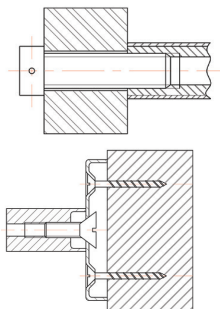

All Surface Pulls are available as either **Bolt-Thru**, a single pull (function code **BT**) with BT fixing pack; or **Back-to-Back** (function code **BTB**), two pulls and one Back-to-Back fixing pack.

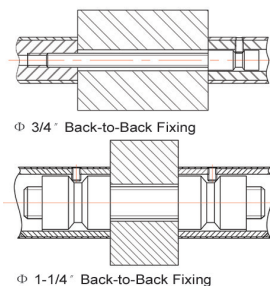

## MORTISE CYLINDERS

### MORTISE CYLINDERS AND KEYS

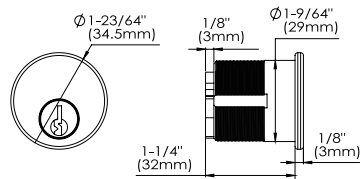

Schlage C Keyway, 6 Pin, with Clover Cam, 2 Keys  
 Standard Keyed Different (KD)  
 Other Keying Services available  
 Other sizes or keyway cylinders available. Order separately.

Illustration	Item Code	Description	Size	ANSI
<i>Mortise Cylinders</i>				
	<b>CMB105</b>	Mortise Cylinder, Schlage C Keyway, 5 pin, L Cam	1"	E09211
	<b>CMB1186</b>	Mortise Cylinder, Schlage C Keyway, 6 pin, L Cam	1-1/8"	E09211
	<b>CMB1146</b>	Mortise Cylinder, Schlage C Keyway, 6 pin, L Cam	1-1/4"	E09211
	<b>CMB1386</b>	Mortise Cylinder, Schlage C Keyway, 6 pin, L Cam	1-3/8"	E09211
	<b>CMB1126</b>	Mortise Cylinder, Schlage C Keyway, 6 pin, L Cam	1-1/2"	E09211
	<b>CMB1346</b>	Mortise Cylinder, Schlage C Keyway, 6 pin, L Cam	1-3/4"	E09211
<i>Dummy Cylinders</i>				
	<b>CMB1140DM*</b>	Mortise Dummy Cylinders, No Cam	1-1/4"	E09211

\* Dummy function lockset does not include dummy cylinder. Dummy cylinder ordered separately if required.

### INTERCHANGEABLE (IC) CORE HOUSING WITH REMOVABLE MORTISE CAM

Solid Brass/ Small Format (SFIC) Housing  
 Standard L Cam included for MC7000 Series mortise lock  
 Accepts Best, Arrow and Falcon Cores

Illustration	Item Code	Description	Size	ANSI
	<b>CMB1146-ICBA-HUS</b>	SFIC Mortise Cylinder Housing, 6 Pin	1-1/4"	E09241
	<b>CMB1386-ICBA-HUS</b>	SFIC Mortise Cylinder Housing, 6 Pin	1-3/8"	E09241
	<b>CMB1126-ICBA-HUS</b>	SFIC Mortise Cylinder Housing, 6 Pin	1-1/2"	E09241
	<b>CMB1586-ICBA-HUS</b>	SFIC Mortise Cylinder Housing, 6 Pin	1-5/8"	E09241
	<b>CMB1387-ICBA-HUS</b>	SFIC Mortise Cylinder Housing, 7 Pin	1-3/8"	E09241
	<b>CMB1127-ICBA-HUS</b>	SFIC Mortise Cylinder Housing, 7 Pin	1-1/2"	E09241
	<b>CMB1587-ICBA-HUS</b>	SFIC Mortise Cylinder Housing, 7 Pin	1-5/8"	E09241
	<b>CMB1126-LFIC-HUS</b>	LFIC Mortise Cylinder Housing, 6 Pin	1-1/2"	E09241

### INTERCHANGEABLE CORES ONLY

Solid brass plug and housing / Small Format (SFIC) Core in Best A Keyway  
 2 Change keys per Combined Core – A2 System Only  
 1 master key or grandmaster key included per group/order

1 Control key per group/order  
 6 or 7 pin cores replace Arrow, Best, Falcon Construction or Combined Core

Illustration	Item Code	Description	ANSI
	<b>CMB-ICBA6-CST</b>	SFIC Core Only, Best A Keyway, 6 Pin, Construction	E09251
	<b>CMB-ICBA6-CMB</b>	SFIC Core Only, Best A Keyway, 6 Pin, Combined	E09251
	<b>CMB-ICBA7-CMB</b>	SFIC Core Only, Best A Keyway, 7 Pin, Combined	E09251
	<b>CMB-LFIC-SC6-CMB</b>	LFIC Core Only, Schlage C Keyway, 6 Pin, Combined	E09251

## KEYS

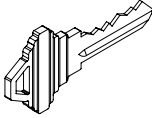
Illustration	Item Code	Description
	<b>LSK-6SC-NP</b>	Standard key Schlage C Keyway for 6 Pin, Nickel Plated
	<b>LSK01-6SC-NS-DND</b>	DND Nickel Silver Key, Schlage C Keyway for 6 Pin w/ "Do Not Duplicate"
	<b>LSK06-BA-CRK</b>	Extra Control Key for IC Core, Best A Keyway
	<b>LSK06-BA-MK</b>	Extra Master Key for IC Core, Best A Keyway
	<b>LSK06-BA-GMK</b>	Extra Grand Master Key for IC Core, Best A Keyway

## KEYING SERVICES

Description	Item No.
Service: Key Cut including Key Blank	<b>SV-KYCT</b>
Service: Keyed Alike (KA)	<b>SV-KA</b>
Service: Keyed Alike Pair	<b>SV-KA2</b>
Service: Keyed Alike Group (Specify Number of Keyed Alike Per Group)	<b>SV-KA (Number)</b>
Service: Keyed to Specific Code	<b>SV-KS</b>
Service: Master Keying	<b>SV-MK</b>
Service: Grandmaster Keying with 2 or more Master groups	<b>SV-GMK</b>
Service: Construction Master Keying Service	<b>SV-CMK</b>
Service: Great Grandmaster Key	<b>SV-GGMK</b>

Description	Item No.
Service: IC Core Key Cut including Key Blank	<b>SV-ICKYCT</b>
Service: IC Core Keyed Alike (KA) - Each cylinder in the group is keyed alike	<b>SV-ICKA</b>
Service: IC Core Keyed to Specific Code - Cylinder is keyed to a specific code	<b>SV-ICKS</b>
Service: IC Core Master Keying - 2 Change Keys per Cylinder and 3 Master Keys per MK	<b>SV-ICMK</b>
Service: IC Core Grand Master Keying (2 or more MK groups included)	<b>SV-ICGMK</b>

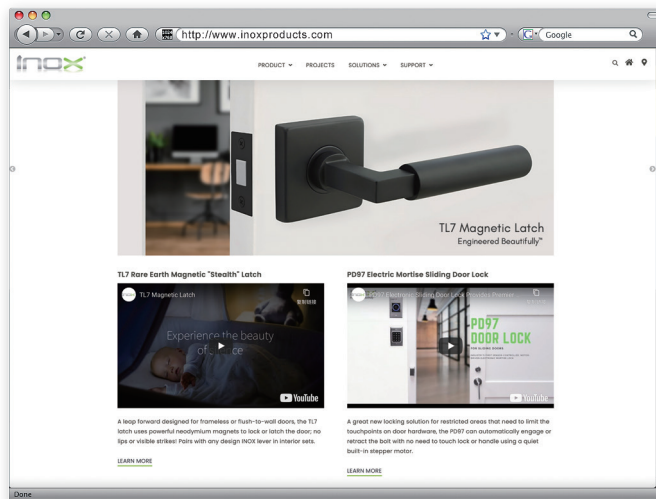

Please visit our website  
[www.inoxproducts.com](http://www.inoxproducts.com)  
for more technical and new product information.

---

**Unison Hardware, Inc.**  
6 Wayne Court, Sacramento CA 95829, USA Tel: +1.916.388.1888  
Email: [info@unisonhardware.com](mailto:info@unisonhardware.com)