

ANSI/BHMA GRADE 1
Cylindrical Locks

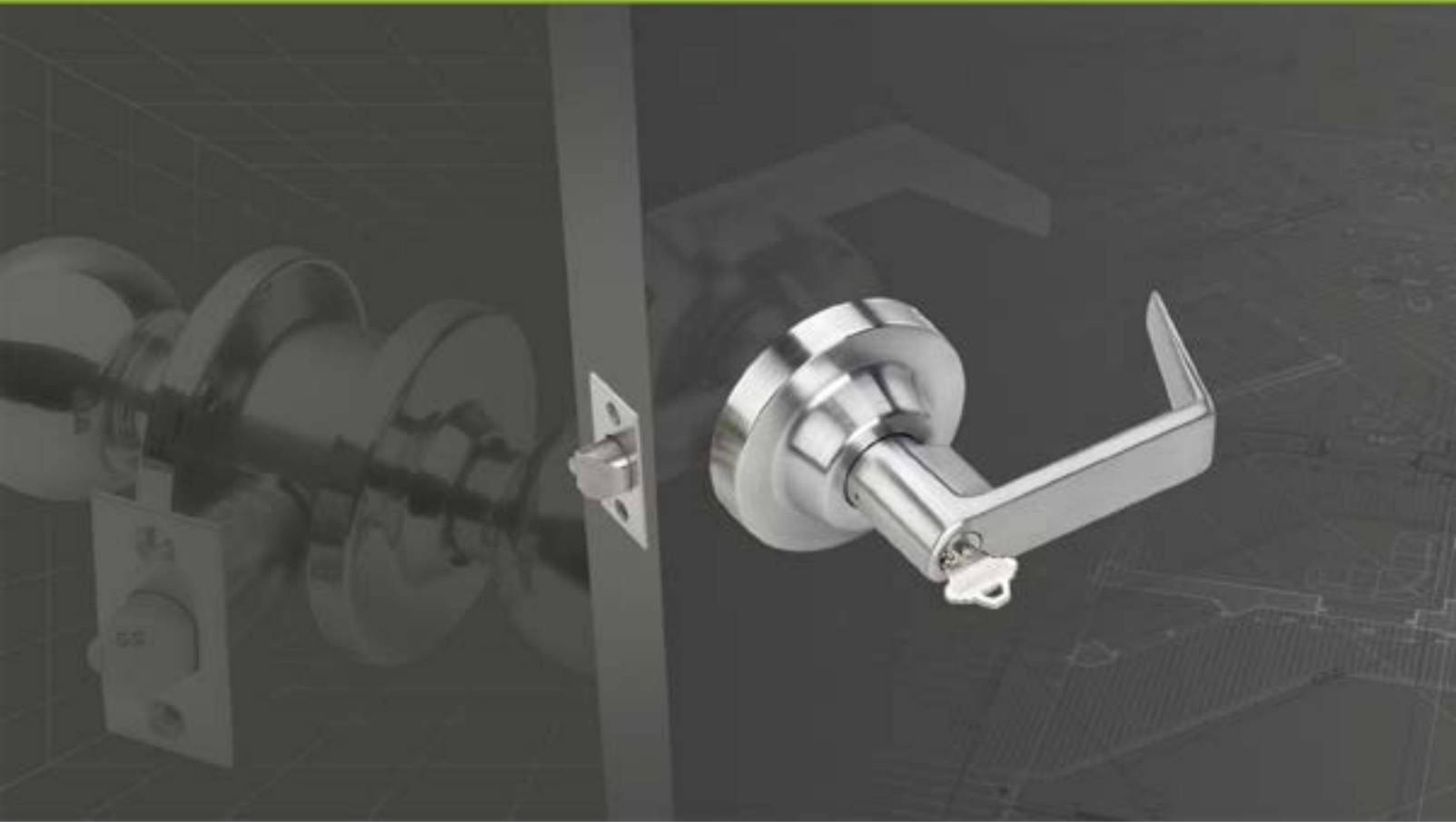

CL Cylindrical Locksets

BL Cylindrical Locks

CX/BX Deadbolts

CONTENTS



Grade 1 CL Cylindrical Locksets

- Page 01** CL Cylindrical Locksets Overview
- Page 02** CL Series Specifications
- Page 03** CL Series Lever Designs
- Page 04** CL Series Functions
- Page 05** Latches
- Page 16** Cylinders, Strike Plates and Keying Services
- Page 18** Electrification Locks Service Codes
- Page 19** Cross Referenes



Grade 2 BL Cylindrical Locks

- Page 06** BL Cylindrical Lockset
- Page 07** BL Series Specifications
- Page 08** BL Series Lever Designs
- Page 09** BL Series Functions
- Page 10** Latches
- Page 16** Cylinders, Strike Plates and Keying Services
- Page 18** Electrification Locks Service Codes
- Page 19** Cross References



CX/BX Deadbolts

- Page 11** CX Grade 1
- Page 12** CX Grade 1 Deadbolt Specifications
- Page 13** BX Grade 2 Deadbolt
- Page 14** BX Grade 2 Deadbolt Specifications
- Page 20** CX and BX Functions
- Page 16** Cylinders, Strike Plates and Keying Services
- Page 20** Cross References

Disclaimer: All information in this catalog has been deemed accurate as of the date of printing. We are continuously improving and expanding our line in an effort to offer our clients the finest quality products and services; therefore, Unison Hardware, Inc., reserves the right to alter this information or correct printing errors at any time.

©2022 Unison Hardware, Inc. All Rights Reserved. June 2022

CYLINDRICAL LOCK

CL Series Grade 1

Coil compression springs provide greater strength and durability

Optional removeable Thru Bolt

Concealed screw mounting

Full length lever handle with 3/8" return

Cylindrical body for top strength and longevity

UL 3 hour rated 1/2" Throw deadlatch completely reversible for flat and beveled doors. Stainless Steel latch bolt

High precision pick-resistant 6-pin solid brass cylinder, interchangeable with other leading manufacturers' cylinders. Turn key one-quarter turn to remove and replace cylinder. Can be construction keyed and master keyed as required

Individual spring on each side to prevent lever sag, maintain reliability, reduce maintenance



COMMERCIAL CYLINDRICAL LOCKS

CL Leversets Grade 1

SPECIFICATIONS

Door Thickness	1-3/8" (35mm) ~ 2" (51mm) standard doors
Door Prep	Crossbore 2-1/8" (54mm), Edgebore 1" (25mm), Latch face 2-1/4" (57mm) x 1-1/8" (28.6mm)
Backset	2-3/4" (70mm) standard 2-3/8" (60mm) and 5" (127mm) optional
Cylinder	6-pin anti-pick, solid brass cylinder
Keys	Two (2) keys per lock. Schlage C keyway Keyed-Different standard Keyed-Alike, Construction key, Master key suite, or other keyways available by special order
Handing	Non-handed
Trim	Solid zinc diecast levers 55° lever rotation for full latch retraction
Clutch Function (CL)	Outside lever free wheeling while locked to prevent vandalism
Rose	3-9/16" (90mm) diameter Brass roses with concealed screws Threaded interior and exterior roses Removable thru bolts
Latchbolt	1/2" (12.7mm) throw, Stainless Steel 3 hour fire rated latchbolt Reversible for flat and beveled doors
Faceplate	2-1/4" (57mm) x 1-1/8" (28.6mm) square corner standard. Stainless Steel or brass faceplate
Strike	ANSI curved lip strike 4-7/8" (124mm) x 1-1/4" (32mm) x 1-1/4" (32mm) lip to center standard. Full lip strike or T strike available

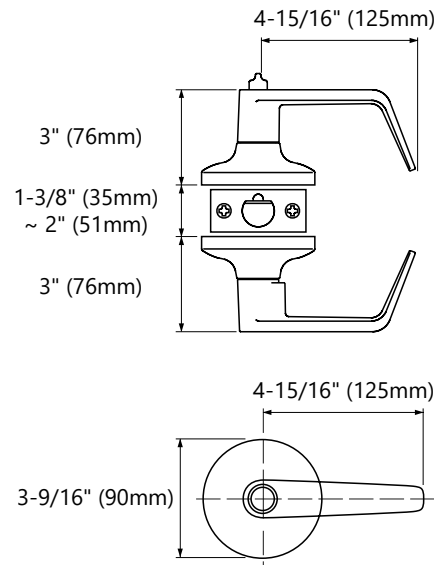

CODE COMPLIANCE



ANSI A156.2 Grade 1, UL 10C and UBC 7.2 for positive pressure
ANSI A117.1 ADA Barrier-free Accessibility
C-UBC California Uniform Builders Code-2001
NFPA-80 National Fire Protection-1999
NFPA-101 National Fire Protection-Life Safety-2000

LEVER DESIGNS

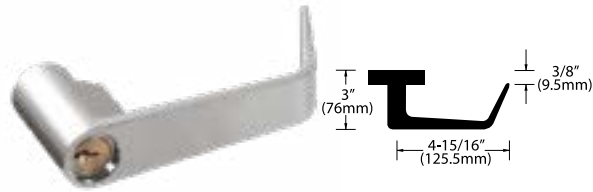

07 IN STOCK

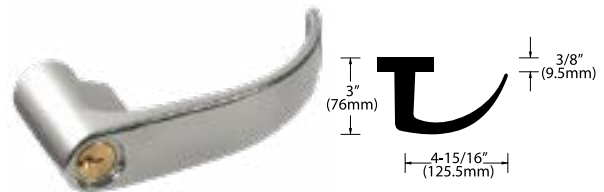

09 IN STOCK



06 SPECIAL ORDER

Type	Description	Part Number	Standard Finish
Non-Keyed Lock	Passage Lock	CL0710	19G Graphite Black 10B Oil Rubbed Bronze 26D Satin Chrome
	Privacy Lock	CL0740	19G Graphite Black 10B Oil Rubbed Bronze 26D Satin Chrome
	Single Dummy Trim	CL0717	19G Graphite Black 10B Oil Rubbed Bronze 26D Satin Chrome
	Passage Lock	CL0910	26D Satin Chrome
	Privacy Lock	CL0940	26D Satin Chrome
Keyed Lock	Office Lock	CL0750	19G Graphite Black
	IC Core Option	CL0750IC	10B Oil Rubbed Bronze 26D Satin Chrome
	Entrance Lock	CL0753	19G Graphite Black
	IC Core Option	CL0753IC	10B Oil Rubbed Bronze 26D Satin Chrome
	Classroom Lock	CL0770	19G Graphite Black
	IC Core Option	CL0770IC	10B Oil Rubbed Bronze 26D Satin Chrome
	Storeroom Lock	CL0780	19G Graphite Black
	IC Core Option	CL0780IC	10B Oil Rubbed Bronze 26D Satin Chrome
	Office Lock	CL0950	26D Satin Chrome
Entrance Lock	CL0953	26D Satin Chrome	
Classroom Lock	CL0970	26D Satin Chrome	
Storeroom Lock	CL0980	26D Satin Chrome	

For additional finish options and functions not listed, contact Sales Department for MOQ and lead times

FUNCTIONS

Non Keyed Locks

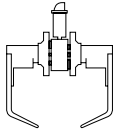

10 (ANSI: F75)

Passage Latch

Both levers are always unlocked from inside and outside

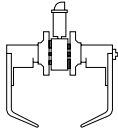

40 (ANSI: F76)

Privacy Lock

Outside lever is locked by push button inside
Outside lever is unlocked by emergency release outside, rotating inside lever or closing door
Inside lever is always free for emergency exit

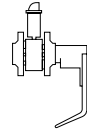

25 (ANSI: F111)

Exit/Communicating Lock

Inside lever is always unlocked
Blank plate outside
Inside lever is always free for emergency exit

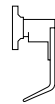

17

Single Dummy Trim

Single dummy trim for one side

Keyed Locks

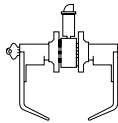

50 (ANSI: F82)

Entrance/Office Lock

Push button locks outside lever
Key outside releases push button, unlocking outside lever
Operating inside lever releases push button, unlocking outside lever
Inside lever is always free for emergency exit

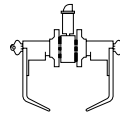

75 (ANSI: F110)

Intruder Classroom Lock

Outside lever is locked or unlocked by key from either side
When unlocked, the lockset works as a passage set
When locked, key required from either outside or inside to unlock the lockset
Inside lever is always unlocked for emergency exit

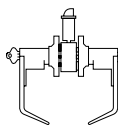

53 (ANSI: F109)

Entrance Lock

Push and turn button to keep outside lever locked. Key is always required to unlock the outside lever until button is reset
Push button only locks outside lever until it is unlocked by key or by turning inside lever
Key releases outside lever and push button inside, except when inside button is pushed and turned to keep outside lever locked
Inside lever always free for emergency exit

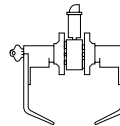

80 (ANSI: F86)

Storeroom Lock

Outside lever is unlocked only while key is turned
Inside lever is always free for emergency exit

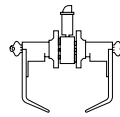

66 (ANSI: F91)

Store Door Lock

Key from either inside or outside locks or unlocks both levers
When unlocked, latch bolt operates by lever from either side

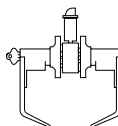

70 (ANSI: F84)

Classroom Lock

Outside lever is locked or unlocked by key
When unlocked the lockset works as a passage set
When locked, key required from outside to unlock the lockset
Inside lever is always unlocked for emergency exit

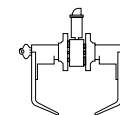

82 (ANSI: F87)

Institution Lock

Both levers are always inoperable
Entrance by key in lever from either side

LATCHES

Deadlatches and Spring Latches



LSL06N
2-3/8" Spring Latch
1-1/8" Faceplate



LSL06K
2-3/8" Dead Latch
1-1/8" Faceplate



LSL07N
2-3/4" Spring Latch
1-1/8" Faceplate



LSL07K
2-3/4" Dead Latch
1-1/8" Faceplate



LSL08N
5" Spring Latch
1-1/8" Faceplate



LSL08K
5" Dead Latch
1-1/8" Faceplate



LSK-EX15
Extension for 5" Backset

Series	Description	Part Number	Standard Finish
CL Series	2-3/8" Spring Latch 1-1/8" Faceplate	LSL06N	19G Graphite Black 10B Oil Rubbed Bronze 26D Satin Chrome
	2-3/8" Dead Latch 1-1/8" Faceplate	LSL06K	19G Graphite Black 10B Oil Rubbed Bronze 26D Satin Chrome

For additional finish options not listed, contact Sales Department for MOQ and lead times

CYLINDRICAL LOCK

BL Series Grade 2

Coil compression springs provide greater strength and durability

Optional removeable Thru Bolt

Push in and turn button functions

Full length lever handle with 3/8" return

Concealed screw mounting

Cylindrical body provides top strength and reliability

Two-sided spindle support mechanism eliminates lever wobble

High precision pick-resistant 6-pin solid brass cylinder. MK, CMK, GMK keying services available

UL 3 hour rated 1/2" throw deadlatch completely reversible for flat and beveled doors. Stainless Steel latch bolt and faceplate included

Individual spring on each side to prevent lever sag, maintain dependability, reduce maintenance

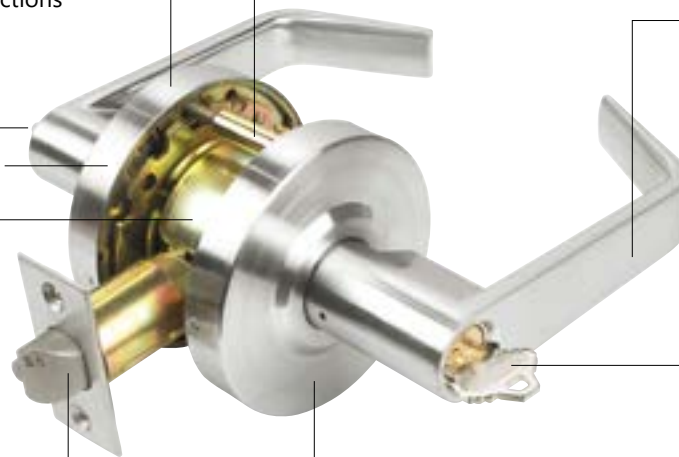

COMMERCIAL CYLINDRICAL LOCKS

BL Leversets Grade 2

SPECIFICATIONS

Door Thickness	1-1/2" (38mm) ~ 2" (51mm) standard doors
Door Prep	Standard 161 prep. w/optional thru-bolts Crossbore 2-1/8" (54mm) Edgebore 1" (25mm), Latch face 1-1/8" (28.6mm) x 2-1/4" (57mm)
Backset	2-3/4" (70mm) standard 2-3/8" (60mm) and 5" (127mm) optional
Cylinder	6-pin anti-pick tumbler, solid brass cylinder
Keys	Two (2) keys per lock. Schlage C keyway Keyed-Different standard Keyed-Alike, Construction key, Master key suite, or other keyway available by special order
Handing	Non-handed
Trim	Solid zinc diecast levers 55° lever rotation for full latch retraction
Clutch Function (CL)	Outside lever free wheeling while locked to prevent vandalism
Rose	3-3/8" (86mm) diameter. Brass roses with concealed screws Threaded interior and exterior roses Removable thru bolts
Latchbolt	1/2" (12.7mm) throw, Stainless Steel 3 hour fire-rated latchbolt Reversible for flat and beveled doors
Faceplate	1-1/8" (28.6mm) x 2-1/4" (57mm) square corner standard. Stainless Steel or brass faceplate
Strike	ANSI curved lip strike 4-7/8" (124mm) x 1-1/4" (32mm) x 1-1/4" (32mm) lip to center standard. Full lip strike or T strike available

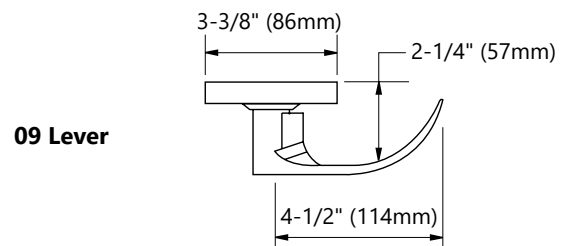
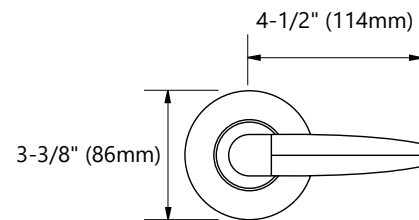
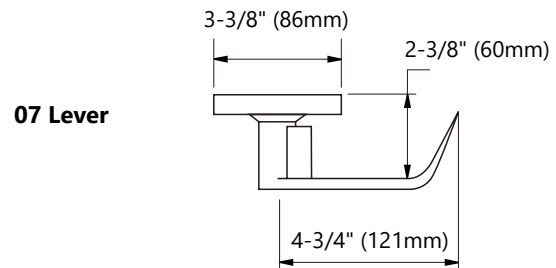
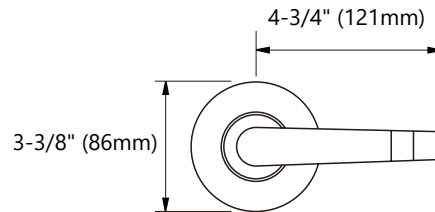

CODE COMPLIANCE



ANSI A156.2 Grade 1, UL 10C and UBC 7.2 for positive pressure
ANSI A117.1 ADA Barrier-free Accessibility
C-UBC California Uniform Builders Code-2001
NFPA-80 National Fire Protection-1999
NFPA-101 National Fire Protection-Life Safety-2000

LEVER DESIGNS

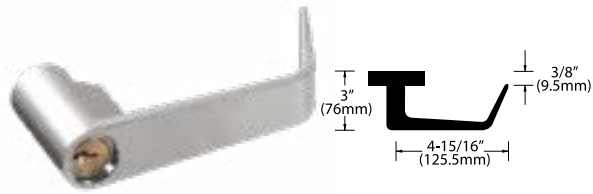

07 IN STOCK

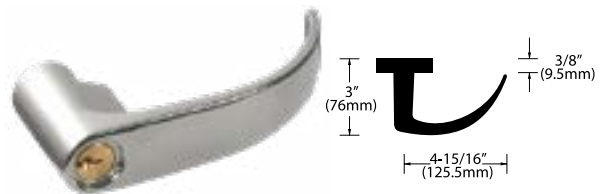

09 IN STOCK

Type	Description	Part Number	Standard Finish
Non-Keyed Lock	Passage Lock	BL0710 BL0910	19G Graphite Black 10B Oil Rubbed Bronze 26D Satin Chrome 26 Polished Chrome
	Privacy Lock	BL0740 BL0940	19G Graphite Black 10B Oil Rubbed Bronze 26D Satin Chrome 26 Polished Chrome
	Communicating / Exit Lock	BL0725 BL0925	19G Graphite Black 10B Oil Rubbed Bronze 26D Satin Chrome 26 Polished Chrome
	Single Dummy Trim	BL0717 BL0917	19G Graphite Black 10B Oil Rubbed Bronze 26D Satin Chrome 26 Polished Chrome
Keyed Locks	Entrance Lock	BL0753 BL0953	19G Graphite Black 10B Oil Rubbed Bronze 26D Satin Chrome 26 Polished Chrome
	Classroom Lock	BL0770 BL0970	19G Graphite Black 10B Oil Rubbed Bronze 26D Satin Chrome 26 Polished Chrome
	Storeroom Lock	BL0780 BL0980	19G Graphite Black 10B Oil Rubbed Bronze 26D Satin Chrome 26 Polished Chrome
Clutch Keyed Locks	Entrance Lock	BL0753CL BL0953CL	19G Graphite Black 10B Oil Rubbed Bronze 26D Satin Chrome 26 Polished Chrome
IC Core Option	Entrance Lock	BL0753IC	19G Graphite Black 26D Satin Chrome
	Classroom Lock	BL0770IC	19G Graphite Black 26D Satin Chrome
	Storeroom Lock	BL0780IC	19G Graphite Black 26D Satin Chrome

For additional finish options not listed, contact Sales Department for MOQ and lead times

FUNCTIONS

Non Keyed Locks

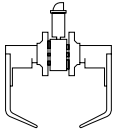

10 (ANSI: F75)

Passage Latch

Both levers are always unlocked from inside and outside

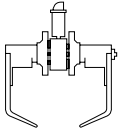

40 (ANSI: F76)

Privacy Lock

Outside lever is locked by push button inside
Outside lever is unlocked by outside emergency release, rotating inside lever or closing door

Inside lever is always free for emergency exit

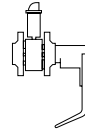

25 (ANSI: F111)

Exit/Communicating Lock

Inside lever is always unlocked
Blank plate outside
Inside lever is always free for emergency exit

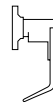

17

Single Dummy Trim

Single dummy trim for one side

Keyed Locks

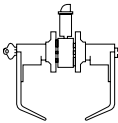

53 (ANSI: F109)

Entrance Lock

Push and turn button to keep outside lever locked. Key is always required to unlock the outside lever until button is reset
Push button only locks outside lever until it is unlocked by key or by turning inside lever
Key releases outside lever and push button inside, except when inside button is pushed and turned to keep outside lever locked
Inside lever always free for emergency exit

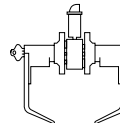

70 (ANSI: F84)

Classroom Lock

The outside lever is locked or unlocked by key
When unlocked the lockset works as a passage set
When locked, key required from outside to unlock the lockset
The inside lever is always unlocked for emergency exit

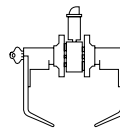

80 (ANSI: F86)

Storeroom Lock

Outside lever is unlocked only while key is turned
Inside lever is always free for emergency exit

LATCHES

Dead Latches and Spring Latches



LSL01N
2-3/8" Spring Latch
1-1/8" Faceplate



LSL01K
2-3/8" Dead Latch
1-1/8" Faceplate



LSL02N
2-3/4" Spring Latch
1-1/8" Faceplate



LSL02K
2-3/4" Dead Latch
1-1/8" Faceplate



LSL03N
5" Spring Latch
1-1/8" Faceplate



LSL03K
5" Dead Latch
1-1/8" Faceplate



LSK-EX25
Extension for 5" Backset

Series	Description	Part Number	Standard Finish
BL	2-3/8" Spring Latch 1-1/8" Faceplate	LSL01N	19G Graphite Black 10B Oil Rubbed Bronze 26D Satin Chrome
	2-3/8" Dead Latch 1-1/8" Faceplate	LSL01K	19G Graphite Black 10B Oil Rubbed Bronze 26D Satin Chrome
	2-3/4" Spring Latch 1-1/8" Faceplate	LSL02N	19G Graphite Black 10B Oil Rubbed Bronze 26D Satin Chrome
	2-3/4" Dead Latch 1-1/8" Faceplate	LSL02K	19G Graphite Black 10B Oil Rubbed Bronze 26D Satin Chrome

For additional finish options not listed, contact Sales Department for MOQ and lead times

DEADBOLT

CX Series Grade 1

ADA ergonomic solid brass thumbturn

2-1/2" diameter solid forged brass anti-torque housing design. Exceeds ANSI Grade 1 security against hammer and crowbar prying attacks



1" (25mm) throw solid brass deadbolt with hardened steel core. Exceeds ANSI Grade 1 Security against kick-in and saw attacks

High precision pick-resistant solid brass 6 pin cylinder with anti-drill ball bearings in "C" Keyway. Meets ANSI Grade 1 Security. Brass Keys included

Strong all steel latch case and mechanism

HEAVY DUTY COMMERCIAL DEADBOLT

CX Deadbolt Grade 1

SPECIFICATIONS

Door Thickness	1-9/16" (40mm) ~ 2" (51mm) doors standard
Backset	2-3/8" (60mm) or 2-3/4" (70mm)
Handing	Non-handed
Exposed Trim	2-1/2" (63.5mm) diameter solid brass, one-piece design exceeds BHMA/ANSI Grade 1 security against hammer and crowbar prying attacks
Faceplate	1-1/8" (28.6mm) x 2-1/4" (57mm) with square corners; Stainless Steel or brass
Dead Bolt	1" (25mm) throw deadbolt with saw-resistant hardened steel core
Strike	1-1/8" (28.6mm) x 2-3/4" (70mm) with steel reinforcement
Cylinder & Keys	6-pin anti-pick cylinder in Schlage C keyway keyed different with 2 brass keys per lock. Small Format Interchangeable Core (SFIC) available by specifying IC core; please order separately
Keying Options	Keyed Alike, Master keying, Grand Master Keying, and Construction Keying available by special order. Nickel silver keys available by special order

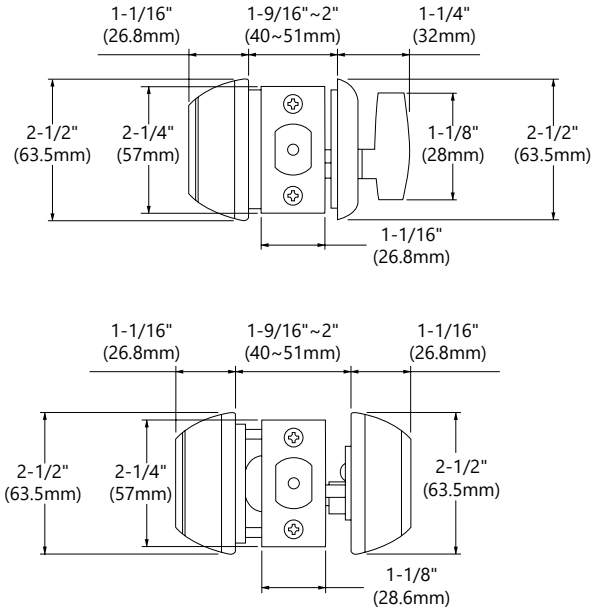

CODE COMPLIANCE



ANSI/BHMA A156.36 & A156.5 Grade 1
 UL Listed for UL10B and UL10C, up to 3 Hours
 UBC Standard 7-2 (1997) NFPA 252
 NFPA 80 National Fire Protection-Fire Door Assembly
 NFPA101 National Fire Protection-Life Safety
 ANSI/BHMA A156.18 Finishes
 ANSI A117.1 ADA Accessibility

Description	Part Number	Standard Finish
Single Cylinder Deadbolt	CX660	19G Graphite Black 10B Oil Rubbed Bronze 26D Satin Chrome
Double Cylinder Deadbolt	CX662	10B Oil Rubbed Bronze 26D Satin Chrome
Single Cylinder IC Core	CX660IC	26D Satin Chrome

For additional finish options and functions not listed, contact Sales Department for MOQ and lead times

DEADBOLT

BX Series Grade 2

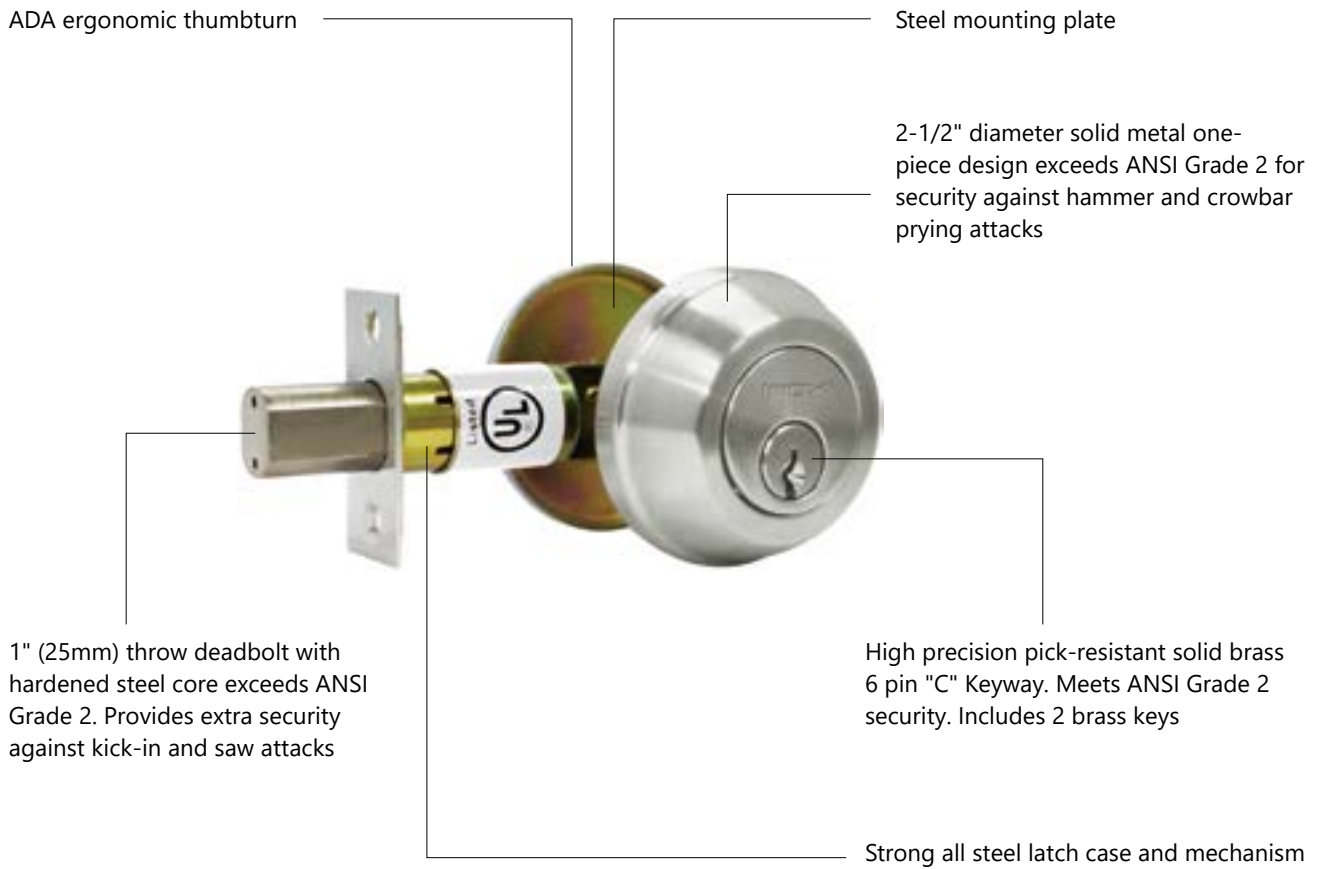

STANDARD DUTY COMMERCIAL DEADBOLT

BX Deadbolt Grade 2

SPECIFICATIONS

Door Thickness	1-3/8" (35mm) ~ 2" (51mm) doors standard
Backset	2-3/8" (60mm) or 2-3/4" (70mm)
Handing	Non-handed
Exposed Trim	2-1/2" (63.5mm) diameter solid cast alloy, one-piece design exceeds BHMA/ANSI Grade 2 security against hammer and crowbar prying attacks
Faceplate	1-1/8" (28.6mm) x 2-1/4" (57mm) Stainless Steel or brass faceplate with square corners radius corner available by special order
Dead Bolt	1" (25mm) throw deadbolt with saw-resistant hardened steel core
Strike	1-1/8" (28.6mm) x 2-3/4" (70mm) with steel reinforcement
Cylinder & Keys	6-pin anti-pick cylinder in Schlage C keyway keyed different with 2 brass keys per lock. Small Format Interchangeable Core (SFIC) available by specifying IC core, please order separately
Keying Options	Keyed Alike, Master Keying, Grand Master Keying, and Construction Keying available by special order. Nickel silver keys available by special order

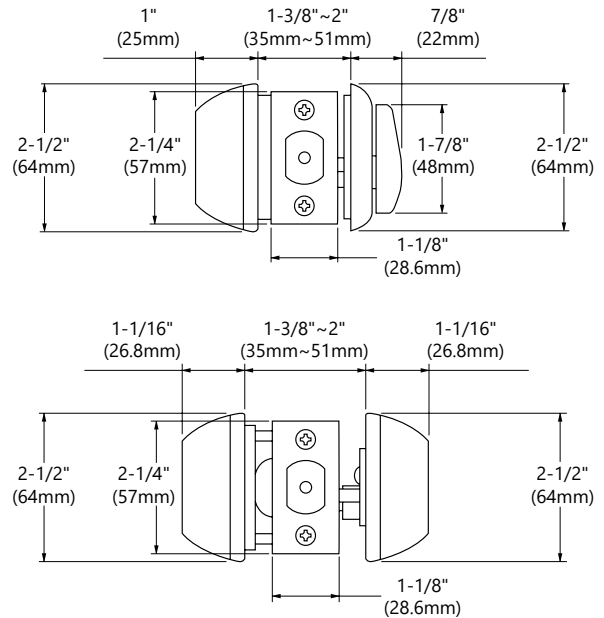

CODE COMPLIANCE



ANSI/BHMA A156.36 & A156.5 Grade 2
 UL Listed for UL10B and UL10C, up to 3 Hours
 UBC Standard 7-2 (1997) NFPA 252
 NFPA80 National Fire Protection-Fire Door Assembly
 NFPA101 National Fire Protection-Life Safety
 ANSI/BHMA A156.18 Finishes
 ANSI A117.1 ADA Accessibility

Description	Part Number	Standard Finish
Single Cylinder Deadbolt	BX660	19G Graphite Black 10B Oil Rubbed Bronze 26 Polished Chrome 26D Satin Chrome
Double Cylinder Deadbolt	BX662	19G Graphite Black 10B Oil Rubbed Bronze 26 Polished Chrome 26D Satin Chrome
Single Cylinder IC Core	BX660IC	26D Satin Chrome

For additional finish options and functions not listed, contact Sales Department for MOQ and lead times

FUNCTIONS

CX Deadbolt Grade 1

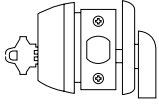

CX660 (ANSI: E1251)

Single Cylinder

Deadbolt thrown or retracted by key outside or thumbturn inside
Bolt automatically deadlocks when fully thrown

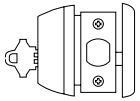

CX661 (ANSI: E2161)

Cylinder Only x Blank Plate

Deadbolt thrown or retracted by key outside
Blank plate with exposed screws inside

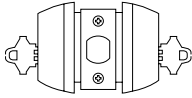

CX662 (ANSI: E2141)

Double Cylinder

Deadbolt thrown or retracted by key from either side
Bolt automatically deadlocks when fully thrown

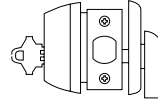

CX663 (ANSI: E2171)

Classroom Deadbolt

Deadbolt thrown by key outside only
Deadbolt retracted by key outside or thumbturn inside

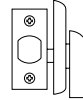

CX680 (ANSI: E2191)

Door Bolt

Deadbolt operated by thumbturn only. No outside trim. Bore halfway through door for installation visible from one side of door only

BX Deadbolt Grade 2

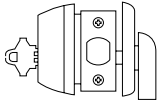

BX600 (ANSI: E0152)

Single Cylinder

Deadbolt thrown or retracted by key outside or thumbturn inside
Bolt automatically deadlocks when fully thrown

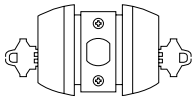

BX662 (ANSI: E0142)

Double Cylinder

Deadbolt thrown or retracted by key from either side
Bolt automatically deadlocks when fully thrown

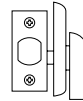

BX680 (ANSI: E0192)

Door Bolt

Deadbolt operated by thumbturn only. No outside trim. Bore halfway through door for installation visible from one side of door only

CYLINDERS

RIM CYLINDERS

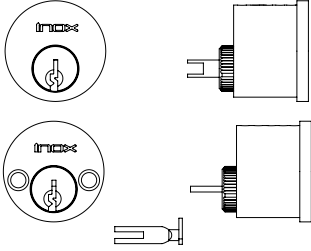
Illustration	Item Code	Description	ANSI
	CRZ106	Single Cylinder in Lever, 6 Pin with Tailpiece, Schlage C Keyway 2 Keys, Standard Keyed Different (KD). Other Keying Services are available.	E09221
	CRZ106F CRZ106HR	Double Cylinder in Lever, 6 Pin with Tailpiece, Schlage C Keyway 2 Keys, Standard Keyed Different (KD). Other Keying Services are available.	E09221

STANDARD CYLINDER

Illustration	Item Code	Description	ANSI
	CYKB1146SC	Standard Cylinder in Lever, 6 Pin Schlage C Keyway	E09231

SMALL FORMAT INTERCHANGEABLE CORE (SFIC) HOUSING WITH TAILPIECE

Illustration	Item Code	Description	ANSI
	CRZ1126-SFIC-HUS	Housing with Tailpiece	E09261

INTERCHANGEABLE CORES ONLY

- Solid brass plug and housing
- Small Format (SFIC) Core in Best A Keyway
- 6 or 7 pin cores replace Arrow, Best, Falcon
- Construction or Combined Core
- 1 Control key per group/order
- 2 Change keys per Combined Core – A2 System Only
- 1 Master Key or Grand Master key per group/order
- US26D finish only

Illustration	Item Code	Description	ANSI
	CMB-ICBA6-CST	SFIC Core Only, Best A Keyway, 6 Pin, Construction	E09251
	CMB-ICBA6-CMB	SFIC Core Only, Best A Keyway, 6 Pin, Combined	E09251
	CMB-ICBA7-CMB	SFIC Core Only, Best A Keyway, 7 Pin, Combined	E09251

KEYS

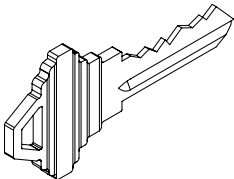
Illustration	Item Code	Description
	LSK-6SC-NP	Standard Key, Schlage C Keyway for 6 Pin, Nickel Plated
	LSK01-6SC-NS-DND	DND Nickel Silver Key, Schlage C Keyway for 6 Pin, w/"Do Not Duplicate"
	LSK06-BA-CRK	Extra Control Key for IC Core, Best A Keyway
	LSK06-BA-MK	Extra Master Key for IC Core, Best A Keyway
	LSK06-BA-GMK	Extra Grand Master Key for IC Core, Best A Keyway

KEYING SERVICES

Description	Item No.
Service: Key Cut including Key Blank	SV-KYCT
Service: Keyed Alike (KA)	SV-KA
Service: Keyed Alike Pair	SV-KA2
Service: Keyed Alike Group (Specify Number of Keyed Alike Per Group)	SV-KA (Number)
Service: Keyed to Specific Code	SV-KS
Service: Master Keying	SV-MK
Service: Grand Master Keying with 2 or more Master groups.	SV-GMK
Service: Construction Master Keying Service	SV-CMK
Service: Great Grand Master Key	SV-GGMK

Description	Item No.
Service: IC Core Key Cut including Key Blank	SV-ICKYCT
Service: IC Core Keyed Alike (KA) - Each cylinder in the group is keyed alike	SV-ICKA
Service: IC Core Keyed to Specific Code - Cylinder is keyed to a specific code	SV-ICKS
Service: IC Core Master Keying - 2 Change Keys per Cylinder and 3 Master Keys per MK	SV-ICMK
Service: IC Core Grand Master Keying (2 or more MK groups included)	SV-ICGMK
Service: IC Core Master Keying, 2 Change Keys Per Cyl, and 3 Master Keys per MK Group	SV-ICMK

STRIKE

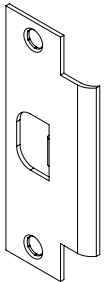

LSR-ASA
ASA Strike (ANSI Standard)
1-1/4"x4-7/8"

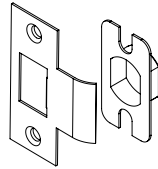

LSR-T1
T- Strike
1-1/8" x 2-3/4"
w/lip 1-1/2"x1/2"

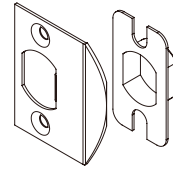

LSR-D1
Full-lip Strike
1-3/4"x2-1/4"

DEADBOLT AND STRIKES

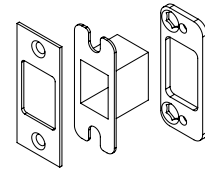
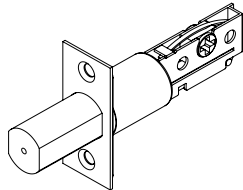

Backset	Grade 1	Grade 2
2-3/8"	BT360F	BT160F
2-3/4"	BT370F	BT170F

Deadbolt Strike 1-1/8" (28mm) x 2-3/4" (70mm) with reinforcement plate, dustbox and 3" (76mm) screws

ELECTRIFICATION OF LOCKS

Description	Item No.
SERVICE CODE: Electrification of Cylindrical Lock, Fail Safe 12V Voltage	SV-CL-EL12V
SERVICE CODE: Electrification of Cylindrical Lock, Fail Safe 24V Voltage	SV-CL-EL24V
SERVICE CODE: Electrification of Cylindrical Lock, Fail Secure 12V Voltage	SV-CL-EU12V
SERVICE CODE: Electrification of Cylindrical Lock, Fail Secure 24V Voltage	SV-CL-EU24V
SERVICE CODE: Electrification of Cylindrical Lock, Fail Safe 12V Voltage with REX Switch	SV-CL-EL12V-REX
SERVICE CODE: Electrification of Cylindrical Lock, Fail Safe 24V Voltage with REX Switch	SV-CL-EL24V-REX
SERVICE CODE: Electrification of Cylindrical Lock, Fail Secure 12V Voltage with REX Switch	SV-CL-EU12V-REX
SERVICE CODE: Electrification of Cylindrical Lock, Fail Secure 24V Voltage with REX Switch	SV-CL-EU24V-REX

Add service code and upcharge price as a separate line item to order electrified locking (EL) locks. In case of power outage, EL locks are Fall Safe and EU locks are Fail Secure.

INOX CL Cylindrical Lock CROSS REFERENCES

ANSI No. Grade 1	Function	INOX®	Dorma	Schlage	Hager	Cal-Royal
F75	Passage	CL10	CL710	ND10S	3410	GN-30
F76	Privacy	CL40	CL840	ND40S	3440	CGN-20
F111	Exit/Communicating	CL25	-	ND25	-	-
F109	Entrance	CL53	CL853	ND53PD	3453	CGN-00
F84	Classroom	CL70	CL870	ND70PD	3470	CGN-03
F110	Intruder Classroom	CL75	-	-	3495	CGN-07
F86	Storeroom	CL80	CL880	ND80PD	3480	CGN-04
F91	Store Door	CL66	-	ND66	-	CGN-02
F87	Institution	CL82	CL882	ND82PD	-	CGN-09
-	Dummy	CL17	CL801	ND170	3417	GN-40

INOX BL Cylindrical Lock CROSS REFERENCES

ANSI No. Grade 2	Function	INOX®	Dorma	Schlage	Hager	PDQ	Cal-Royal
F75	Passage	BL--10	CL710	AL10S	3510	SP126	CSL-30
F76	Privacy	BL--40	CL740	AL40S	3540	SP176	CSL-20
F109	Entrance	BL--53	CL753	AL53PD	3553	SP116	CSL-00
F84	Classroom	BL--70	CL770	AL70PD	3570	SP148	CSL-03
F86	Storeroom	BL--80	CL780	AL80PD	3580	SP115	CSL-04
-	Exit	BL--25	CL725	AL25PD	-	-	CSL-04
-	Dummy	BL--17	CL701	AL170PD	3417	SP211	CSL-40

INOX CX Grade 1 Deadbolt CROSS REFERENCES

ANSI Ref.	Function	INOX®	Dorma	Schlage	Hager	Cal-Royal
E2151	Single Cylinder	CX660	D860	B660P	3115	CRB800
E2161	Cylinder Only x Blank Plate	CX661	D861	B661P	-	-
E2141	Double Cylinder	CX662	D862	B662P	3114	CRB700
E2171	Classroom	CX663	D863	B663P	3118	CRB600
E2191	Door Bolt	CX680	-	B680	-	-

INOX BX Grade 2 Deadbolt CROSS REFERENCES

ANSI Ref.	Function	INOX®	Dorma	Schlage	Hager	Cal-Royal
E0152	Single Cylinder	BX660	D660	B560P	3215	ULT360
E0142	Double Cylinder	BX662	D662	B562P	3214	ULT362
E0192	Door Bolt	BX680	-	B580	-	ULID365



Please visit our website
www.inoxproducts.com
for more technical and new product information.

Unison Hardware, Inc.
6 Wayne Court, Sacramento, CA 95829, USA Tel: +1.916.388.1888 Fax: +1.916.388.8322
Email: info@unisonhardware.com