

TUBULAR & MORTISE Entrance Handlesets



NY/MH/ME/BW TRIM

CONTENTS

Page 01	Escutcheon Plates
Page 02	Lever Designs and Finishes (For Inside Handleset)
Page 03	Tubular Handlesets
Page 06	Mortise Handlesets
Page 07	Mortise Lockcase & Dimensions
Page 08	Lockcase, Faceplate, Strikes, Cylinders, Keying Services
Page 09	Exploded Diagrams
Page 11	How to Order

Disclaimer: All information in this catalog has been deemed accurate as of the date of printing. We are continuously improving and expanding our line in an effort to offer our clients the finest quality products and services; therefore, Unison Hardware, Inc., reserves the right to alter this information or correct printing errors at any time.

©2023 Unison Hardware, Inc. All Rights Reserved.V20230501

TUBULAR ESCUTCHEON PLATES



NY Outside Plate **MH** Outside Plate **SF** Inside Plate

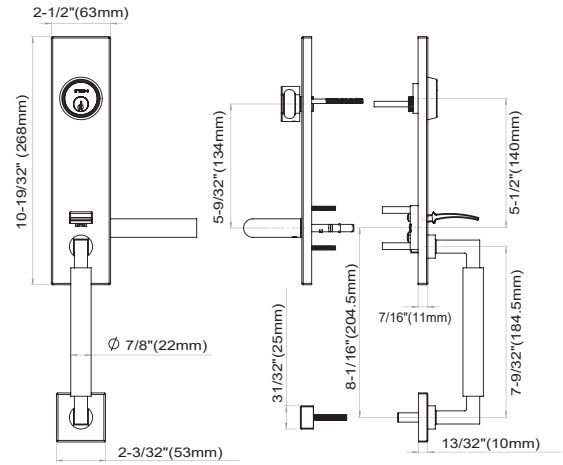

MORTISE ESCUTCHEON PLATES



NY Outside Plate **MH** Outside Plate **SF** Inside Plate

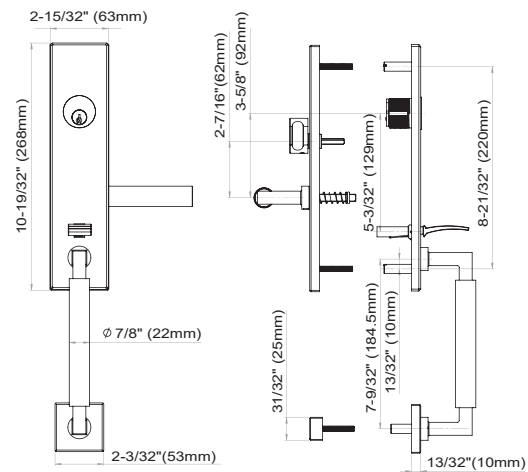

ME Outside Plate **BW** Outside Plate **SF** Inside Plate

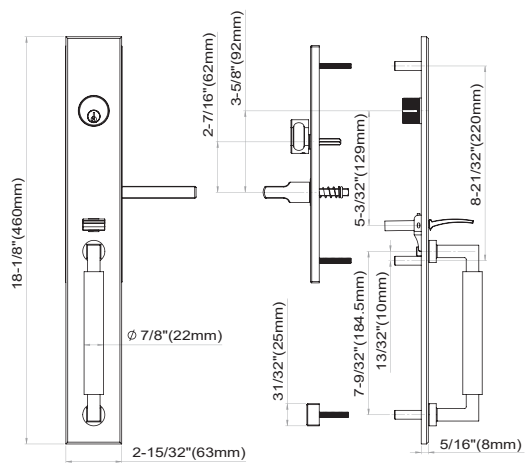

ENTRANCE HANDLESETS

LEVER DESIGNS AND FINISHES (FOR INSIDE HANDLESET)



101 Cologne
(32, 32D)



103 Oslo
(32, 32D)



104 Brussels
(32, 32D)



105 Frankfurt
(32, 32D, 19G, 10B)



106 Copenhagen
(32, 32D, 10B)



107 Stockholm
(32, 32D)



108 Vienna
(SP*, PVD4)



210 Air-stream
(32, 32D, 10B)



211 Breeze
(32, 32D, 10B)



213 Cabernet
(32, 32D)



214 Champagne
(32, 32D, 10B)



217 Horizon
(32, 32D)



221 Aurora
(32, 32D, SP, 19G, 10B)



223 Phoenix
(32D, SP*)



225 Waterfall
(32, 32D)



226 Summer
(32, 32D)



227 Stratus
(32, 32D)



243 Sunrise
(32, 32D, 10B, 19G, PVD4)



251 Sequoia
(32, 32D, SP*)



276 Plaza
(32, 32D, 19G, PVD4)



300 Napa
(32, 32D, 19G)



311 Crest
(32, 32D, 10B)



318 Café
(32, 32D, 19G, 10B)

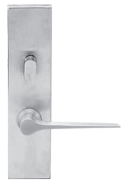

319 Hampton
(32, 32D, 19G)



320 Empire
(32, 32D, 19G)



344 Ecco
(32, 32D)



345 Tokyo
(32, 32D, 19G, 10B)



351 Toronto
(32, 32D)

Lever Designs with "Return To Door" (RTD)

Compliant with California Fire Code



379 Arctic
(32, 32D)



380 Polaris
(32, 32D)



102 Munich
(32, 32D)



109 Stuttgart
(32, 32D)



244 Twilight
(32, 32D)



321 Valencia
(32, 32D, 19G)



346 Osaka
(32, 32D)

*SP is a two-tone stainless steel finish: satin (32D) finish on lever grip, polished (32) finish on lever neck and roses.

TUBULAR HANDLESETS



SPECIFICATIONS

Door Thickness	1-3/4" (44mm) standard Thick Door Kits available
Backset	2-3/8" (60mm) standard 2-3/4" (70mm) optional
Handing	Handing specification required Latchbolt is field reversible
Center Distance	Lever to Cylinder 5-1/2" (140mm)
Cylinder & Keys	5-pin Schlage C keyway with 2 keys
Leverset Thru-bolts	2 EA M4x35mm
Deadbolt Thru-bolts	2 EA M5x50mm

STANDARD FINISHES

- 32D Satin Stainless Steel
- 32 Bright Stainless Steel
- 10B Oil Rubbed Bronze (Limited Styles available)
- 19G Graphite Black (Limited Styles available)
- PVD4 Satin Brass (Limited Styles available)
- SP Split Finish (Limited Styles available)
- CeraMax Ceramic Coating: C19G Graphite Black, C19 Flat Black, CGY Stormy Grey, CDB Dark Bronze

For additional finish options not listed, contact Sales Department for MOQ and lead times

FUNCTION

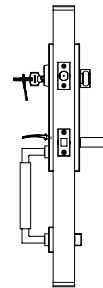

Entrance (C563/C573)

Deadbolt is locked or unlocked by key outside or thumbturn inside. Thumb-piece from outside or lever from inside retracts latchbolt. Deadbolt and latch are not interconnected.

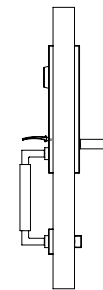

Entry Dummy (TDP)

NY/ MH trim with rim dummy cylinder outside, dummy plate escutcheon inside.

ENTRANCE HANDLESETS

TUBULAR LATCH

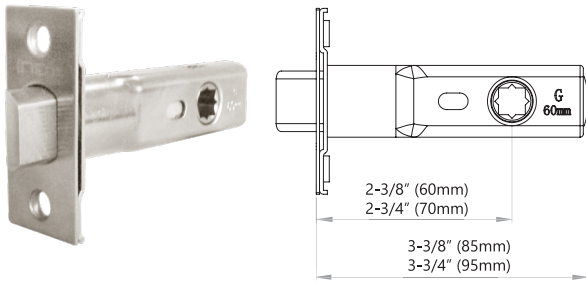

TL5 – Residential Grade
 28° Degree Latch Retraction
 Backset: 2-3/8" (60mm), 2-3/4" (70mm)
 Function: Passage (For Tubular Handlesets Only)
 Faceplate: 1" x 2-1/4"

Backset	Function	Item Code
2-3/8" (60mm)	Passage	TL561
2-3/4" (70mm)	Passage	TL571

STRIKES

All latches come with both T-Strike and Full-lip Strike with square corners. Full-lip Strike with Radius Corner and ASA Strike can be ordered separately.

Full-lip Strike
LSR-D1
 1-3/4"x2-1/4"

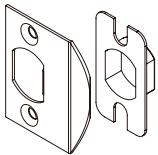

Full-lip Strike 1/4" Corner
LSR-D14
 1-3/4"x2-1/4"

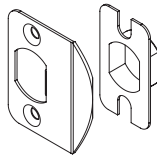

T- Strike
LSR-T1
 1-1/8" x 2-3/4"
 w/lip 1-1/2"x1/2"

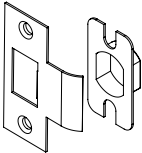

ASA Strike (ANSI Standard)
LSR-ASA
 1-1/4"x4-7/8"

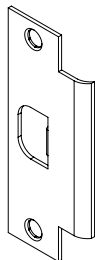

CHANGE LATCH BOLT DIRECTION FOR TL5 LATCH

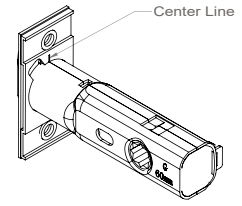
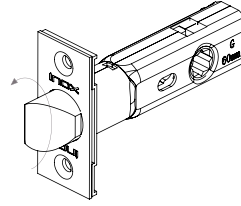

Change the latch direction 180° with the faceplate together.
 Note: Be sure to install the latch with faceplate attached to the latch body

Note: Please ensure the center line on the back of the faceplate meets the center seam of the latch case

GEAR DRIVE

Slim Gear Drive design fits perfectly in INOX Entrance Handleset Escutcheons

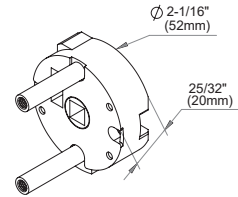

SPINDLE FOR TUBULAR LATCH TL5 AND GEAR DRIVE

FC-SW8875

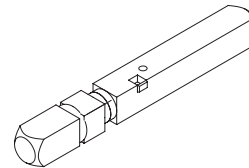

DEADBOLT

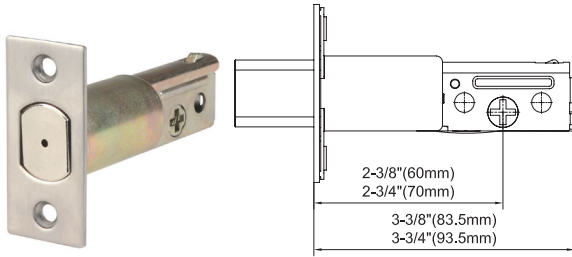

Backset	2-3/8" (60mm), 2-3/4" (70mm)
Deadbolt	1" (25mm) throw with anti-drill pin
Function	Suitable for entry door or doors needing to be locked
Faceplate	2-1/4" x 1"
Cylinder & Keys	5-pin Schlage C keyway cylinder with 2 keys

Backset	Item No.
2-3/8"	BT160
2-3/4"	BT170
3 Hour Fire-Rated	
2-3/8"	BT160F
2-3/4"	BT170F

DEADBOLT STRIKE AND FACEPLATE

Deadbolt Faceplate

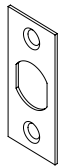

BT1-FSP

Deadbolt Strike w/ reinforcement plate and dustbox

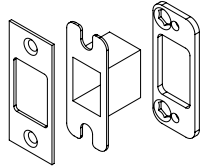

LSR-BT1

RIM CYLINDERS

Schlage C Keyway, 5 Pin, with Tailpiece, 2 Keys.
Standard Keyed Different (KD).
Other Keying Services Available.

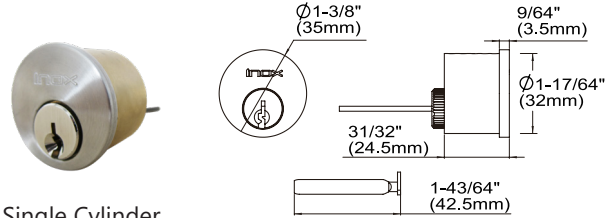

Single Cylinder
CRB105



Dummy Cylinder
CRA10D



Thumbturn
TT04C

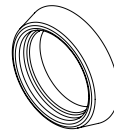

Cylinder Escutcheon
EC-R460COL

MORTISE HANDLESETS



SPECIFICATIONS

Door Thickness	1-3/4" (44mm) standard Thick Door Kits available
Backset	MT620: 2-1/2" (63.5mm) Standard MT720: 2-3/4" (70mm) Optional
Lockcase	Field reversible without disassembly
Handing	Handing specification required
Center Distance	Lever to Cylinder 3-5/8" (92mm) Lever to Thumbturn 2-7/16" (62mm) Keying service available
Cylinder & Keys	6-pin Schlage C Keyway Cylinder with 2 keys
Standard Cylinder Size for 1-3/4" Door	NY/MH Trim: 1-1/4" Cylinder ME/BW Trim: 1-1/8" Cylinder

STANDARD FINISHES

- 32D Satin Stainless Steel
- 32 Bright Stainless Steel
- 10B Oil Rubbed Bronze (Limited Styles available)
- 19G Graphite Black (Limited Styles available)
- PVD4 Satin Brass (Limited Styles available)
- SP Split Finish (Limited Styles available)
- CeraMax Ceramic Coating: C19G Graphite Black, C19 Flat Black, CGY Stormy Grey, CDB Dark Bronze

For additional finish options not listed, contact Sales Department for MOQ and lead times

FUNCTION

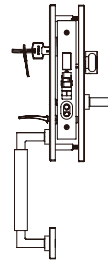

Entrance (MT620/MT720)

Key from outside locks and unlocks deadbolt.
Thumb-piece from outside retracts latchbolt. Thumbturn from inside locks and unlocks deadbolt.
Inside lever is always unlocked allowing emergency egress.
Toggle always in locked position unless set to unlock manually.
Locking deadbolt by thumbturn or key resets toggle to locked position.

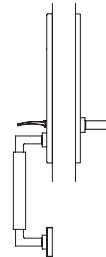

Entry Dummy (MTEDP)

NY/MH/ME/BW trim with dummy cylinder outside, dummy plate escutcheons inside.

MORTISE LOCKCASE & DIMENSIONS

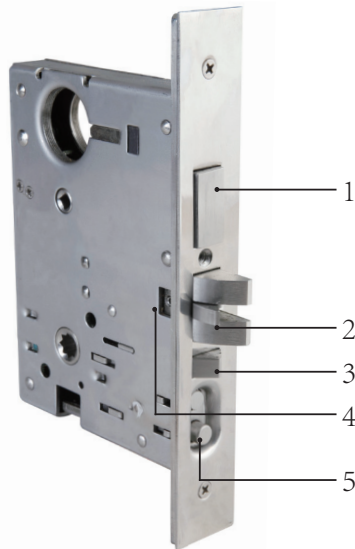

MT Cam
CAM04-MT

1. 1" throw, heavy duty stainless steel deadbolt
2. Guarded, two-piece stainless steel 3/4" latch bolt projection with mechanical anti-friction tongue
3. Auxiliary latch deadlocks latch bolt when door is closed, providing extra security
4. Field reversible: latch direction can be easily reversed without opening lock case
5. When toggle switch is locked, outside lever is inoperative; when toggle switch is unlocked, outside lever is operative

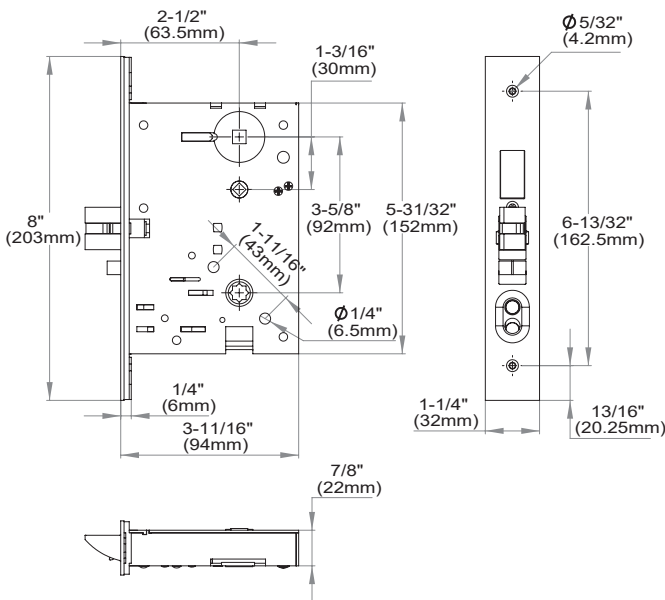

MT620 Mortise Lock Dimensions

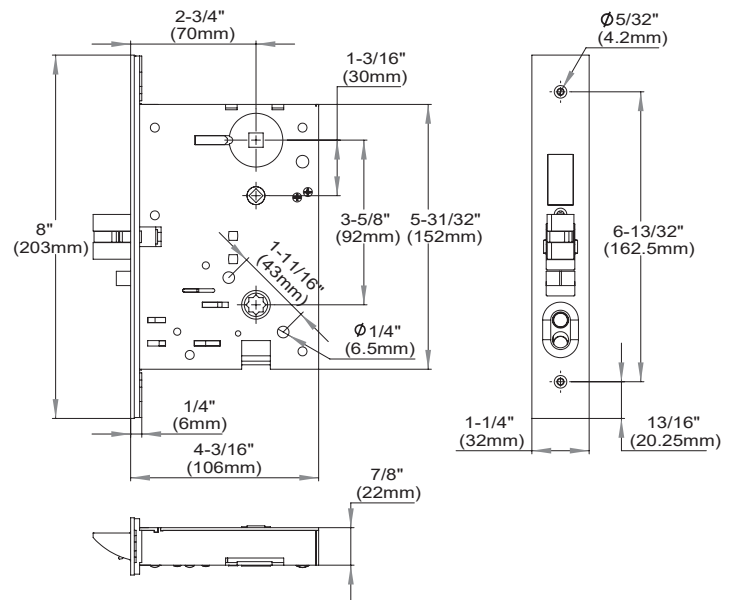

MT720 Mortise Lock Dimensions

ENTRANCE HANDLESETS

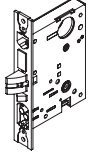

MT MORTISE LOCKCASE

For all Mortise Handlesets only
w/faceplate, strike and dustbox (less cylinder)

Illustration	Backset	Function	Item Code
	2-1/2"	Entry w/ Toggle	MT620- 32D/32/10B
	2-3/4"	Entry w/ Toggle	MT720- 32D/32/10B

* MT Lock built-in toggle buttons are set to be locked by default, which deactivates the outside thumb-piece. This allows door to be kept locked even without using key or thumbturn to engage deadbolt. Toggle can be manually set to unlocked position, in which case the outside thumb-piece will engage the latch bolt and act as a passage latch until the toggle is reset to locked position, either manually or set automatically by using thumbturn or key.

MT MORTISE FACEPLATE AND STRIKE

Illustration	Function	Item Code
	MT Mortise Faceplate	MT-FSP20- 32D/32/10B
	MT Mortise Strike	LSR-MT01- 32D/32/10B
	MT Mortise Strike Dust Box	LSR-DBX-MT

KEYING SERVICES

Description	Item No.
Service: Key Cut including Key Blank	SV-KYCT
Service: Keyed Alike (KA)	SV-KA
Service: Keyed to Specific Code	SV-KS
Service: Master Keying	SV-MK
Service: Grand Master Keying with 2 or more Master groups.	SV-GMK
Service: Construction Master Keying Service	SV-CMK

MORTISE CYLINDERS AND KEYS

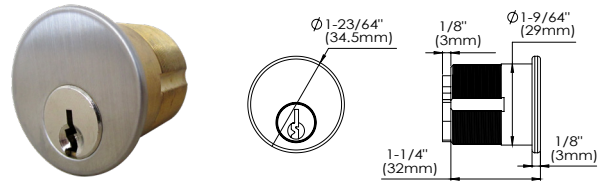

Schlage C Keyway, 6 Pin, with Clover Cam, 2 Keys. Standard Keyed Differ (KD). Other Keying Service available.
Standard Cylinder Size for 1-3/4" Door:
NY and MH Trim: 1-1/4" Mortise Cylinder
ME and BW Trim: 1-1/8" Mortise Cylinder
Please refer to Price Book for details of Thick Door Kits (TDK)

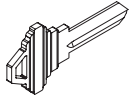
Product Illustration	Description	Item No.
	1-1/8" Mortise cylinder with MT cam	CMB1186 CAM04-MT
	1-1/4" Mortise cylinder with MT cam	CMB1146 CAM04-MT
	1-3/8" Mortise cylinder with MT cam	CMB1386 CAM04-MT
	1-1/2" Mortise cylinder with MT cam	CMB1126 CAM04-MT
	1-5/8" Mortise cylinder with MT cam	CMB1586 CAM04-MT
	1-3/4" Mortise cylinder with MT cam	CMB1346 CAM04-MT
	Key blanks Schlage C Keyway 6 pin for Mortise Cylinder	LSK01-6SC- NP

EXPLODED DIAGRAMS

NY TUBULAR ENTRANCE

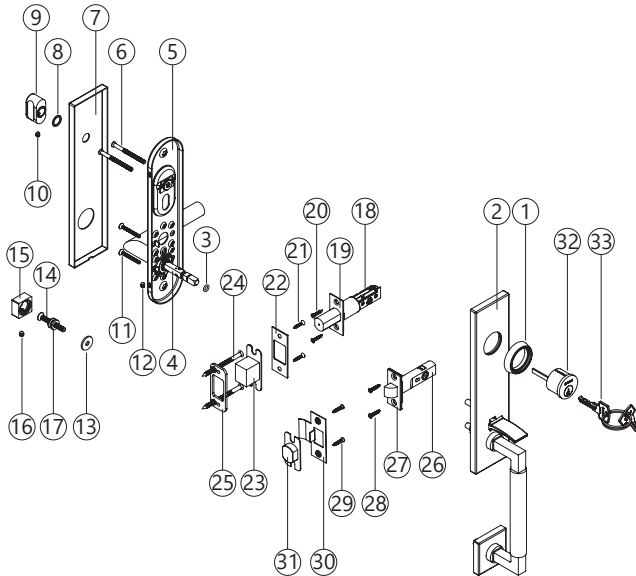

- | | |
|-------------------------------|---|
| 1. Cylinder Escutcheon | 18. Deadbolt |
| 2. Outside Plate | 19. Deadbolt Faceplate |
| 3. Rubber Ring | 20. Deadbolt Faceplate Screws |
| 4. Tubular Spindle 8mm Square | 21. Deadbolt Strike Screw |
| 5. Inside Sub-plate | 22. Deadbolt Strike |
| 6. Thru-bolt for Cylinder | 23. Deadbolt Dust Box |
| 7. Inside Cover Plate | 24. Deadbolt Reinforcement Plate Screws |
| 8. Thumbturn Washer | 25. Deadbolt Reinforcement |
| 9. Thumbturn | 26. Tubular Latch |
| 10. Thumbturn Set Screw | 27. Tubular Latch Faceplate |
| 11. Thru-bolt for Sub-plate | 28. Tubular Latch Faceplate Screws |
| 12. Set Screw for Lever | 29. Tubular Latch Strike Screw |
| 13. Thru-bolt Washer | 30. Tubular Latch Strike |
| 14. Handgrip Thru-bolt | 31. Tubular Latch Dust Box |
| 15. Thru-bolt Cap | 32. Rim Cylinder |
| 16. Thru-bolt Cap Set Screw | 33. Keys |
| 17. Thru-bolt Adaptor | |

NY MORTISE ENTRANCE

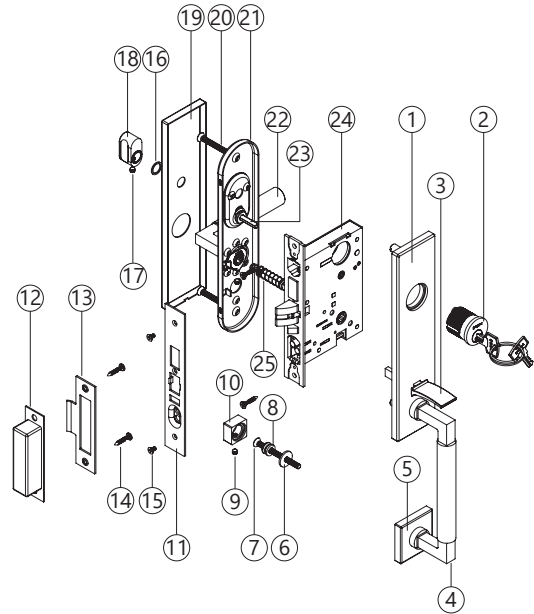

- | | |
|-------------------------------|---------------------------------|
| 1. Outside Plate | 14. Strike Screws |
| 2. Mortise Cylinder | 15. Faceplate Screws |
| 3. Thumb-piece | 16. Thumbturn Washer |
| 4. Handgrip | 17. Thumbturn Set Screw |
| 5. Handgrip Lower Escutcheon | 18. Thumbturn |
| 6. Thru-bolt Washer | 19. Inside Cover Plate |
| 7. Handgrip Thru-bolt | 20. Thru-bolt for Sub-plate |
| 8. Thru-bolt Adaptor | 21. Inside Sub-plate |
| 9. Thru-bolt Cap Set Screws | 22. Inside Lever |
| 10. Thru-bolt Cap | 23. Deadbolt Spindle 5mm Square |
| 11. MT Mortise Lock Faceplate | 24. MT Mortise Lock Case |
| 12. Dust-box | 25. Lever Spindle 8mm Square |
| 13. MT Mortise Lock Strike | |

EXPLODED DIAGRAMS

NY TUBULAR ENTRY DUMMY

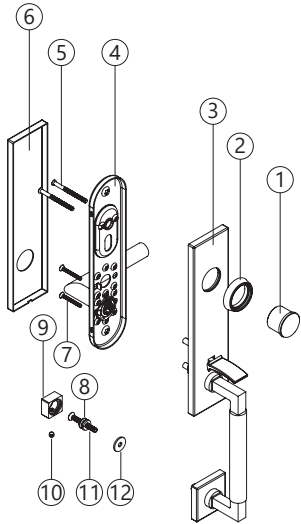

1. Rim Dummy Cylinder
2. Cylinder Escutcheon
3. Outside Plate
4. Inside Sub-plate
5. Thru-bolt for Dummy Cylinder
6. Inside Cover Plate
7. Thru-bolt for Sub-plate
8. Thru-bolt Adaptor
9. Thru-bolt Cap
10. Thru-bolt Cap Set Screw
11. Handgrip Thru-bolt
12. Thru-bolt Washer

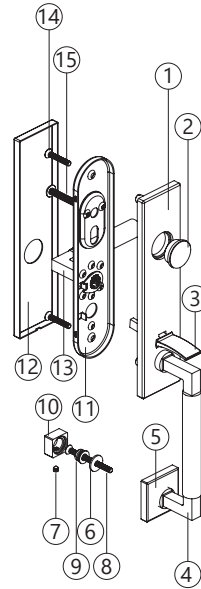

NY MORTISE ENTRY DUMMY



1. Outside Plate
2. Dummy Cylinder
3. Thumb-piece
4. Handgrip
5. Handgrip Lower Escutcheon
6. Thru-bolt Washer
7. Thru-bolt Cap Set Screw
8. Handgrip Thru-bolt
9. Thru-bolt adaptor
10. Thru-bolt Cap
11. Inside Sub-plate
12. Inside Cover Plate
13. Inside Lever
14. Thru-bolt for Sub-plate
15. Thru-bolt for Dummy Cylinder

HOW TO ORDER Handleset for Swing Doors

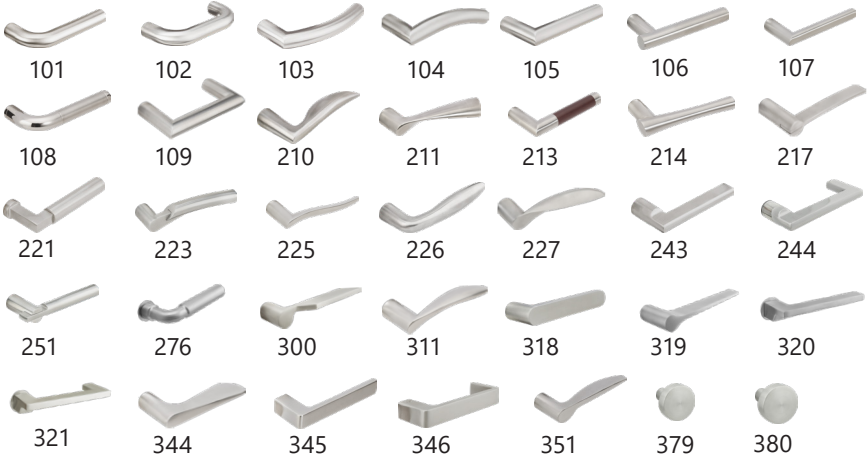
To order locksets, please describe the additional requirements in the same sequence as below. Please see price book for parts or additional service upcharge.

Plate	Lever	Function	Finish	Handing
NY ①	318 ②	MT620 ③	-32D ④	-LH ⑤
PLATE	LEVER			
 NY MH				
 ME BW				

③ FUNCTION

- C563 Tubular Entry Handleset, 2-3/8" Backset
- C573 Tubular Entry Handleset, 2-3/4" Backset
- TDP Tubular Entry Dummy Set with Dummy Cylinder

- MT620 Mortise, Keyed Entry, 2-1/2" Backset
- MT720 Mortise, Keyed Entry, 2-3/4" Backset
- MTEDP Mortise Entry Dummy Set with Dummy Cylinder

④ FINISH

Standard:

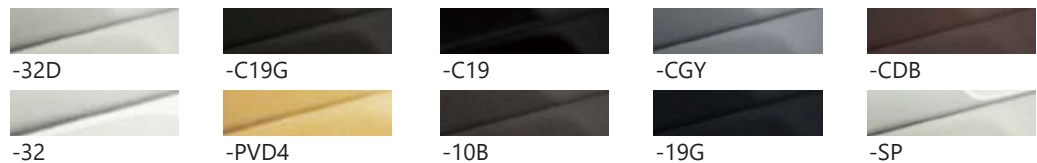

⑤ HANDING

- RH = Right Hand
- LH = Left Hand
- RHR = Right Hand Reverse
- LHR = Left Hand Reverse

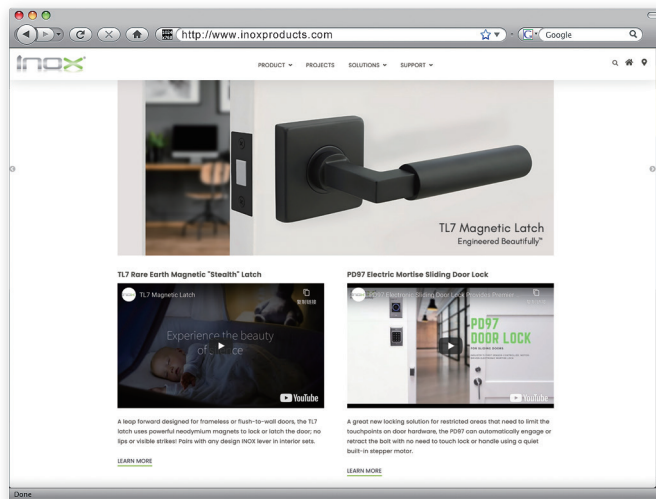

Please visit our website
www.inoxproducts.com
for more technical and new product information.

Unison Hardware, Inc.
6 Wayne Court, Sacramento, CA 95829, USA Tel: +1.916.388.1888
Email: info@unisonhardware.com