



PD97ES

Electrified Mortise Locks with Auto-locking & Monitoring for Sliding Doors

- Motor Driven 12/24V electrified lock for sliding doors
- Built-in DPS & DBM sensors, enabling auto-latching and auto-locking functions
- Supports touchless opening solutions when paired with an auto-operator
- Fail Secure lock remains mechanically locked during power failure, ensuring security
- Designed for easy integration with access control and monitoring systems

SPECIFICATIONS

Door Thickness	1-3/4" (45mm) Standard
	1-3/8" (35mm) Thin Door Kit available for XGT only
	2" to 2-1/4" (50mm to 57mm) Thick Door Kit available
Backset	2-3/4" (70mm) 2-1/2" (63.5mm)
Lever Spindle	8 x 8mm square
Thumbturn Spindle	5 x 5mm square
Center to Center Distance	Lever to Cylinder: 3-7/8" (98mm)
	Lever to Thumbturn: 2-11/16" (68mm)
Handing	Specify handing when ordering
Cylinder	Schlage C keyway 6 pin, 1-1/4" mortise cylinder with 2 keys (standard). Optional SFIC and LFIC housing and cores available
CAM	CAM01-SCL Clover Cam
Material	Trim: Stainless Steel
	Lockcase: Heavy gauge Steel
	Bolt: Brass and Stainless Steel
	Faceplate/Strike: Stainless Steel
	Cylinder: Solid Brass

ELECTRICAL SPECIFICATIONS

Lock Body	≤560 mA
Strike	≤40 mA
Keypad	≤90mA
Handwave	≤30 mA
Relay	≤30 mA
Monitor	≤30 mA



CODE COMPLIANCE

- UL1034 Burglary-Resistant Electric Locking Mechanisms
- UL294 Standard for Access Control System Units
- ANSI/BHMA A156.25 Electrified Mortise Locks
- ANSI/BHMA A156.18 Finishes
- ANSI A117.1 ADA Accessibility

FINISH

- 32D Satin Stainless Steel
- 32 Bright Stainless Steel
- PVD4 Satin Brass (243 and 276 levers)
- CeraMax Ceramic Coating: C19G Graphite Black, C19 Flat Black, CGY Stormy Grey, CDB Dark Bronze
- Please see Finish Solutions on INOX Website for special order finishes

PD97ES ELECTRIFIED SLIDING DOOR MORTISE LOCK

FUNCTION

PD97ES Functions are **Fail Secure**. Deadbolt auto-locks once door is closed; during power failure, deadbolt remains mechanically locked from outside.

PD97ES includes the following monitoring sensors:

- REX = Request-to-Exit Monitoring Switch
- DBM = Deadbolt Monitoring Switch
- DPS = Door Position Switch

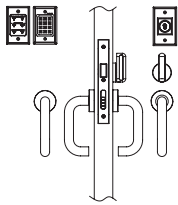

Patio/Exit 60

- Deadbolt projected/retracted by built-in stepper motor when energized by 12/24V DC power transferred through contacts on lock and strike
- Thumbturn inside throws/retracts deadbolt to lock/unlock door
- Outside lever is rigid at all times
- Inside lever always unlocks deadbolt for emergency egress

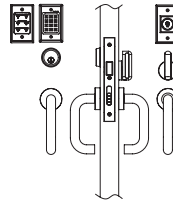

Entrance 53

- Latchbolt projected/retracted by built-in stepper motor when energized by 12/24V DC power transferred through contacts on lock and strike
- Key from outside to throw/retract latchbolt to lock/unlock door
- Thumbturn inside throws/retracts latchbolt to lock/unlock door
- Outside lever is rigid at all times
- Inside lever always unlocks latchbolt for emergency egress

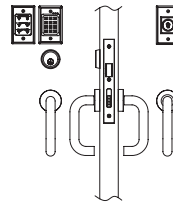

Storeroom 80

- Latchbolt projected/retracted by built-in stepper motor when energized by 12/24V DC power transferred through contacts on lock and strike
- Key from outside to throw/retract latchbolt to lock/unlock door
- Door cannot be locked from inside
- Outside lever is rigid at all times
- Inside lever always unlocks latchbolt for emergency egress

FUNCTION TABLE

	Entrance	Storeroom	Patio/Exit
Outside Lever	✓	✓	✓
Inside Lever	✓	✓	✓
Lockcase	✓	✓	✓
Cylinder	✓	✓	✗
Inside Thumbturn	✓	✗	✓
Optional Accessories			
Switch	✓	✓	✓
Power Supply	✓	✓	✓
Keypad w/Built-in Relay	✓	✓	✓
Push Button	✓	✓	✓
Handwave	✓	✓	✓

PD97ES ELECTRIFIED SLIDING DOOR MORTISE LOCK

COMPONENTS

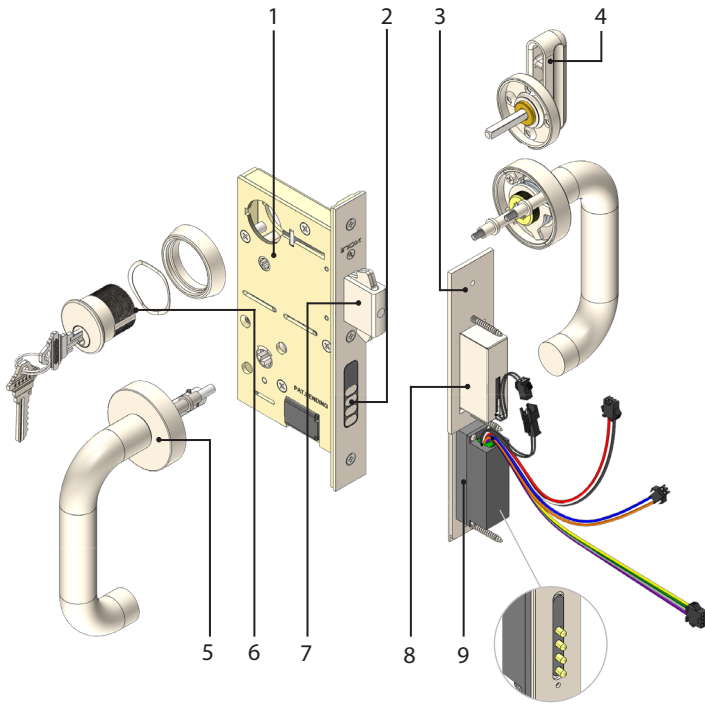

Description

- 1 PD97ES lockcase and faceplate; 2-3/4" backset **PD97ES-234** or 2-1/2" backset **PD97ES-212**
- 2 Faceplate contacts; Auto-locking, DPS (Door Positioning Switches), Power Transfer
- 3 Strike with reinforcement plate for door frame
- 4 **TT07-ADA** ADA Compliant thumbturn
- 5 Heavy-duty Stainless Steel cast rose with choice of X Series lever design
- 6 Schlage C keyway, 6 pin 1-1/4" mortise cylinder **CMB1146**
- 7 1" (25.4mm) heavy-duty brass bolt throw with self-retracting non-marring hooks
- 8 Dust box with DBM (Deadbolt Monitoring Sensor)
- 9 Power Transfer Strike with spring-loaded prongs **PD97ES-ADJ-STRK** 6-9/16"x1"x3/16"

Optional INOX Access Control Accessories

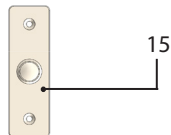
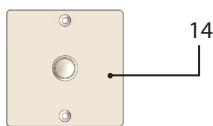
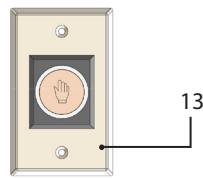
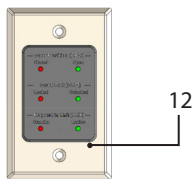
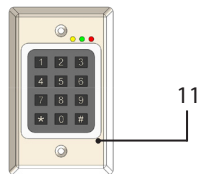

Optional Accessories, use the part numbers below as new line items.

- 10 **ELPS5-4** Power Supply with built-in surge protection, Voltage: 2A@12/24V DC, Dimension: 11"x11"x4"
- 11 **AC-KP1200** Stainless Steel keypad faceplate for indoor electrically locked door application, Voltage: 12/24V DC, Dimension: 4-1/2" x2-3/4" x1-1/4"
- 12 **AC-MP100** Stainless Steel Monitoring Panel Dimension: 4-1/2" x2-3/4" x3/4"
- 13 **AC-IR1100** Handwave sensor with illuminated display, Voltage: 2A@12/24V DC, Dimension: 4-1/2" x2-3/4" x1"
- 14 **AC-PB200** Wide Push Button with illuminated display, Dimension: 3-3/8" x3-3/8" x3/4"
- 15 **AC-PB100** Narrow Push Button with no illuminated display, Dimension: 3-1/2" x1-1/8" x1"

NOTE: PD97ES locks only require 3~6 seconds of continuous power to engage or retract deadbolt; time varies subject to soft close or weatherstripping conditions on sliding door. Continuous power longer than required will damage the motor, so make certain that your connected relay has a timed function.

PD97ES ELECTRIFIED SLIDING DOOR MORTISE LOCK

DIMENSIONS

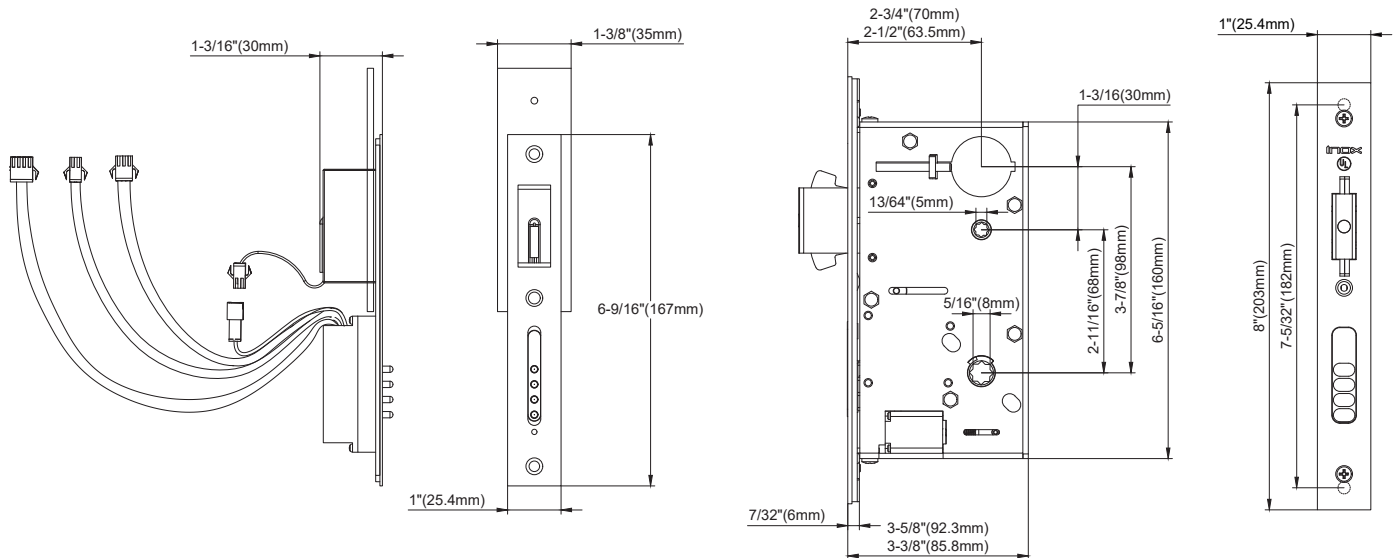

BUILT-IN MONITORING SWITCHES

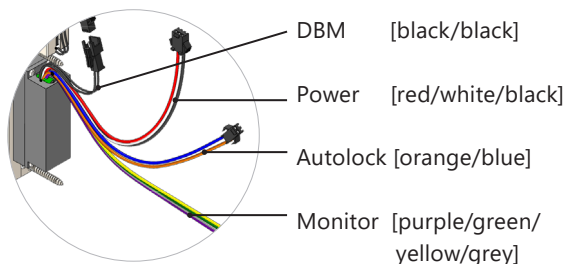
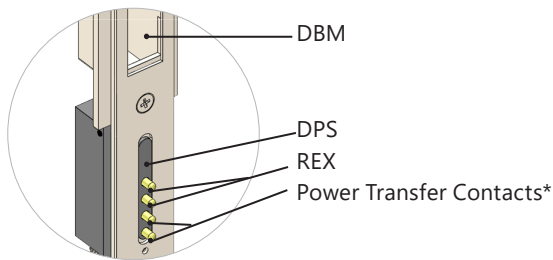
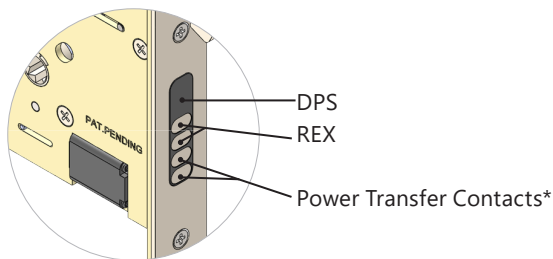

*Power Transfer to the lock occurs on contact with the pogo pins on the strike.

Auto-locking Function [orange/blue]

- When the door is closed, the DPS will send power to the motor for auto-locking.
- When the DBM detects the deadbolt is not fully engaged, the DPS indicates the door is still closed; the auto-locking switch will trigger the power to be sent to the lock for auto-relocking again. If this verification process is repeated 3 times, an alarm sound will be activated unless user re-opens the door.

DPS (Door Position Switch) [yellow/purple]

- Monitoring signal showing the position of the door either as closed or open.
- When door is closed, the DPS signal will trigger an auto-locking switch function.

DBM (Deadbolt Monitoring Switch) [green/purple]

- Monitoring signal showing the position of the deadbolt as locked or unlocked.
- If the deadbolt is not fully engaged in the strike after a locking cycle, the DBM signal will trigger a relocking cycle.
- After 3 failed attempts to lock, an integrated speaker will chime 60 seconds to notify user that the door failed to lock.

REX / Inside Lever Monitoring Switch [grey/purple]

- Monitoring signal alerts that someone is using the lever, intending to exit from within secure area. someone intending to exit from within the secure

PD97ES ELECTRIFIED SLIDING DOOR MORTISE LOCK

WIRING DIAGRAM

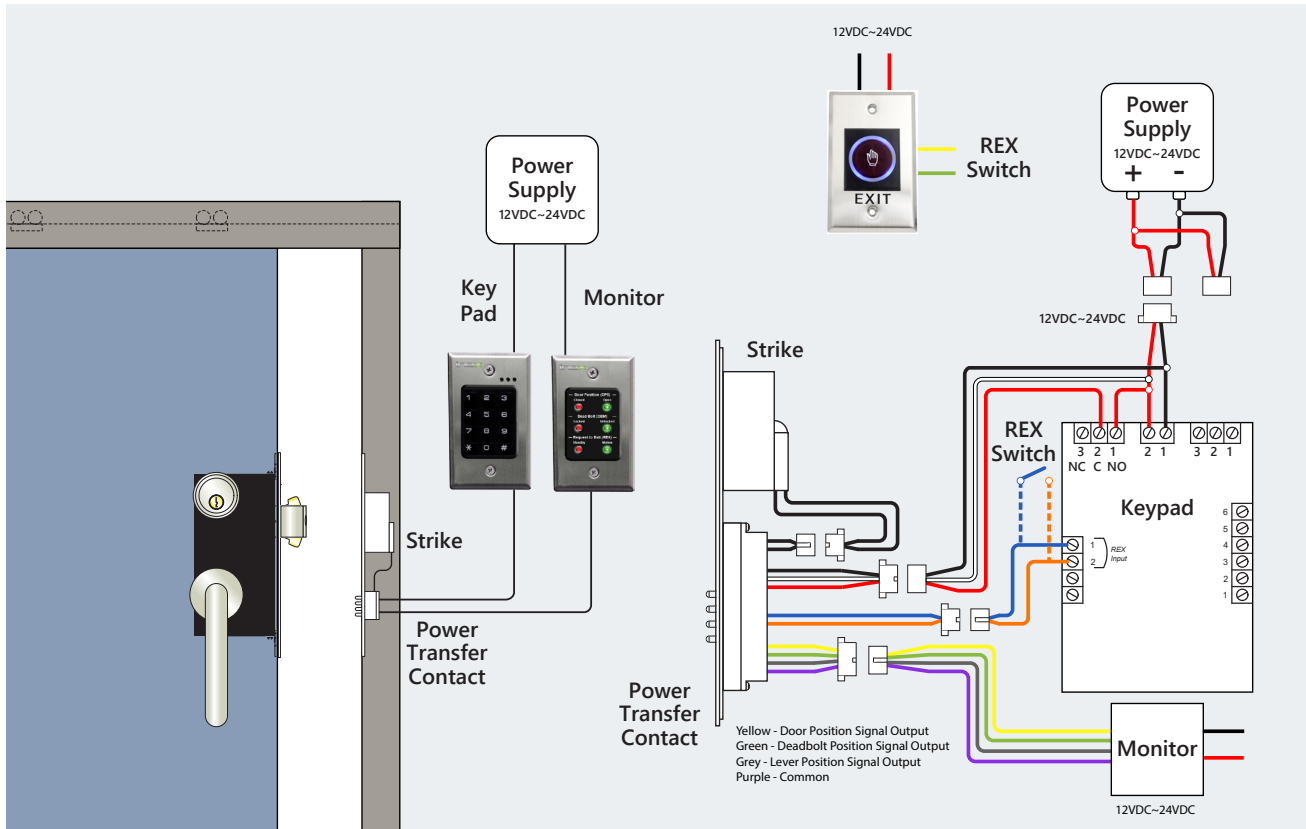

This product for UL compliance shall be used with UL Listed access control and burglar alarm control panels / peripheral devices. Accessories are shown for reference only and not evaluated for UL294 or UL1034.

PD97ES Electrified Locks are designed to operate at 12/24V. Complete INOX system maximum current draw is 780 mA. INOX breakdown of individual items:

Lock Body	≤560mA
Strike	≤40 mA
Keypad	≤90 mA
Handwave	≤30 mA
Relay	≤30 mA
Monitor	≤30 mA

For UL compliance the product is to be powered via a UL294 or UL603 or UL2610 power supply with a class 2 power limited output suitable for the power requirement of the product.

Door Position Switch (DPS), Deadbolt Monitoring Switch (DBM): 250K cycles of operation resistive load.

HANDING

- Handing refers to the direction the door slides open. Example: If the door slides to the left to open, it is a left-handed door.
- Handing is determined from the exterior or key side of the door when facing into the room.

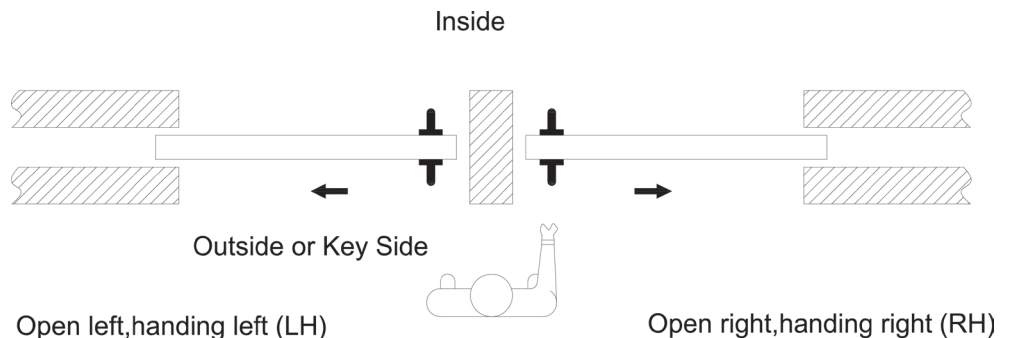

TRIM AND THUMBTURN OPTIONS

ROSE & LEVER DESIGN



XGT Rose



XGS Rose

*Return-to-Door Lever Designs comply with California and other state building codes for door openings



201 COLOGNE



202 MUNICH*



205 FRANKFURT



221 AURORA



243 SUNRISE



244 TWILIGHT*



276 PLAZA



318 CAFE



319 HAMPTON



320 EMPIRE



345 TOKYO



346 OSAKA*

THUMBTURN OPTIONS

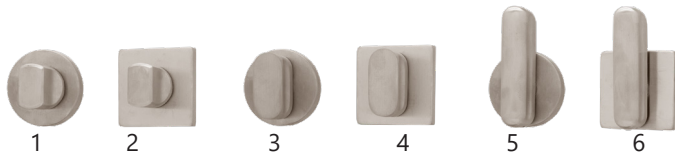

Ref. Description

Part Number

1	TT02 Thumbturn in Round Rosette	EC-R460TT02
2	TT02 Thumbturn in Square Rosette	EC-S420TT02
3	TT04 Thumbturn in Round Rosette	EC-R460TT04
4	TT04 Thumbturn in Square Rosette	EC-S420TT04
5	ADA TT07 Thumbturn in Round Rosette	EC-R460TT07-ADA
6	ADA TT07 Thumbturn in Square Rosette	EC-S420TT07-ADA

PD97ES ELECTRIFIED SLIDING DOOR MORTISE LOCK

ELECTRIFIED LOCKS COMPARISON

Trim	PD97	PD97PT	PD97ATL	PD97ES
X Series Trim	✓	✓	✓	✓
Outside Surface Pull with Inside Lever for Egress	✓	✓	✓	✓
Performance Capabilities				
Touchless Unlocking	✓	✓	✓	✓
Built-in Power Transfer within Lockset	✗	✓	✓	✓
Self-latching/Auto-locking*	✗	✗	✓	✓
Auto-locking with Monitoring Panel	✗	✗	✗	✓
Compliance Certification				
UL294 Safety and Security for Access Control System	✗	✓	✓	✓
UL1784 Air Leakage Test for Draft, Smoke Door Assembly	✗	✗	✓	✓
UL1034 Burglary Resistant Electric Lock Mechanism	✓	✓	✓	✓
ANSI/BHMA A156.25 Electrified Locking Device	✓	✓	✓	✓















* Passage or Office Function only



PD97ES ELECTRIFIED SLIDING DOOR MORTISE LOCK

HOW TO ORDER LOCKSETS

To order locksets, please describe the additional requirements in the same sequence as below. Please see price book for parts or additional service upcharge.

Rose	Lever	Lock	Function	Backset	Thumbturn	Cylinder	Finish	Handing
XGT	243	-PD97ES	53	A	TT04		-32D	-LH
1	2	3	4	5	6	7	8	9
ROSE	LEVER	LOCK			FUNCTION			
 XGT	 XGS	 -PD97ES			53 Entrance 60 Patio/Exit 80 Storeroom			
	 201	 202	 205	 221	 243			
	 244	 276	 318	 319	 320			
	 345	 346						

5 BACKSET

Backset Blank = 2-3/4"

Backset A = 2-1/2"

6 THUMBTURN



GT02



GT04



Blank = TT07

7 CYLINDER AND HOUSING

Blank = Standard Cylinder (CMB1146-FINISH-KD)

-SFIC6 = Small Format Interchangeable Housing 6-Pin (CMB1146-ICBA-HUS-FINISH)

-SFIC7 = Small Format Interchangeable Housing 7-Pin (CMB1387-ICBA-HUS-FINISH)

-LFIC6 = Large Format Interchangeable Housing 6-Pin (CMB1126-LFIC-HUS-FINISH)

(Order IC Cores separately)

8 FINISH

Standard:



-32D



-C19G



-C19



-CGY



-CDB



-32



-PVD4

PVD4 finish available in the 243 and 276 lever design

9 HANDING

-RH = Right Hand

-LH = Left Hand