

Locksets for Entry and Interior Swing Doors

High End Hospitality/Mixed Use & Residential Applications
Mechanical & Electrified

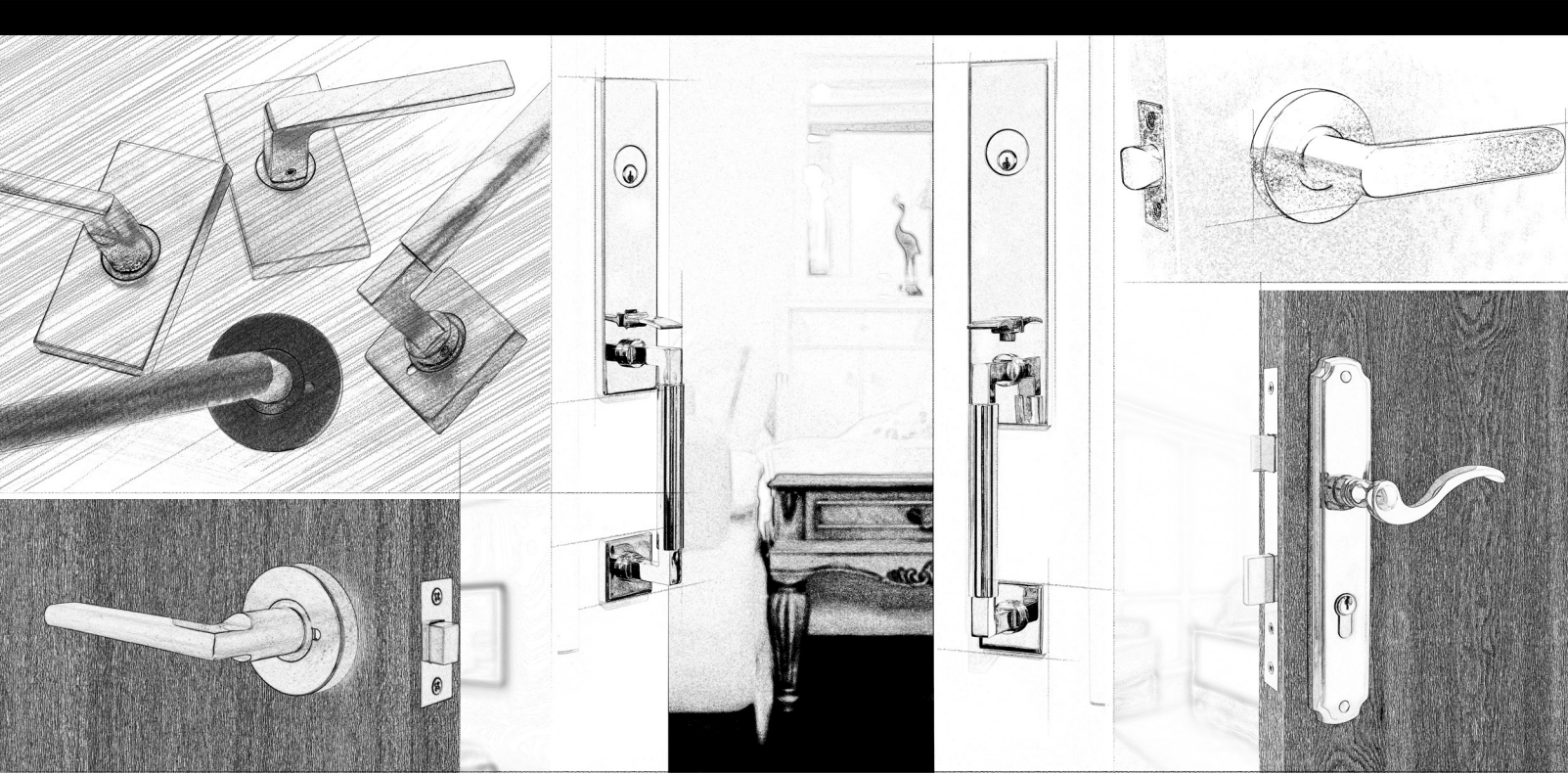

Chapter 1: Mortise Locksets & Mortise Deadbolt

Chapter 2: Cylindrical Locksets

Chapter 3: TL4 Grade 2 Tubular Locksets & TL7 Magnetic Tubular Locksets

Chapter 4: Handlesets

Chapter 5: Universal Multipoint Trim (Summary)

Chapter 6: Privacy Bolts and Deadbolts

Issue #6.3

Effective Date: 28 April 2025 - Updated: 07/17/2025

UNISON HARDWARE INC.

Lever Design Overview

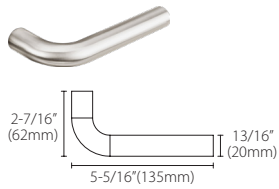

101 Cologne
(32, 32D, CGY, CDB, C19G, C19)

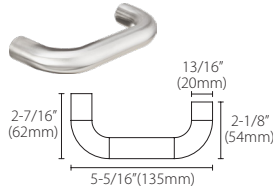

102 Munich
(32, 32D, CGY, CDB, C19G, C19)

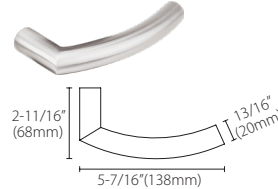

103 Oslo
(32, 32D, CGY, CDB, C19G, C19)

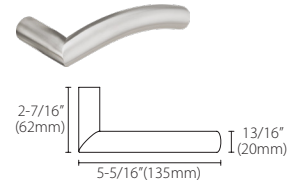

104 Brussels
(32, 32D, CGY, CDB, C19G, C19)

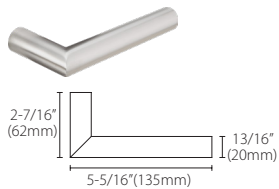

105 Frankfurt
(32, 32D, 10B, 19G, PVD4, CGY, CDB, C19G, C19)

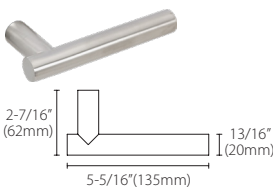

106 Copenhagen
(32, 32D, 10B, CGY, CDB, C19G, C19)

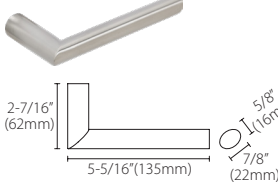

107 Stockholm
(32, 32D, CGY, CDB, C19G, C19)

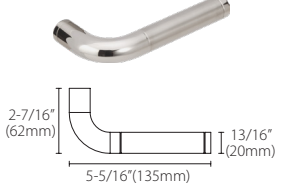

108 Vienna
(PVD4, SP, SP-PVD, CGY, CDB, C19G, C19)

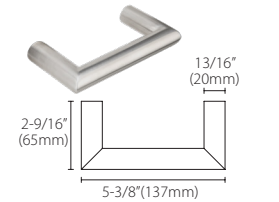

109 Stuttgart
(32, 32D, CGY, CDB, C19G, C19)

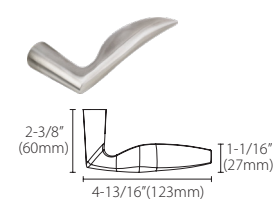

210 Air-stream
(32, 32D, 10B, CGY, CDB, C19G, C19)

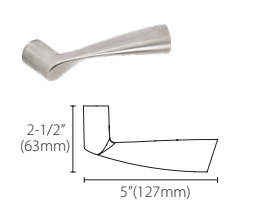

211 Breeze
(32, 32D, 10B, CGY, CDB, C19G, C19)

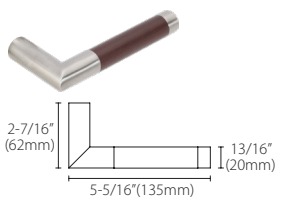

213 Cabernet
(32, 32D, CGY, CDB, C19G, C19)

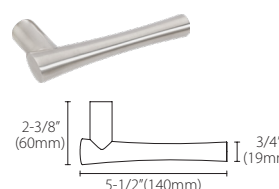

214 Champagne
(32, 32D, 10B, CGY, CDB, C19G, C19)

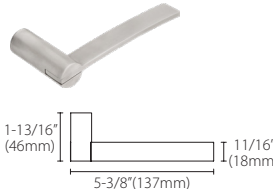

217 Horizon
(32, 32D, CGY, CDB, C19G, C19)

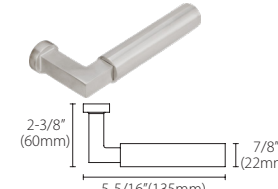

221 Aurora
(32, 32D, 10B, 19G, SP, PVD4, CGY, CDB, C19G, C19)

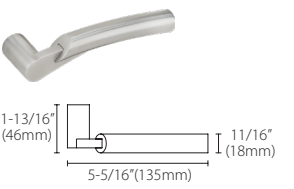

223 Phoenix
(32D, SP, CGY, CDB, C19G, C19)

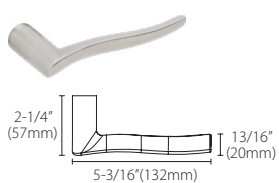

225 Waterfall
(32, 32D, CGY, CDB, C19G, C19)

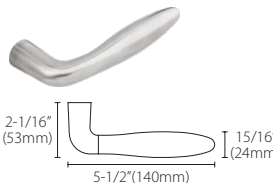

226 Summer
(32, 32D, CGY, CDB, C19G, C19)

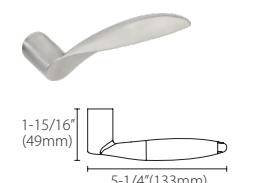

227 Stratus
(32, 32D, CGY, CDB, C19G, C19)

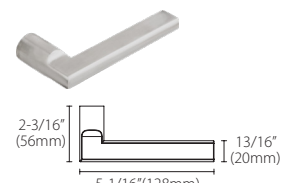

243 Sunrise
(32, 32D, 10B, 19G, PVD4, CGY, CDB, C19G, C19)

LIST PRICES
Lever Design Overview

Lever Design Overview

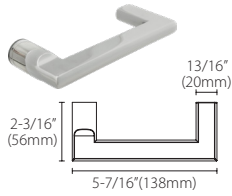

244 Twilight
(32, 32D, PVD4,
CGY, CDB, C19G, C19)

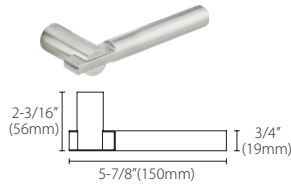

251 Sequoia
(32, 32D, SP, CGY, CDB,
C19G, C19)

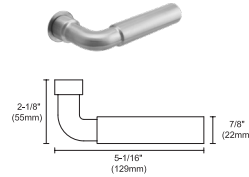

276 Plaza
(32, 32D, 19G, PVD4, CGY,
CDB, C19G, C19)

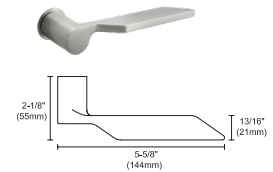

300 Napa
(32, 32D, 19G, CGY, CDB,
C19G, C19)

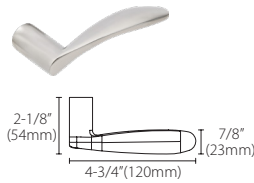

311 Crest
(32, 32D, 10B, CGY, CDB,
C19G, C19)

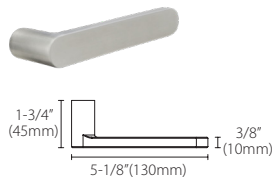

318 Café
(32, 32D, 10B, 19G, PVD4,
CGY, CDB, C19G, C19)

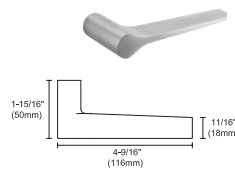

319 Hampton
(32, 32D, 19G, PVD4
CGY, CDB, C19G, C19)

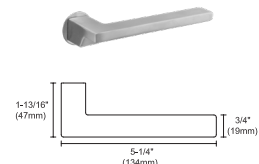

320 Empire
(32, 32D, 19G, PVD4
CGY, CDB, C19G, C19)

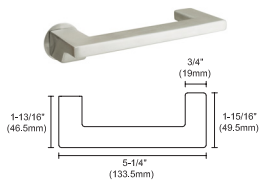

321 Valencia
(32, 32D, 10B, 19G, PVD4, CGY,
CDB, C19G, C19)

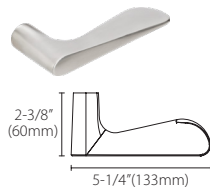

344 Ecco
(32, 32D, CGY, CDB, C19G, C19)

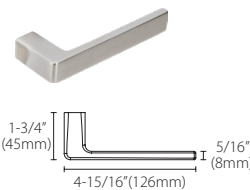

345 Tokyo
(32, 32D, 10B, 19G, PVD4,
CGY, CDB, C19G, C19)

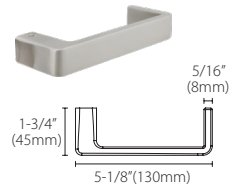

346 Osaka
(32, 32D, CGY, CDB, C19G, C19)

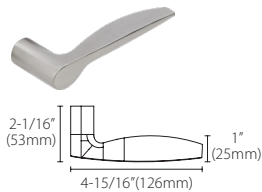

351 Toronto
(32, 32D, CGY, CDB, C19G, C19)

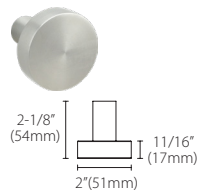

379 Arctic
(32, 32D, CGY, CDB, C19G, C19)

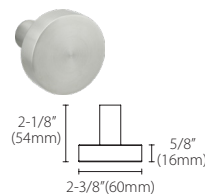

380 Polaris
(32, 32D, CGY, CDB, C19G, C19)

Functions Overview

Tubular Latchsets (Non-Keyed Lock RA, SE, LA, SF, GA, GT, GS, SH)

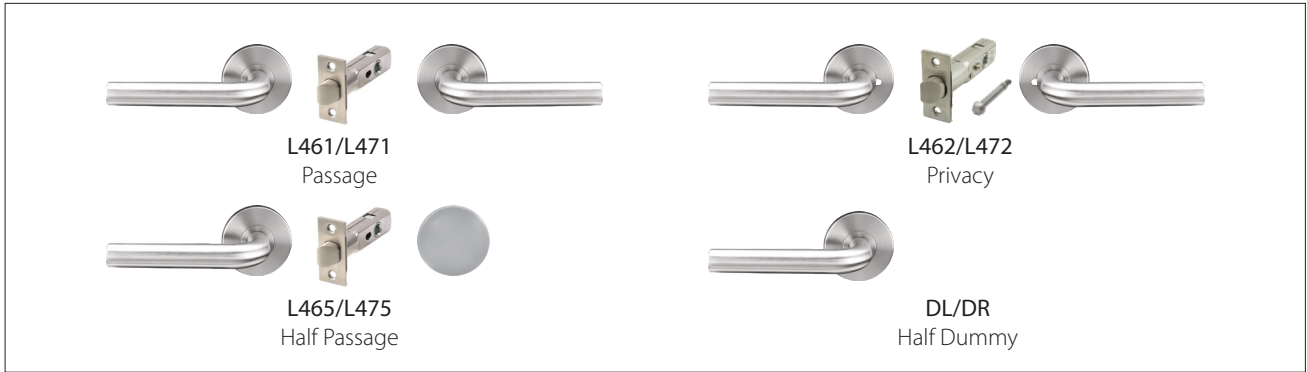

Tubular Entry Sets (SF / LA Plates)

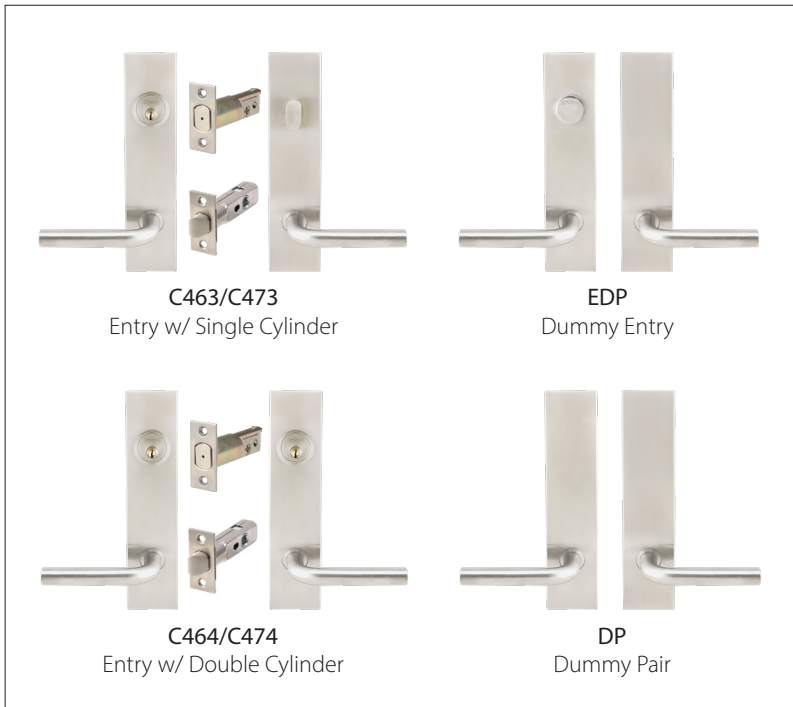

Mortise Non-Keyed Lock



Mortise Keyed Lock with Deadbolt

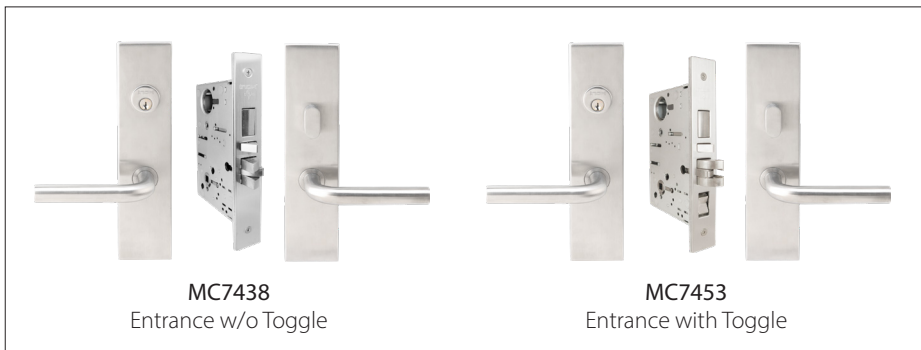

Mortise Full Dummy



Functions Overview

Mortise Keyed Lock without Deadbolt



Tubular Handlesets (NY/MH Plates)



Mortise Handlesets (NY/MH/ME/BW Plates)



Multipoint Trim (BP/MU Plates)



Rose & Plate Designs

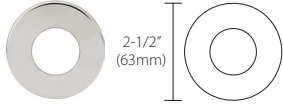

RA Rose

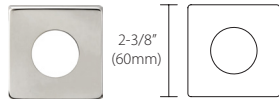

SE Rose

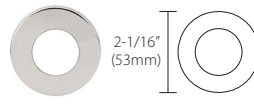

GT Rose

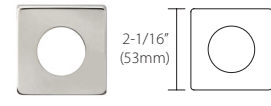

GS Rose

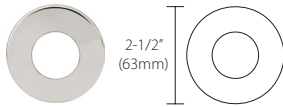

XRA Rose

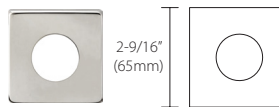

XSE Rose

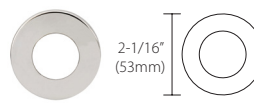

XGT Rose

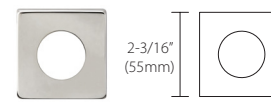

XGS Rose

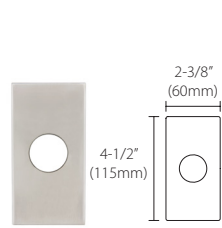

SH Plate

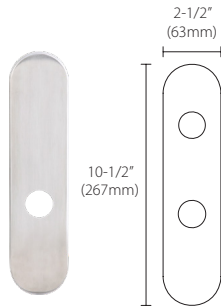

LA Plate

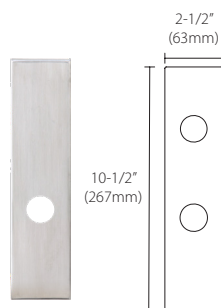

SF Plate

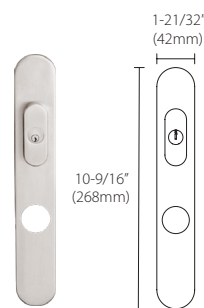

BP Plate



MU Plate

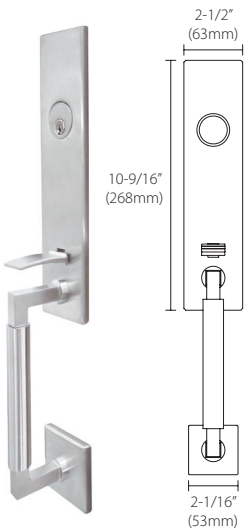

NY Plate

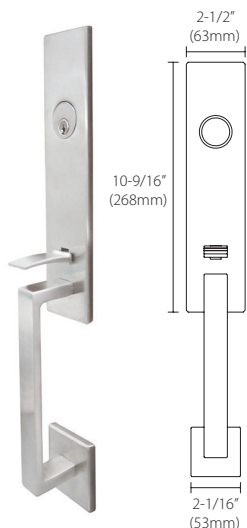

MH Plate



ME Plate



BW Plate

LIST PRICES

Rose & Plate Designs

INOX Finish Collection

Stocked finishes on stocked items - 1 to 2 weeks

Stocked finishes on limited items - 2 to 4 weeks

Stocked CeraMax finishes on stocked items - 2 to 4 weeks

Special order CeraMax finishes on stocked items - 6 to 8 weeks including setup fee, see page 107

Special order finishes on custom orders – 12 to 16 weeks, MOQ may apply

Key

PVD: Physical Vapor Deposition

EP: Electroplating









































SS: Stainless Steel

CeraMax: Ceramic Coating











Finish Swatch	Finish Code	Finish Description	Material / Coating	Stocked	Special Order
	32	Bright Stainless Steel	SS	√	
	32D	Satin Stainless Steel	SS	√	
	15	Satin Nickel	EP		√
	26D	Satin Chrome	EP		√
	14	Polished Nickel	PVD		√
	26	Polished Chrome	EP		√
	3UNL	Unlacquered Brass	Brass		√
	3	Bright Brass	PVD		√
	36	Champagne	PVD		√
	4	Satin Brass	PVD	√	
	38	Aged Brass	EP		√
	39	Aged Gold	PVD		√
	40	Rose Gold	PVD		√
	41	Amber	PVD		√
	50	Platinum	PVD		√
	51	Espresso	PVD		√
	65	Black Pearl	PVD		√
	15A	Pewter	EP		√
	10B	Oil Rubbed Bronze	EP	√	
	19G	Graphite Black	EP	√	
	C19G	Graphite Black	CeraMax	√	
	C19	Flat Black	CeraMax	√	
	CGY	Stormy Grey	CeraMax	√	
	CDB	Dark Bronze	CeraMax	√	
	C20	Rainbeaux – Bordeaux	CeraMax		√
	C21	Rainbeaux – Sun Dazed	CeraMax		√
	C22	Rainbeaux – Pink Bubblegum	CeraMax		√
	C23	Rainbeaux – Goblin Green	CeraMax		√
	C24	Rainbeaux – Ocean Blue	CeraMax		√
	C25	Rainbeaux – Purple Reign	CeraMax		√
	C26	Rainbeaux – Aqua Blue	CeraMax		√
	C27	Rainbeaux – Deep Blue Sea	CeraMax		√
	C28	Rainbeaux – Red Hot	CeraMax		√
	C29	Rainbeaux – Sand Man	CeraMax		√
	C30	Rainbeaux – Moon Light	CeraMax		√
	C31	Rainbeaux – Cobalt Cool	CeraMax		√

HOW TO ORDER Tubular Locksets for Swing Doors

To order locksets, please describe the additional requirements in the same sequence as below. Parts or service upcharges may apply.

Rose	Lever	Function	Finish	Handing
SH	318	L472	-32D	-LH
1	2	3	4	5
ROSE	LEVER	FUNCTION		
 RA  SE  GA  GS  GT  GS	 101  102  103  104  105  106  107  108  109  210  211  213  214  217  221  223  225  226  227  243  244  251  276  300  311  318  319  320  321  344  345  346  351  379  380	L461 Passage, 2-3/8" Backset, TL4 Latch L462 Privacy, 2-3/8" Backset, TL4 Latch L465 Half Passage, 2-3/8" Backset, TL4 Latch L471 Passage, 2-3/4" Backset, TL4 Latch L472 Privacy, 2-3/4" Backset, TL4 Latch L475 Half Passage, 2-3/4" Backset, TL4 Latch DL Dummy Left DR Dummy Right <i>379 only available in GA/GS/GT/SH</i> <i>380 only available in RA/SE/SH</i>		

4 FINISH

Standard:					
	-32D	-32	-19G	-PVD4	-SP
					
	-10B	-C19G	-C19	-CGY	-CDB
					
	-CBB				



5 HANDING

-RH = Right Hand -LH = Left Hand -RHR = Right Hand Reverse -LHR = Left Hand Reverse

TL4 Tubular Locks
LIST PRICES

TL4 Tubular Locksets by RA / SE

Interior Locksets for bedroom, bath, closet doors
Quick Ship 3-5 business days for 20 sets or less excluding CeraMax

					Finish			
					32D	32, 19G	PVD4	CeraMax ¹
Rose	Quick Ship Lever Design	Function	Function Code by Backset		Price			
			2-3/8"	2-3/4"				
 <p>RA standard round rose 2-1/2" diameter</p>  <p>SE standard square rose 2-3/8" x 2-3/8"</p>	101 Cologne 105 Frankfurt	Passage	L461	L471	\$188	\$208	\$208	\$368
		Privacy	L462	L472	\$188	\$208	\$208	\$368
		Half Passage ⁸	L465	L475	\$148	\$188	\$188	\$298
		Single Dummy ⁸	DL/DR		\$98	\$128	\$128	\$218
	221 Aurora 243 Sunrise 276 Plaza 319 Hampton 320 Empire 345 Tokyo	Passage	L461	L471	\$228	\$248	\$248	\$408
		Privacy	L462	L472	\$228	\$248	\$248	\$408
		Half Passage ⁸	L465	L475	\$178	\$198	\$198	\$328
		Single Dummy ⁸	DL/DR		\$118	\$138	\$138	\$238

¹ Finish Option

CeraMax Standard Finishes: C19G Graphite Black, C19 Flat Black, CGY Stormy Grey, CDB Dark Bronze, and CBB Burnt Bronze.

⁸ Specify handing for Half Passage, Single Dummy



When ordering, TL4 Grade 2 latches are designated "L4".

For split finishes between outside and inside trim; please use the higher finish price with an upcharge of \$30

For complete sets using TL4 Fire-rated latches, please add "F" behind function code (e.g. SE105L462F-32D). Add \$30 upcharge to all TL4 latchset list prices.

TL4 Tubular Locksets by RA / SE

Interior Locksets for bedroom, bath, closet doors
 Non-Quick Ship 5-10 business days for 20 sets or less

					Finish				
					32D	32, 19G, 10B, SP	PVD4	CeraMax ¹	
Rose	Lever Design	Function	Function Code by Backset		Price				
			2-3/8"	2-3/4"					
 <p>RA standard round rose 2-1/2" diameter</p>  <p>SE standard square rose 2-3/8" x 2-3/8"</p>	102 Munich 103 Oslo 104 Brussels 106 Copenhagen ¹ 108 Vienna ¹ 107 Stockholm 108 Vienna ¹ 109 Stuttgart 213 Cabernet 226 Summer 380 Polaris Knob	Passage	L461	L471	\$218	\$238	\$238	\$398	
		Privacy	L462	L472	\$218	\$238	\$238	\$398	
		Half Passage ⁸	L465	L475	\$158	\$178	\$178	\$308	
		Single Dummy ⁸	DL/DR		\$98	\$128	\$128	\$218	
		210 Air-stream ¹ 211 Breeze ¹ 214 Champagne ¹ 217 Horizon 223 Phoenix 225 Waterfall 227 Stratus 244 Twilight 251 Sequoia 300 Napa 311 Crest ¹ 318 Café ¹ 344 Ecco 346 Osaka 351 Toronto	Passage	L461	L471	\$258	\$278	\$278	\$438
			Privacy	L462	L472	\$258	\$278	\$278	\$438
			Half Passage ⁸	L465	L475	\$178	\$208	\$208	\$328
			Single Dummy ⁸	DL/DR		\$118	\$138	\$138	\$238

¹ Finish Option

CeraMax Standard Finishes: C19G Graphite Black, C19 Flat Black, CGY Stormy Grey, CDB Dark Bronze, and CBB Burnt Bronze.
 PVD4 finish available in 108 lever design.
 10B finish available in 106, 210, 211, 214, 311 and 318 lever designs.
 19G finish available in 300 lever design.
 SP is a dual-tone stainless steel finish and available in the 108, 223, and 251 lever designs.
 32D is not available for the 108 lever design.

⁸ Specify handing for Half Passage, Single Dummy

When ordering, TL4 Grade 2 latches are designated "L4".



For split finishes between outside and inside trim; please use the higher finish price with an upcharge of \$30

For complete sets using TL4 Fire-rated latches, please add "F" behind function code (e.g. SE105L462F-32D). Add \$30 upcharge to all TL4 latchset list prices.

LIST PRICES TL4 Tubular Locks

TL4 Tubular Locksets by GT/ SH

Interior Locksets for bedroom, bath, closet doors
 Non-Quick Ship 5-10 business days for 20 sets or less

					Finish			
					32D	32, 19G, 10B	PVD4	CeraMax ¹
Rose	Lever Design	Function	Function Code by Backset		Price			
			2-3/8"	2-3/4"				
 SH rectangular plate 4-1/2" x 2-3/8"  GT round rose ⁹ 2-1/16" diameter	101 Cologne 102 Munich 103 Oslo 104 Brussels 105 Frankfurt ¹ 106 Copenhagen ¹ 107 Stockholm 108 Vienna ¹ 109 Stuttgart 213 Cabernet 226 Summer 379 Arctic Knob 380 Polaris Knob	Passage Privacy Half Passage ⁸ Single Dummy ⁸	L461 L462 L465 DL/DR	L471 L472 L475 DL/DR	\$238 \$238 \$188 \$128	\$258 \$258 \$208 \$148	\$258 \$258 \$208 \$148	\$418 \$418 \$338 \$248
	210 Air-stream ¹ 211 Breeze ¹ 214 Champagne ¹ 217 Horizon 221 Aurora ¹ 223 Phoenix 225 Waterfall 227 Stratus 243 Sunrise ¹ 244 Twilight 251 Sequoia 276 Plaza ¹ 300 Napa ¹ 311 Crest ¹ 318 Café ¹ 319 Hampton ¹ 320 Empire ¹ 344 Ecco 345 Tokyo ¹ 346 Osaka 351 Toronto	Passage Privacy Half Passage ⁸ Single Dummy ⁸	L461 L462 L465 DL/DR	L471 L472 L475 DL/DR	\$278 \$278 \$208 \$138	\$298 \$298 \$218 \$158	\$298 \$298 \$218 \$158	\$458 \$458 \$358 \$258

¹ Finish Option

CeraMax Standard Finishes: C19G Graphite Black, C19 Flat Black, CGY Stormy Grey, CDB Dark Bronze, and CBB Burnt Bronze.
 PVD4 finish available for the SH plate in 101, 105, 108, 243, 276, 319, 320 and 435 lever design.
 10B finish available in 106, 210, 211, 214, 311 and 318 lever designs.
 19G finish available for the SH plate in 300 lever design.
 SP is a dual-tone stainless steel finish and available in the 108, 223, and 251 lever designs.
 32D is not available for the 108 lever design.

⁸ Specify handing for Half Passage, Single Dummy



When ordering, TL4 Grade 2 latches are designated "L4".

For split finishes between outside and inside trim; please use the higher finish price with an upcharge of \$30

For complete sets using TL4 Fire-rated latches, please add "F" behind function code (e.g. SE105L462F-32D). Add \$30 upcharge to all TL4 latchset list prices.

TL4 Tubular Locksets by GA/ GS

Interior Locksets for bedroom, bath, closet doors
 Non-Quick Ship 5-10 business days for 20 sets or less

					Finish					
					32D	32, 19G	PVD4	CeraMax		
Rose	Lever Design	Function	Function Code by Backset		Price					
			2-3/8"	2-3/4"						
 <p>GA standard round rose 2-1/2" diameter</p>  <p>GS standard square rose 2-3/8" x 2-3/8"</p>	101 Cologne 102 Munich 103 Oslo 104 Brussels 105 Frankfurt ¹ 106 Copenhagen ¹ 107 Stockholm 108 Vienna ¹ 109 Stuttgart 213 Cabernet 226 Summer 379 Arctic Knob 380 Polaris Knob	Passage	L461	L471	\$288	\$308	\$308	\$468		
		Privacy	L462	L472	\$288	\$308	\$308	\$468		
		Half Passage ⁸	L465	L475	\$218	\$238	\$238	\$368		
		Single Dummy ⁸	DL/DR		\$148	\$168	\$168	\$268		
		210 Air-stream ¹ 211 Breeze ¹ 214 Champagne ¹ 217 Horizon 221 Aurora ¹ 223 Phoenix 225 Waterfall	Passage	L461	L471	\$328	\$348	\$348	\$508	
			Privacy	L462	L472	\$328	\$348	\$348	\$508	
			Half Passage ⁸	L465	L475	\$258	\$278	\$278	\$408	
			Single Dummy ⁸	DL/DR		\$188	\$208	\$208	\$308	
			227 Stratus 243 Sunrise ¹ 244 Twilight 251 Sequoia 276 Plaza ¹ 300 Napa ¹ 311 Crest ¹ 318 Café ¹ 319 Hampton ¹ 320 Empire ¹ 344 Ecco 345 Tokyo ¹ 346 Osaka 351 Toronto	Passage	L461	L471	\$328	\$348	\$348	\$508
				Privacy	L462	L472	\$328	\$348	\$348	\$508
				Half Passage ⁸	L465	L475	\$258	\$278	\$278	\$408
				Single Dummy ⁸	DL/DR		\$188	\$208	\$208	\$308

¹ Finish Option

CeraMax Standard Finishes: C19G Graphite Black, C19 Flat Black, CGY Stormy Grey, CDB Dark Bronze, and CBB Burnt Bronze.
 PVD4 finish available for the SH plate in 101, 105, 108, 243, 276, 319, 320 and 435 lever design.
 10B finish available in 106, 210, 211, 214, 311 and 318 lever designs.
 19G finish available for the SH plate in 300 lever design.
 SP is a dual-tone stainless steel finish and available in the 108, 223, and 251 lever designs.
 32D is not available for the 108 lever design.

⁸ Specify handing for Half Passage, Single Dummy

When ordering, TL4 Grade 2 latches are designated "L4".

For split finishes between outside and inside trim; please use the higher finish price with an upcharge of \$30

For complete sets using TL4 Fire-rated latches, please add "F" behind function code (e.g. SE105L462F-32D). Add \$30 upcharge to all TL4 latchset list prices.

HOW TO ORDER

Magnetic Tubular Locksets for Swing Doors

To order locksets, please describe the additional requirements in the same sequence as below. Parts or service upcharges may apply.

Rose	Lever	Function	Finish	Handing
SH	318	L772	-32D	-LH
1	2	3	4	5
ROSE	LEVER	FUNCTION		
<p>RA SE GA GS GT GS</p>	<p>101 102 103 104 105 106 107 108 109 210 211 213 214 217 221 223 225 226 227 243 244 251 276 300 311 318 319 320 321 344 345 346 351 379 380</p>	<p>L761 Passage, 2-3/8" Backset, TL7 Latch L762 Privacy, 2-3/8" Backset, TL7 Latch L765 Half Passage, 2-3/8" Backset, TL7 Latch L771 Passage, 2-3/4" Backset, TL7 Latch L772 Privacy, 2-3/4" Backset, TL7 Latch L775 Half Passage, 2-3/4" Backset, TL7 Latch</p> <p>DL Dummy Left DR Dummy Right</p> <p><i>379 only available in GA/GS/GT/SH</i> <i>380 only available in RA/SE/SH</i></p>		

4 FINISH

Standard:



-32D	-32	-19G	-PVD4	-SP
-10B	-C19G	-C19	-CGY	-CDB
-CBB				

5 HANDING

-RH = Right Hand -LH = Left Hand -RHR = Right Hand Reverse -LHR = Left Hand Reverse

TL7 Tubular Locksets by RA / SE

Interior Locksets for bedroom, bath, closet doors
Quick Ship 3-5 business days for 20 sets or less excluding CeraMax

					Finish			
					32D	32, 19G	PVD4	CeraMax
Rose	Quick Ship Lever Design	Function	Function Code by Backset		Price			
			2-3/8"	2-3/4"				
 <p>RA standard round rose 2-1/2" diameter</p>  <p>SE standard square rose 2-3/8" x 2-3/8"</p>	101 Cologne 105 Frankfurt	Passage	L761	L771	\$228	\$248	\$248	\$408
		Privacy	L762	L772	\$228	\$248	\$248	408
		Half Passage ⁸	L765	L775	\$188	\$208	\$208	\$338
		Single Dummy ⁸	DL/DR		\$98	\$128	\$128	\$218
	221 Aurora 243 Sunrise 276 Plaza 319 Hampton 320 Empire 345 Tokyo	Passage	L761	L771	\$268	\$288	\$288	\$448
		Privacy	L762	L772	\$268	\$288	\$288	\$448
		Half Passage ⁸	L765	L775	\$218	\$238	\$238	\$368
		Single Dummy ⁸	DL/DR		\$118	\$138	\$138	\$238

¹ Finish Option

CeraMax Standard Finishes: C19G Graphite Black, C19 Flat Black, CGY Stormy Grey, CDB Dark Bronze, and CBB Burnt Bronze.

⁸ Specify handing for Half Passage, Single Dummy



When ordering, TL4 Grade 2 latches are designated "L4".

For split finishes between outside and inside trim; please use the higher finish price with an upcharge of \$30

For complete sets using TL4 Fire-rated latches, please add "F" behind function code (e.g. SE105L462F-32D). Add \$30 upcharge to all TL4 latchset list prices.

TL7 Tubular Locksets by RA / SE

Interior Locksets for bedroom, bath, closet doors
 Non-Quick Ship 5-10 business days for 20 sets or less

					Finish				
					32D	32, 19G, 10B, SP	PVD4	CeraMax	
Rose	Lever Design	Function	Function Code by Backset		Price				
			2-3/8"	2-3/4"					
 <p>RA standard round rose 2-1/2" diameter</p>  <p>SE standard square rose 2-3/8" x 2-3/8"</p>	102 Munich 103 Oslo 104 Brussels 106 Copenhagen ¹ 108 Vienna ¹ 107 Stockholm 108 Vienna ¹ 109 Stuttgart 213 Cabernet 226 Summer 380 Polaris Knob	Passage	L761	L771	\$258	\$278	\$278	\$438	
		Privacy	L762	L772	\$258	\$278	\$278	\$438	
		Half Passage ⁸	L765	L775	\$198	\$218	\$218	\$348	
		Single Dummy ⁸	DL/DR		\$98	\$128	\$128	\$218	
		210 Air-stream ¹ 211 Breeze ¹ 214 Champagne ¹ 217 Horizon 223 Phoenix 225 Waterfall 227 Stratus 244 Twilight 251 Sequoia 300 Napa 311 Crest ¹ 318 Café ¹ 344 Ecco 346 Osaka 351 Toronto	Passage	L761	L771	\$298	\$318	\$318	\$478
			Privacy	L762	L772	\$298	\$318	\$318	\$478
			Half Passage ⁸	L765	L775	\$218	\$238	\$238	\$368
			Single Dummy ⁸	DL/DR		\$118	\$138	\$138	\$238

¹ Finish Option

CeraMax Standard Finishes: C19G Graphite Black, C19 Flat Black, CGY Stormy Grey, CDB Dark Bronze, and CBB Burnt Bronze.
 PVD4 finish available for the SH plate in 101, 105, 108, 243, 276, 319, 320 and 435 lever design.
 10B finish available in 105, 106, 210, 211, 214, 311 and 318 lever designs.
 19G finish available for the SH plate in 300 lever design.
 SP is a dual-tone stainless steel finish and available in the 108, 223, and 251 lever designs.
 32D is not available for the 108 lever design.

⁸ Specify handing for Half Passage, Single Dummy

When ordering, TL4 Grade 2 latches are designated "L4".



For split finishes between outside and inside trim; please use the higher finish price with an upcharge of \$30

For complete sets using TL4 Fire-rated latches, please add "F" behind function code (e.g. SE105L462F-32D). Add \$30 upcharge to all TL4 latchset list prices.

TL7 Tubular Locksets by GT/ SH

Interior Locksets for bedroom, bath, closet doors
 Non-Quick Ship 5-10 business days for 20 sets or less

TL7 Tubular Locks LIST PRICES



					Finish				
					32D	32, 19G	PVD4	CeraMax	
Rose	Lever Design	Function	Function Code by Backset		Price				
			2-3/8"	2-3/4"					
 <p>SH rectangular plate 4-1/2" x 2-3/8"</p>  <p>GT round rose⁹ 2-1/16" diameter</p>	101 Cologne 102 Munich 103 Oslo 104 Brussels 105 Frankfurt ¹ 106 Copenhagen ¹ 107 Stockholm 108 Vienna ¹ 109 Stuttgart 213 Cabernet 226 Summer 379 Arctic Knob 380 Polaris Knob	Passage	L761	L771	\$278	\$298	\$298	\$458	
		Privacy	L762	L772	\$278	\$298	\$298	\$458	
		Half Passage ⁸	L765	L775	\$228	\$248	\$248	\$378	
		Single Dummy ⁸	DL/DR		\$128	\$148	\$148	\$248	
		210 Air-stream ¹ 211 Breeze ¹ 214 Champagne ¹ 217 Horizon 221 Aurora ¹ 223 Phoenix 225 Waterfall 227 Stratus 243 Sunrise ¹ 244 Twilight 251 Sequoia 276 Plaza ¹ 300 Napa ¹ 311 Crest ¹ 318 Café ¹ 319 Hampton ¹ 320 Empire ¹ 344 Ecco 345 Tokyo ¹ 346 Osaka 351 Toronto	Passage	L761	L771	\$318	\$338	\$338	\$498
			Privacy	L762	L772	\$318	\$338	\$338	\$498
			Half Passage ⁸	L765	L775	\$248	\$268	\$268	\$398
			Single Dummy ⁸	DL/DR		\$138	\$158	\$158	\$258

¹ Finish Option
 CeraMax Standard Finishes: C19G Graphite Black, C19 Flat Black, CGY Stormy Grey, CDB Dark Bronze, and CBB Burnt Bronze.
 PVD4 finish available for the SH plate in 101, 105, 108, 243,276, 319, 320 and 435 lever design.
 10B finish available in 105, 106, 210, 211, 214, 311 and 318 lever designs.
 19G finish available for the SH plate in 300 lever design.
 SP is a dual-tone stainless steel finish and available in the 108, 223, and 251 lever designs.
 32D is not available for the 108 lever design.

⁸ Specify handing for Half Passage, Single Dummy
 When ordering, TL4 Grade 2 latches are designated "L4".
 For split finishes between outside and inside trim; please use the higher finish price with an upcharge of \$30
 For complete sets using TL4 Fire-rated latches, please add "F" behind function code (e.g. SE105L462F-32D). Add \$30 upcharge to all TL4 latchset list prices.

TL7 Tubular Locksets by GA/ GS

Interior Locksets for bedroom, bath, closet doors
 Non-Quick Ship 5-10 business days for 20 sets or less

					Finish				
					32D	32, 19G	PVD4	CeraMax	
Rose	Lever Design	Function	Function Code by Backset		Price				
			2-3/8"	2-3/4"					
 GA standard round rose 2-1/2" diameter  GS standard square rose 2-3/8" x 2-3/8"	101 Cologne 102 Munich 103 Oslo 104 Brussels 105 Frankfurt ¹ 106 Copenhagen ¹ 107 Stockholm 108 Vienna ¹ 109 Stuttgart 213 Cabernet 226 Summer 379 Arctic Knob 380 Polaris Knob	Passage	L761	L771	\$328	\$348	\$348	\$508	
		Privacy	L762	L772	\$328	\$348	\$348	\$508	
		Half Passage ⁸	L765	L775	\$258	\$278	\$278	\$408	
		Single Dummy ⁸	DL/DR		\$148	\$168	\$168	\$268	
		210 Air-stream ¹ 211 Breeze ¹ 214 Champagne ¹ 217 Horizon 221 Aurora ¹ 223 Phoenix 225 Waterfall	Passage	L761	L771	\$368	\$388	\$388	\$548
			Privacy	L762	L772	\$368	\$388	\$388	\$548
			Half Passage ⁸	L765	L775	\$298	\$318	\$318	\$448
			Single Dummy ⁸	DL/DR		\$188	\$208	\$208	\$308
		227 Stratus 243 Sunrise ¹ 244 Twilight 251 Sequoia 276 Plaza ¹ 300 Napa ¹ 311 Crest ¹ 318 Café ¹ 319 Hampton ¹ 320 Empire ¹ 344 Ecco 345 Tokyo ¹ 346 Osaka 351 Toronto	Passage	L761	L771	\$368	\$388	\$388	\$548
			Privacy	L762	L772	\$368	\$388	\$388	\$548
			Half Passage ⁸	L765	L775	\$298	\$318	\$318	\$448
			Single Dummy ⁸	DL/DR		\$188	\$208	\$208	\$308

¹ Finish Option

CeraMax Standard Finishes: C19G Graphite Black, C19 Flat Black, CGY Stormy Grey, CDB Dark Bronze, and CBB Burnt Bronze.
 PVD4 finish available for the SH plate in 101, 105, 108, 243, 276, 319, 320 and 435 lever design.
 19G finish available for the SH plate in 300 lever design.
 SP is a dual-tone stainless steel finish and available in the 108, 223, and 251 lever designs.
 32D is not available for the 108 lever design.

⁸ Specify handing for Half Passage, Single Dummy





































When ordering, TL4 Grade 2 latches are designated "L4".

For split finishes between outside and inside trim; please use the higher finish price with an upcharge of \$30

For complete sets using TL4 Fire-rated latches, please add "F" behind function code (e.g. SE105L462F-32D). Add \$30 upcharge to all TL4 latchset list prices.

HOW TO ORDER Tubular Locksets for Swing Doors

To order locksets, please describe the additional requirements in the same sequence as below. Parts or service upcharges may apply.

Rose	Lever	Function	Finish	Handing
SE 1	101 2	L372 3	-32D 4	-LH 5
ROSE	LEVER	FUNCTION		
 RA  SE	 101  102  103  104  105  106  107  108  109  143  210  211  213  214  217  221  223  225  226  227  244  251  276  300  311  318  319  320  321  344  345  346  351  380	<p>L361 Passage, 2-3/8" Backset, TL3 Latch L362 Privacy, 2-3/8" Backset, TL3 Latch L365 Half Passage, 2-3/8" Backset, TL3 Latch L371 Passage, 2-3/4" Backset, TL3 Latch L372 Privacy, 2-3/4" Backset, TL3 Latch L375 Half Passage, 2-3/4" Backset, TL3 Latch</p> <p>DL Dummy Left DR Dummy Right</p>		

4 FINISH

Standard:



-32D



-19G



-PVD4

5 HANDING

-RH = Right Hand



-LH = Left Hand

-RHR = Right Hand Reverse

-LHR = Left Hand Reverse

TL3 Tubular Locksets by RA / SE

Interior Locksets for bedroom, bath, closet doors
 Quick Ship 3-5 business days for 20 sets or less excluding CeraMax

					Finish			
					32D	32	19G	PVD4
Rose	Quick Ship Lever Design	Function	Function Code by Backset		Price			
			2-3/8"	2-3/4"				
 <p>RA standard round rose 2-1/2" diameter</p>  <p>SE standard square rose 2-3/8" x 2-3/8"</p>	101 Cologne ¹ 105 Frankfurt ¹	Passage	L361	L371	\$148	\$158	\$158	\$158
		Privacy	L362	L372	\$148	\$158	\$158	\$158
		Half Passage ⁸	L365	L375	\$128	\$138	\$138	\$138
		Single Dummy ⁸	DL/DR		\$98	\$128	\$128	\$128
	143 Sunrise ¹	Passage	L361	L371	\$158	\$168	\$168	\$168
		Privacy	L362	L372	\$158	\$168	\$168	\$168
		Half Passage ⁸	L365	L375	\$138	\$148	\$148	\$148
		Single Dummy ⁸	DL/DR		\$98	\$128	\$128	\$128

¹ Finish Option

PVD4 finish available in 101, 105 and 143 lever designs.
 19G finish available in 105 and 143 lever designs.

⁸ Specify handing for Half Passage, Single Dummy

When ordering, TL3 Grade 2 latches are designated "L3".



For split finishes between outside and inside trim; please use the higher finish price with an upcharge of \$30

TL3 Tubular Locks

LIST PRICES

TL3 Tubular Locksets by RA / SE

Interior Locksets for bedroom, bath, closet doors
 Non-Quick Ship (5-7 business days for 20 sets or less)

					Finish				
					32D	32	19G	PVD4	
Rose	Lever Design	Function	Function Code by Backset		Price				
			2-3/8"	2-3/4"					
 <p>RA standard round rose 2-1/2" diameter</p>  <p>SE standard square rose 2-3/8" x 2-3/8"</p>	102 Munich 103 Oslo 104 Brussels 106 Copenhagen 107 Stockholm 108 Vienna ¹ 109 Stuttgart 213 Cabernet 226 Summer 379 Arctic Knob 380 Polaris Knob	Passage	L361	L371	\$158	\$168	\$168	\$168	
		Privacy	L362	L372	\$158	\$168	\$168	\$168	
		Half Passage ⁸	L365	L375	\$138	\$148	\$148	\$148	
		Single Dummy ⁸	DL/DR		\$98	\$128	\$128	\$128	
		210 Air-stream 211 Breeze 214 Champagne 217 Horizon 221 Aurora ¹ 223 Phoenix 225 Waterfall 227 Stratus 243 Sunrise ¹ 244 Twilight 251 Sequoia 276 Plaza ¹ 300 Napa ¹ 311 Crest 318 Café ¹ 319 Hampton ¹ 320 Empire ¹ 344 Ecco 345 Tokyo ¹ 346 Osaka 351 Toronto	Passage	L361	L371	\$198	\$208	\$208	\$208
			Privacy	L362	L372	\$198	\$208	\$208	\$208
			Half Passage ⁸	L365	L375	\$178	\$188	\$188	\$188
			Single Dummy ⁸	DL/DR		\$118	\$138	\$138	\$138





¹ Finish Option
 PVD4 finish available in 108, 221, 243, 276, 318 and 345 lever designs.
 19G finish available in 221, 243, 276, 300, 319 and 345 lever designs.

⁸ Specify handing for Half Passage, Single Dummy
 When ordering, TL3 Grade 2 latches are designated "L3".
 For split finishes between outside and inside trim; please use the higher finish price with an upcharge of \$30

Tubular Locksets by LA / SF

Interior Locksets for bedroom, office
Exterior Locksets for entrances

Finish			
32D	32, 19G ¹ 10B ¹ SP ¹	PVD4 ¹	CeraMax ¹

Plate with Lower Lever	Lever Design	Function	Function Code by Backset		Price				
			2-3/8"	2-3/4"					
 LA oval plate 10-1/2" x 2-1/2"  SF rectangular plate 10-1/2" x 2-1/2"	101 Cologne 102 Munich 103 Oslo 104 Brussels 105 Frankfurt ¹ 106 Copenhagen ¹ 107 Stockholm 108 Vienna ¹ 109 Stuttgart 213 Cabernet 226 Summer 380 Polaris Knob	Passage	L461	L471	\$388	\$408	\$418	\$668	
		Privacy w/Latch Only	L462	L472	\$388	\$408	\$418	\$668	
		Privacy w/Latch & Bolt ¹⁰	L466	L476	\$448	\$468	\$478	\$728	
		Entry w/Single Cyl	C463	C473	\$458	\$478	\$488	\$738	
		Entry w/Double Cyl	C464	C474	\$508	\$518	\$538	\$808	
		Dummy Entry ¹¹	EDP		\$378	\$398	\$408	\$578	
		Dummy Pair	DP		\$338	\$358	\$368	\$538	
 LA oval plate 10-1/2" x 2-1/2"  SF rectangular plate 10-1/2" x 2-1/2"	210 Air-stream ¹ 211 Breeze ¹ 214 Champagne ¹ 217 Horizon 221 Aurora ¹ 223 Phoenix 225 Waterfall 227 Stratus 243 Sunrise ¹ 244 Twilight 251 Sequoia ¹ 276 Plaza ¹ 300 Napa ¹ 311 Crest ¹ 318 Café ¹ 319 Hampton ¹ 320 Empire ¹ 344 Ecco 345 Tokyo ¹ 346 Osaka 351 Toronto	Passage	L461	L471	\$428	\$448	\$458	\$708	
		Privacy w/Latch Only	L462	L472	\$428	\$448	\$458	\$708	
		Privacy w/Latch & Bolt ¹⁰	L466	L476	\$488	\$508	\$518	\$768	
		Entry w/Single Cyl	C463	C473	\$498	\$518	\$528	\$778	
		Entry w/Double Cyl	C464	C474	\$548	\$568	\$578	\$848	
		Dummy Entry ¹¹	EDP		\$418	\$438	\$448	\$698	
		Dummy Pair	DP		\$358	\$378	\$388	\$558	

¹ **Finish Option**
CeraMax Standard Finishes: C19G Graphite Black, C19 Flat Black, CGY Stormy Grey, CDB Dark Bronze, and CBB Burnt Bronze.
PVD4 finish available for the SF plate in 101, 105, 108, 243, 276, 319, 320 and 435 lever design.
10B finish available in 105, 106, 210, 211, 214, 221, 243, 311, 318 and 345 lever designs.
19G finish available for the SF plate in 105, 221, 243, 276, 300, 318, 319, 320 and 345 lever designs.
SP is a dual-tone stainless steel finish and available in the 108, 221, 223, and 251 lever designs.
32D is not available for the 108 lever design.

¹⁰ Handing for Privacy w/ Latch & Privacy Bolt
¹¹ Dummy Entry includes Dummy Cylinder
For split finishes between outside and inside trim; please use the higher finish price with an upcharge of \$30
For complete sets using TL4 Fire-rated latches, please add "F" behind function code (e.g. SF243L462F-32D); add \$30 upcharge to all TL4 latchset list prices

TL4 Tubular Locks

LIST PRICES

Tubular Latches Parts and Services

Rose Covers, Face Plates, Strikes, Thick Door Kits (TDKs), Thin Door Kits, (TDKs)

Thick Door Kits

Thick Door Kits (TDKs) accommodate a center door prep only. Does not include extended strike.

	Finish	
32D, 32	19G, 10B, PVD4	CeraMax ¹

Door Thickness	Function	Item Code		Price	
RA/SE/GT/GS Tubular Set TDKs					
2" to 2-1/4"	Passage	TDK-RSL2214S	\$58	\$68	\$178
	Privacy	TDK-RSL2214P-FINISH	\$58	\$68	\$178
2-1/2" to 2-3/4"	Passage	TDK-RSL212234S	\$58	\$68	\$178
	Privacy	TDK-RSL212234P-FINISH	\$58	\$68	\$178
3"	Passage	TDK-RSL3S	\$58	\$68	\$178
	Privacy	TDK-RSL3P-FINISH	\$58	\$68	\$178
LA/SF Tubular Set TDKs					
2" to 2-1/4"	Passage	TDK-PRL2214-PS	\$58	\$68	\$178
	Privacy	TDK-PRL2214-PV	\$58	\$68	\$178
	Entry	TDK-PRL2214-EN	\$58	\$68	\$178
	Entry Dummy	TDK-PRL2214-EDP	\$58	\$68	\$178
2-1/2" to 2-3/4"	Passage	TDK-PRL212234-PS	\$58	\$68	\$178
	Privacy	TDK-PRL212234-PV	\$58	\$68	\$178
	Entry	TDK-PRL212234-EN	\$58	\$68	\$178
	Entry Dummy	TDK-PRL212234-EDP	\$58	\$68	\$178
3"	Passage	TDK-PRL3-PS	\$58	\$68	\$178
	Privacy	TDK-PRL3-PV	\$58	\$68	\$178
	Entry	TDK-PRL3-CS	\$58	\$68	\$178
	Entry Dummy	TDK-PRL3-EDP	\$58	\$68	\$178

¹ Finish Option

CeraMax Standard Finishes: C19G Graphite Black, C19 Flat Black, CGY Stormy Grey, CDB Dark Bronze, and CBB Burnt Bronze.

Tubular Latches Parts and Services

Rose Covers, Face Plates, Strikes, Thick Door Kits (TDKs), Thin Door Kits, (TDKs)

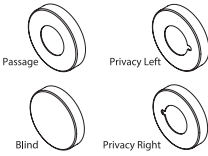
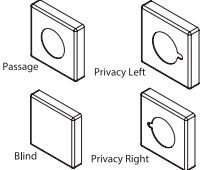
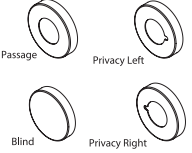
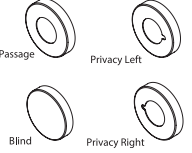
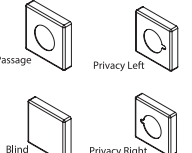
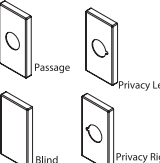
			Finish			
			32D	32, 10B, 19G ¹	PVD4 ¹	CeraMax ¹
Rose Covers						
Illustration	Function	Item Code	Price (EA)			
RA Rose Covers 	Passage/Dummy	PR-RA01	\$19	\$21	\$26	\$79
	Privacy Left	PR-RA02L	\$19	\$21	\$26	\$79
	Privacy Right	PR-RA02R	\$19	\$21	\$26	\$79
	Blind	PR-RA03	\$19	\$21	\$26	\$79
SE Rose Covers 	Passage/Dummy	PR-SE01	\$19	\$21	\$26	\$79
	Privacy Left	PR-SE02L	\$19	\$21	\$26	\$79
	Privacy Right	PR-SE02R	\$19	\$21	\$26	\$79
	Blind	PR-SE03	\$19	\$21	\$26	\$79
GT Rose Covers 	Passage/Dummy	PR-GT01	\$19	\$21	\$26	\$79
	Privacy Left	PR-GT02L	\$19	\$21	\$26	\$79
	Privacy Right	PR-GT02R	\$19	\$21	\$26	\$79
	Blind	PR-GT03	\$19	\$21	\$26	\$79
GA Rose Covers 	Passage/Dummy	PR-GA01	\$19	\$21	\$26	\$79
	Privacy Left	PR-GA02L	\$19	\$21	\$26	\$79
	Privacy Right	PR-GA02R	\$19	\$21	\$26	\$79
	Blind	PR-GA03	\$19	\$21	\$26	\$79
GS Rose Covers 	Passage/Dummy	PR-GS01	\$19	\$21	\$26	\$79
	Privacy Left	PR-GS02L	\$19	\$21	\$26	\$79
	Privacy Right	PR-GS02R	\$19	\$21	\$26	\$79
	Blind	PR-GS03	\$19	\$21	\$26	\$79
SH Plate Covers 	Passage/Dummy	PR-SH01	\$19	\$21	\$26	\$79
	Privacy Left	PR-SH02L	\$19	\$21	\$26	\$79
	Privacy Right	PR-SH02R	\$19	\$21	\$26	\$79
	Blind	PR-SH03	\$19	\$21	\$26	\$79

¹ Finish Options
 PVD4 finish available for RA, SE, GA and SH
 19G finish available for RA, SE, GA and SH
 CeraMax Standard Finishes: C19G Graphite Black, C19 Flat Black, CGY Stormy Grey, CDB Dark Bronze, and CBB Burnt Bronze.

Tubular - Parts & Services
LIST PRICES

Tubular Latches Parts and Services

Rose Covers, Face Plates, Strikes, Thick Door Kits (TDKs), Thin Door Kits, (TDKs)

Image		Function	Item Code	Finish			
				32D, 32	10B, 19G ¹	PVD4 ¹	CeraMax ¹
LA	SF		Price (EA)				
		Tubular Entry, outside cover plate	PR-LA88 PR-SF88	\$31	\$41	\$47	\$101
		Tubular Entry, inside cover plate	PR-LA89 PR-SF89	\$31	\$41	\$47	\$101
		Tubular Passage / Dummy inside or outside cover plate	PR-LA90 PR-SF90	\$31	\$41	\$47	\$101
		Tubular Privacy LH (for Privacy Pin)	PR-LA95L PR-SF95L	\$31	\$41	\$47	\$101
		Tubular Privacy RH (for Privacy Pin)	PR-LA95R PR-SF95R	\$31	\$41	\$47	\$101

Cover plates are not removable for pre-rose assembly lever designs and outside mortise privacy escutcheons (PD-LA92 and PE-SF92)

¹ **Finish Options**

PVD4 finish available in SF

19G finish available in SF

CeraMax Standard Finishes: C19G Graphite Black, C19 Flat Black, CGY Stormy Grey, CDB Dark Bronze, and CBB Burnt Bronze.

Tubular Latches Parts and Services

Rose Covers, Face Plates, Strikes, Thick Door Kits (TDKs), Thin Door Kits, (TDKs)





Faceplates and Strikes			Finish			
			32D	32, 10B, 19G	PVD4	CeraMax ¹
Illustration	Function	Item Code	Price			
TL4 Faceplates 	Standard	TL4-FSP	\$19	\$21	\$23	\$59
	1/4" Radius Corner	TL4-FSP14	\$19	\$21	N/A	\$59
TL7 Faceplate 	Standard	TL7-FSP	\$19	\$21	\$23	\$59
Full-Lip Strikes 	Passage	LSR-D1	\$19	\$21	\$23	\$59
	1/4" Radius Corner	LSR-D14	\$19	\$21	N/A	\$59
T-Strike 	Square Corner	LSR-T1	\$19	\$21	\$23	\$59
ASA Strike 	Square Corner	LSR-ASA	\$21	\$23	\$25	\$61

Fixing Pack

Door Thickness	Function	Item Code	Price
RA/SE Tubular Set Fixing Packs			
1-3/8" to 1-3/4"	Passage / Privacy / Half Passage	FP-RS01	\$10
1-3/8" and up	Single Dummy	FP-DMY01	\$17
GT/GS Tubular Set Fixing Packs			
1-3/8" to 1-3/4"	Passage/ Privacy / Half Passage	FP-RS03	\$17
1-3/8" and up	Single Dummy	FP-DMY03	\$10
LA/SF Tubular Sets Fixing Pack			
1-3/8" to 1-3/4"	Passage / Privacy with Pin	FP-PRL01	\$17
1-3/4" For Lever Only	Entry	FP-RS03	\$17
1-3/4" Single Cylinder	Entry	FP-DB134SC-T2	\$10
1-3/4" Double Cylinder	Entry	FP-DB134DC	\$10
1-3/8" and Up	Dummy Pair / Dummy Entry	FP-DMY02	\$26

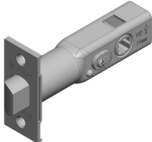
Tubular Latches Parts and Services

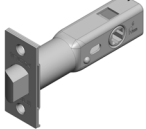
Rose Covers, Face Plates, Strikes, Thick Door Kits (TDKs), Thin Door Kits, (TDKs)

Illustration	Backset	Function	Item Code	Finish				
				32D	32, 10B, 19G	PVD4	CeraMax ¹	
				Price				
TL4, 28 Degree ANSI Grade 2 Latch  Shown: TL472	2-3/8" 2-3/4"	Passage	TL461 TL471	\$68	\$77	\$77	\$138	
	2-3/8" 2-3/4"	Privacy	TL462 TL472	\$68	\$77	\$77	\$138	
	3 Hour Fire-Rated							
	2-3/8" 2-3/4"	Passage	TL461F TL471F	\$102	\$109	\$109	\$172	
2-3/8" 2-3/4"	Privacy	TL462F TL472F	\$102	\$109	\$109	\$172		
TL7, 28 Degree Latch  Shown: TL772	2-3/8" 2-3/4"	Passage	TL761 TL771	\$74	\$85	\$85	\$144	
	2-3/8" 2-3/4"	Privacy	TL762 TL772	\$74	\$85	\$85	\$144	
TL5, 35 Degree Latch for Tubular Entry Handleset  Shown: TL571	2-3/8" 2-3/4"	Passage	TL561 TL571	\$68	\$77	\$77	\$138	
Dummy Latch Kits for Pre-Drilled Door  Shown: RSL7	2-3/8" 2-3/4"	Dummy	PPD-RSL46 PPD-RSL47	\$57	N/A	N/A	\$127	

For Complete Sets using TL4 Fire-rated latches, add "F" behind Function Codes (i.e. RA105L462F-32D) with \$20 upcharge to TL4 Latch set list price

Tubular - Parts & Services LIST PRICES

Tubular Handlesets by NY/MH

Exterior Locksets for entrances

Finish			
32D	32, 19G ¹ 10B ¹ , SP ¹	PVD4 ¹	CeraMax ¹

Plate with Lower Lever	Lever Design	Function	Function Code by Backset		Price			
			2-3/8"	2-3/4"				
 NY Entry Handleset MH Entry Handleset	101 Cologne 102 Munich 103 Oslo 104 Brussels 105 Frankfurt ¹ 106 Copenhagen ¹ 107 Stockholm 108 Vienna ¹ 109 Stuttgart 213 Cabernet 226 Summer 379 Arctic Knob 380 Polaris Knob	Entry	C563	C573	\$608	\$648	\$658	\$1,088
		Dummy Entry ¹¹	TDP		\$528	\$568	\$578	\$958
 NY Entry Handleset MH Entry Handleset	210 Air-stream ¹ 211 Breeze ¹ 214 Champagne ¹ 217 Horizon 221 Aurora ¹ 223 Phoenix 225 Waterfall 227 Stratus 243 Sunrise ¹ 244 Twilight 251 Sequoia ¹ 276 Plaza ¹ 300 Napa ¹ 311 Crest ¹ 318 Café ¹ 319 Hampton ¹ 320 Empire ¹ 344 Ecco 345 Tokyo ¹ 346 Osaka 351 Toronto	Entry	C563	C573	\$648	\$688	\$698	\$1,128
		Dummy Entry ¹¹	TDP		\$568	\$608	\$618	\$998

¹ **Finish Options**
 PVD4 finish available in NY only in the 105, 108, 221, 243, 244, 276, 318, 319, 320 and 345 lever designs.
 19G finish available only in the 105, 221, 243, 276, 300, 318, 319, 320 and 345 lever designs.
 10B finish available in the 105, 106, 210, 211, 214, 221, 243, 311, 318 and 345 lever designs.
 SP is a two-tone stainless steel finish and available in the 108, 221, 223 and 251 lever designs.
 32D finish not available in the 108 lever design.









¹¹ **Dummy Entry** includes Dummy Cylinder
 For split finishes between outside and inside trim; please use the higher finish price with an upcharge of \$30
 All cylinders are keyed different for standard order. Other keying services available.

Tubular Handlesets
LIST PRICES

Mortise Handlesets by NY / MH / ME / BW

Interior Locksets for bedroom, office
Exterior Locksets for entrances

Finish			
32D	32, 19G ¹ 10B ¹ , SP ¹	PVD4 ¹	CeraMax ¹

Plate	Lever Design	Function	Function Code by Backset		Price			
			2-1/2"	2-3/4"				
  NY Entry Handleset MH Entry Handleset	101 Cologne 102 Munich 103 Oslo 104 Brussels 105 Frankfurt ¹ 106 Copenhagen ¹ 107 Stockholm 108 Vienna ¹ 109 Stuttgart 213 Cabernet 226 Summer 379 Arctic Knob 380 Polaris Knob	Entry w/MT Mortise	MT620	MT720	\$818	\$858	\$868	\$1,298
		Dummy Entry ¹¹	MTEDP		\$698	\$738	\$748	\$898
  ME Entry Handleset BW Entry Handleset	210 Air-stream ¹ 211 Breeze ¹ 214 Champagne ¹ 217 Horizon 221 Aurora ¹ 223 Phoenix 225 Waterfall 227 Stratus 243 Sunrise ¹ 244 Twilight 251 Sequoia ¹ 276 Plaza ¹ 300 Napa ¹ 311 Crest ¹ 318 Café ¹ 319 Hampton ¹ 320 Empire ¹ 344 Ecco 345 Tokyo ¹ 346 Osaka 351 Toronto	Entry w/MT Mortise	MT620	MT720	\$858	\$898	\$908	\$1,338
		Dummy Entry ¹¹	MTEDP		\$738	\$778	\$788	\$938
  NY Entry Handleset MH Entry Handleset	210 Air-stream ¹ 211 Breeze ¹ 214 Champagne ¹ 217 Horizon 221 Aurora ¹ 223 Phoenix 225 Waterfall 227 Stratus 243 Sunrise ¹ 244 Twilight 251 Sequoia ¹ 276 Plaza ¹ 300 Napa ¹ 311 Crest ¹ 318 Café ¹ 319 Hampton ¹ 320 Empire ¹ 344 Ecco 345 Tokyo ¹ 346 Osaka 351 Toronto	Entry w/MT Mortise	MT620	MT720	\$838	\$878	\$888	\$1,318
		Dummy Entry ¹¹	MTEDP		\$718	\$758	\$768	\$998
  ME Entry Handleset BW Entry Handleset	210 Air-stream ¹ 211 Breeze ¹ 214 Champagne ¹ 217 Horizon 221 Aurora ¹ 223 Phoenix 225 Waterfall 227 Stratus 243 Sunrise ¹ 244 Twilight 251 Sequoia ¹ 276 Plaza ¹ 300 Napa ¹ 311 Crest ¹ 318 Café ¹ 319 Hampton ¹ 320 Empire ¹ 344 Ecco 345 Tokyo ¹ 346 Osaka 351 Toronto	Entry w/MT Mortise	MT620	MT720	\$878	\$918	\$928	\$1,158
		Dummy Entry ¹¹	MTEDP		\$758	\$798	\$808	\$958

¹ Finish Options
 PVD4 finish available in NY and BW only in the 105, 108, 221, 243, 244, 276, 318, 319, 320 and 345 lever designs.
 19G finish available in NY and MH only in the 105, 221, 243, 276, 300, 318, 319 and 345 lever designs.
 10B finish available in the 105, 106, 210, 211, 214, 221, 243, 311, 318, 320 and 345 lever designs.
 SP is a two-tone stainless steel finish and available in the 108, 221, 223 and 251 lever designs.
 32D finish not available in the 108 lever design.

¹¹ Dummy Entry includes Dummy Cylinder
 For split finishes between outside and inside trim; please use the higher finish price with an upcharge of \$30

Handlesets Parts and Services

Rose Covers, Face Plates, Strikes, Thick Door Kits (TDKs), Thin Door Kits, (TDKs)

Thick Door Kits

NY/ME/MH/BW Mortise Entrysets

NY/MH Tubular Entrysets

Finish	
32, 32D, 19G, PVD4, 10B	CeraMax ¹

Door Thickness	Function	Item Code	Price	
Entry Handlesets TDKs				
2"	Mortise Entry	TDK-MEH200	\$120	\$190
	Mortise Dummy	TDK-MEH200-EDP	\$60	\$130
	Tubular Entry	TDK-TEH200	\$120	\$190
	Tubular Dummy	TDK-TEH200-EDP	\$60	\$130
2-1/4"	Mortise Entry	TDK-MEH214	\$120	\$190
	Mortise Dummy	TDK-MEH214-EDP	\$60	\$130
	Tubular Entry	TDK-TEH214	\$120	\$190
	Tubular Dummy	TDK-TEH214-EDP	\$60	\$130
2-1/2"	Mortise Entry	TDK-MEH212	\$120	\$190
	Mortise Dummy	TDK-MEH212-EDP	\$60	\$130
	Tubular Entry	TDK-TEH212	\$120	\$190
	Tubular Dummy	TDK-TEH212-EDP	\$60	\$130
2-3/4"	Mortise Entry	TDK-MEH234	\$120	\$190
	Mortise Dummy	TDK-MEH234-EDP	\$60	\$130
	Tubular Entry	TDK-TEH234	\$120	\$190
	Tubular Dummy	TDK-TEH234-EDP	\$60	\$130
3"	Mortise Entry	TDK-MEH300	\$120	\$190
	Mortise Dummy	TDK-MEH300-EDP	\$60	\$130
	Tubular Entry	TDK-TEH300	\$120	\$190
	Tubular Dummy	TDK-TEH300-EDP	\$60	\$130

Handlesets - Parts & Services

LIST PRICES

Handlesets Parts and Services

Rose Covers, Face Plates, Strikes, Thick Door Kits (TDKs), Thin Door Kits, (TDKs)

Mortise Handleset Outside Escutcheon Trim

			Finish				
			32D	32,10B, 19G ¹	PVD4 ¹	CeraMax ¹	
Image	Function	Item Code	Price				
	Mortise	ST-NY20E	\$568	\$578	\$588	\$778	
	Tubular	ST-NY20T	\$468	\$478	\$488	\$678	
	Mortise	ST-MH45E	\$568	\$578	\$588	\$778	
	Tubular	ST-MH45T	\$468	\$478	\$488	\$678	
	BW Broadway series - Mortise		ST-BW45E	\$618	\$628	\$638	\$828
	ME Metropolis series - Mortise		ST-ME20E	\$618	\$628	\$638	\$828

Mortise Handleset Inside Plate

			Finish			
			32D	32,10B, 19G ¹	PVD4 ¹	CeraMax ¹
Image	Function	Item Code	Price (EA)			
	Mortise Handleset Inside Escutcheon Plate for MT Lock	PR-SF93	\$38	\$48	\$58	\$108
	Mortise Dummy Inside Escutcheon Plate	PR-SF91	\$38	\$48	\$58	\$108

¹ Finish Options

PVD4 finish available in NY
19G finish available in NY, MH



Fixing Packs

NY/MH Tubular Entry Handleset Fixing Packs			
1-3/4"	Entry / Dummy Entry	FP-TEH01	\$25
NY/ME/MH/BW Mortise Entry Handleset Fixing Packs			
1-3/4"	Entry / Dummy Entry	FP-MEH01	\$15

Universal Multipoint Trim by MU / BP

Multipoint Trim

LIST PRICES

					Finish			
					32D	32, 19G ¹ 10B ¹ , SP ¹	PVD4 ¹	CeraMax ¹
Plate	Lever Design	Function	Lever	Function Code	Price			
 BP plate 10-9/16" x 1-21/32" Shown Lever High (VH) MU plate 10-9/16" x 1-21/32" Shown Lever High (VH)	101 Cologne 102 Munich 103 Oslo 104 Brussels 105 Frankfurt ¹ 106 Copenhagen ¹ 107 Stockholm 108 Vienna ¹ 109 Stuttgart 213 Cabernet 226 Summer 379 Arctic Knob	Passage	High	MA10-VH	\$318	\$358	\$368	\$548
			Low	MA10-VL				
		Patio American	High	MA15-VH	\$338	\$378	\$388	\$568
			Low	MA15-VL				
		Entry American	High	MA55-VH	\$358	\$378	\$388	\$588
			Low	MA55-VL				
		Half Active / Half Dummy	High	MA20-VH	\$318	\$378	\$388	\$548
			Low	MA20-VL				
		Dummy Pair	High	MADP-VH	\$318	\$358	\$368	\$548
			Low	MADP-VL				
		Entry Euro-NO Cylinder	High	MA35-VH	\$318	\$358	\$368	\$548
		Patio Euro-NO Cylinder	High	MA25-VH	\$318	\$358	\$368	\$548
 BP plate 10-9/16" x 1-21/32" Shown Lever Low (VL) MU plate 10-9/16" x 1-21/32" Shown Lever Low (VL)	210 Air-stream ¹ 211 Breeze ¹ 214 Champagne ¹ 217 Horizon 221 Aurora ¹ 223 Phoenix 225 Waterfall 227 Stratus 243 Sunrise ¹ 244 Twilight 251 Sequoia ¹ 276 Plaza ¹ 300 Napa ¹ 311 Crest ¹ 318 Café ¹ 319 Hampton ¹ 320 Empire ¹ 344 Ecco 345 Tokyo ¹ 346 Osaka 351 Toronto	Passage	High	MA10-VH	\$358	\$398	\$408	\$588
			Low	MA10-VL				
		Patio American	High	MA15-VH	\$378	\$418	\$428	\$608
			Low	MA15-VL				
		Entry American	High	MA55-VH	\$398	\$428	\$438	\$628
			Low	MA55-VL				
		Half Active / Half Dummy	High	MA20-VH	\$358	\$398	\$408	\$588
			Low	MA20-VL				
		Dummy Pair	High	MADP-VH	\$358	\$398	\$408	\$588
			Low	MADP-VL				
		Entry Euro-NO Cylinder	High	MA35-VH	\$358	\$398	\$408	\$588
		Patio Euro-NO Cylinder	High	MA25-VH	\$358	\$398	\$408	\$588

¹ Finish Options

PVD4 finish available in MU only in the 105, 108, 221, 243, 244, 276, 318, 319, 320 and 345 lever designs.
 19G finish available in MU only in the 105, 221, 243, 276, 300, 318, 319, 320 and 345 lever designs.
 10B finish available in the 105, 106, 210, 211, 214, 221, 243, 311, 318, and 345 lever designs.
 SP is a two-tone stainless steel finish and available in the 108, 221, 223 and 251 lever designs.
 32D finish not available in the 108 lever design.

For split finishes between outside and inside trim; please use the higher finish price with an upcharge of \$30

Multipoint Parts and Services

Rose Covers, Face Plates, Strikes, Thick Door Kits (TDKs), Thin Door Kits, (TDKs)

Thick Door Kits

Door Thickness	Function	Item Code	Price
2"	Active except MA55	TDK-MP200	\$31
	Half Active/Dummy	TDK-MP200DA	\$31
	Full Dummy	TDK-MP200DP	\$31
	Entry (American Cyl)	TDK-MP200MA55	\$31
2-1/4"	Active except MA55	TDK-MP214	\$31
	Half Active/Dummy	TDK-MP214DA	\$31
	Full Dummy	TDK-MP214DP	\$31
	Entry (American Cyl)	TDK-MP214MA55	\$31
2-1/2"	Active except MA55	TDK-MP212	\$31
	Half Active/Dummy	TDK-MP212DA	\$31
	Full Dummy	TDK-MP212DP	\$31
	Entry (American Cyl)	TDK-MP212MA55	\$31
2-3/4"	Active except MA55	TDK-MP234	\$31
	Half Active/Dummy	TDK-MP234DA	\$31
	Full Dummy	TDK-MP234DP	\$31
	Entry (American Cyl)	TDK-MP234MA55	\$31

Cover Plates

Image		Function	Item Code	Finish			
				32D	32,10B, 19G ¹	PVD4 ¹	CGY, CDB C19G, C19
BP	MU		Price (EA)				
		Passage / Dummy	PR-BP31 PR-MU31	\$38	\$48	\$58	\$108
		American Thumbturn Hole 92mm CTC	PR-BP32 PR-MU32	\$38	\$48	\$58	\$108
		American Cylinder Hole 92mm CTC	PR-BP33 PR-MU33	\$38	\$48	\$58	\$108
		Euro Cylinder Hole 92mm CTC	PR-BP35 PR-MU35	\$38	\$48	\$58	\$108
		Entry Plate and Sub-Plate with American Cylinder Escutcheons	PE-BP53 PE-MU53	\$120	\$130	\$140	\$190

¹ Finish Options
19G and PVD4 finish available in MU

Fixing Packs

BP/MU Multipoint Trim Fixing Packs			
1-3/4"	Passage / Patio / Entry	FP-MP01	\$31
1-3/4"	Half Passage / Half Dummy	FP-MP01DA	\$31
1-3/4"	Full Dummy	FP-MP01DP	\$31

GT Privacy Bolts

With Escutcheons - Non-Keyed

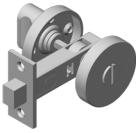
				Finish		
				32D	32, 10B	CeraMax ¹
Privacy Bolt	Function	Backset	Item Code	Price		
	Thumbturn & Release	2-3/8" 2-3/4"	GT04PB62 GT04PB72	\$118	\$138	\$298
	Thumbturn & Release w/ Indicator	2-3/8" 2-3/4"	GT04PB62W GT04PB72W	\$138	\$158	\$318

GS Privacy Bolts

With Escutcheons - Non-Keyed

				Finish		
				32D	32, 10B	CeraMax ¹
Privacy Bolt	Function	Backset	Item Code	Price		
	Thumbturn & Release	2-3/8" 2-3/4"	GS04PB62 GS04PB72	\$118	\$138	\$298
	Thumbturn & Release w/ Indicator	2-3/8" 2-3/4"	GS04PB62W GS04PB72W	\$138	\$158	\$318

GR Privacy Bolts

With Escutcheons - Non-Keyed

				Finish		
				32D	32, 10B	CeraMax ¹
Privacy Bolt	Function	Backset	Item Code	Price		
	Thumbturn & Release	2-3/8" 2-3/4"	GR04PB62 GR04PB72	\$118	\$138	\$298

SR Privacy Bolts

With Escutcheons - Non-Keyed

				Finish		
				32D	32, 10B	CeraMax ¹
Privacy Bolt	Function	Backset	Item Code	Price		
	Thumbturn & Release	2-3/8" 2-3/4"	SR04PB62 SR04PB72	\$118	\$138	\$298

Tubular Deadbolts and Privacy Bolts Parts and Services

Face Plates, Strikes and Dustbox

Illustration	Backset	Function	Item Code	Finish			
				32D	32, 19G, 10B	PVD4	CGY, CDB, C19G, C19
	2-3/8"	Deadlock (non-taper)	BT160	\$45	\$45	\$45	\$105
	2-3/4"	Deadlock (non-taper)	BT170	\$45	\$45	\$45	\$105
3 Hour Fire-Rated							
	2-3/8"	Deadlock (non-taper)	BT160F	\$65	\$75	\$75	\$125
	2-3/4"	Deadlock (non-taper)	BT170F	\$65	\$75	\$75	\$125

Tubular Privacy Bolt

with Faceplate, Strike and Dustbox

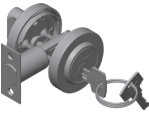

Illustration	Backset	Function	Item Code	Finish			
				32D	32, 19G, 10B	PVD4	CGY, CDB, C19G, C19
	2-3/8"	Privacy Bolt	PB162	\$45	\$45	\$45	\$105
	2-3/4"	Privacy Bolt	PB172	\$45	\$45	\$45	\$105

Faceplates and Strikes

Illustration	Function	Item Code	Finish			
			32D	32, 19G, 10B	PVD4	CGY, CDB, C19G, C19
	Privacy bolt	PB1-FSP	\$11	\$13	\$13	\$51
	Privacy bolt strike and dust box	LSR-PB1	\$26	\$30	\$30	\$66
	Deadbolt	BT1-FSP	\$11	\$13	\$13	\$51
	Deadbolt Strike w/reinforcement plate and dustbox	LSR-BT1	\$26	\$30	\$30	\$66



CD Deadbolts

2-1/2" Round Escutcheon

				Finish			
				32D	32, 10B, 19G	PVD4	CeraMax ¹
Image	Function	Backset	Item No.	Price			
	Single Cylinder	2-3/8"	CD110B6	\$138	\$148	\$158	\$318
		2-3/4"	CD110B7	\$138	\$148	\$158	\$318
		2-3/8"	CD110B6F	\$188	\$198	\$208	\$368
		2-3/4"	CD110B7F	\$188	\$198	\$208	\$368
	Double Cylinder	2-3/8"	CD120B6	\$178	\$188	\$198	\$358
		2-3/4"	CD120B7	\$178	\$188	\$198	\$358
		2-3/8"	CD120B6F	\$228	\$238	\$248	\$408
		2-3/4"	CD120B7F	\$228	\$238	\$248	\$408
	Communicating	2-3/8"	CD192B6	\$128	\$138	\$148	\$308
		2-3/4"	CD192B7	\$128	\$138	\$148	\$308
		2-3/8"	CD192B6F	\$178	\$188	\$198	\$358
		2-3/4"	CD192B7F	\$178	\$188	\$198	\$358



RD Deadbolts

2-3/8" Round Solid Casted Escutcheon

				Finish			
				32D	32, 10B	PVD4	CeraMax ¹
Image	Function	Backset	Item No.	Price			
	Single Cylinder	2-3/8"	RD110B6	\$198	\$208		\$378
		2-3/4"	RD110B7	\$198	\$208	N/A	\$378
		2-3/8"	RD110B6F	\$248	\$258		\$428
		2-3/4"	RD110B7F	\$248	\$258		\$428
	Double Cylinder	2-3/8"	RD120B6	\$248	\$258		\$428
		2-3/4"	RD120B7	\$248	\$258	N/A	\$428
		2-3/8"	RD120B6F	\$298	\$308		\$478
		2-3/4"	RD120B7F	\$298	\$308		\$478
	Communicating	2-3/8"	RD192B6	\$178	\$188		\$358
		2-3/4"	RD192B7	\$178	\$188	N/A	\$358
		2-3/8"	RD192B6F	\$228	\$238		\$408
		2-3/4"	RD192B7F	\$228	\$238		\$408

GD Deadbolts

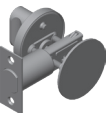

2-1/16" Round Solid Casted Escutcheon

				Finish			
				32D	32, 10B	PVD4	CeraMax ¹
Image	Function	Backset	Item No.	Price			
	Single Cylinder	2-3/8"	GD110B6	\$198	\$208		\$378
		2-3/4"	GD110B7	\$198	\$208	N/A	\$378
		2-3/8"	GD110B6F	\$248	\$258		\$428
		2-3/4"	GD110B7F	\$248	\$258		\$428
	Double Cylinder	2-3/8"	GD120B6	\$248	\$258		\$428
		2-3/4"	GD120B7	\$248	\$258	N/A	\$428
		2-3/8"	GD120B6F	\$298	\$308		\$478
		2-3/4"	GD120B7F	\$298	\$308		\$478
	Communicating	2-3/8"	GD192B6	\$178	\$188		\$358
		2-3/4"	GD192B7	\$178	\$188	N/A	\$358
		2-3/8"	GD192B6F	\$228	\$238		\$408
		2-3/4"	GD192B7F	\$228	\$238		\$408

For split finish between outside and inside, use higher item price with \$30 upcharge

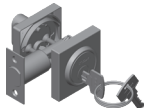

LD Deadbolts

2-3/8" Square Escutcheon

				Finish			
				32D	32, 10B, 19G	PVD4	CeraMax ¹
Image	Function	Backset	Item No.	Price			
	Single Cylinder	2-3/8"	LD310B6	\$148	\$158	\$168	\$328
		2-3/4"	LD310B7	\$148	\$158	\$168	\$328
		2-3/8"	LD310B6F	\$188	\$198	\$208	\$378
		2-3/4"	LD310B7F	\$188	\$198	\$208	\$378
	Double Cylinder	2-3/8"	LD320B6	\$188	\$198	\$208	\$368
		2-3/4"	LD320B7	\$188	\$198	\$208	\$368
		2-3/8"	LD320B6F	\$238	\$248	\$258	\$418
		2-3/4"	LD320B7F	\$238	\$248	\$258	\$418
	Communicating	2-3/8"	LD392B6	\$138	\$148	\$158	\$318
		2-3/4"	LD392B7	\$138	\$148	\$158	\$318
		2-3/8"	LD392B6F	\$188	\$198	\$208	\$368
		2-3/4"	LD392B7F	\$188	\$198	\$208	\$368

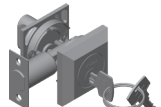
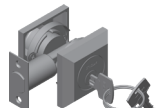

SD Deadbolts

2-3/8" Square Solid Casted Escutcheon

				Finish			
				32D	32, 10B	PVD4	CeraMax ¹
Image	Function	Backset	Item No.	Price			
	Single Cylinder	2-3/8"	SD310B6	\$228	\$238		\$408
		2-3/4"	SD310B7	\$228	\$238	N/A	\$408
		2-3/8"	SD310B6F	\$278	\$288		\$458
		2-3/4"	SD310B7F	\$278	\$288		\$458
	Double Cylinder	2-3/8"	SD320B6	\$278	\$288		\$458
		2-3/4"	SD320B7	\$278	\$288	N/A	\$458
		2-3/8"	SD320B6F	\$328	\$338		\$508
		2-3/4"	SD320B7F	\$328	\$328		\$508
	Communicating	2-3/8"	SD392B6	\$208	\$218		\$388
		2-3/4"	SD392B7	\$208	\$218	N/A	\$388
		2-3/8"	SD392B6F	\$258	\$218		\$438
		2-3/4"	SD392B7F	\$258	\$218		\$438

HD Deadbolts

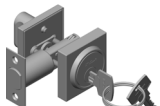
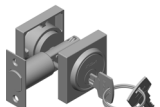
2-1/16" Square Solid Casted Escutcheon

				Finish			
				32D	32, 10B	PVD4	CeraMax ¹
Image	Function	Backset	Item No.	Price			
	Single Cylinder	2-3/8"	HD310B6	\$198	\$208		\$378
		2-3/4"	HD310B7	\$198	\$208	N/A	\$378
		2-3/8"	HD310B6F	\$248	\$258		\$428
		2-3/4"	HD310B7F	\$248	\$258		\$428
	Double Cylinder	2-3/8"	HD320B6	\$248	\$258		\$428
		2-3/4"	HD320B7	\$248	\$258	N/A	\$428
		2-3/8"	HD320B6F	\$298	\$308		\$478
		2-3/4"	HD320B7F	\$298	\$308		\$478
	Communicating	2-3/8"	HD392B6	\$178	\$188		\$358
		2-3/4"	HD392B7	\$178	\$188	N/A	\$358
		2-3/8"	HD392B6F	\$228	\$238		\$408
		2-3/4"	HD392B7F	\$228	\$238		\$408

For split finish between outside and inside, use higher item price with \$30 upcharge

Deadbolts and Privacy Bolts Parts and Services

Thick Door Kits (TDKs), Thin Door Kits (TDKs)

Thick Door Kits

Door Thickness	Function	Item Code	Price
CD/LD Deadbolt TDKs			
2"	Double Cylinder	TDK-DB2DC	\$31
	Single Cylinder	TDK-DB2214SC-T2	\$31
	Communicating	TDK-DB2CM	\$31
2-1/4"	Double Cylinder	TDK-DB214DC-T2	\$31
	Single Cylinder	TDK-DB2214SC-T2	\$31
	Communicating	TDK-DB214CM-T2	\$31
2-1/2"	Double Cylinder	TDK-DB212DC	\$31
	Single Cylinder	TDK-DB212234SC-T2	\$31
	Communicating	TDK-DB212CM-T2	\$31
2-3/4"	Double Cylinder	TDK-DB234DC	\$31
	Single Cylinder	TDK-DB212234SC-T2	\$31
	Communicating	TDK-DB234CM	\$31
3"	Double Cylinder	TDK-DB3DC	\$31
	Single Cylinder	TDK-DB3SC	\$31
	Communicating	TDK-DB3CM	\$31

Finish		
32	32D	10B

Door Thickness	Function	Item Code	Price		
RD/SD/GD/HD Deadbolt TDKs					
2"	Double Cylinder	TDK-DB2DC	\$31	\$31	\$31
	Single Cylinder	TDK-DB2SC	\$31	\$31	\$31
	Communicating	TDK-DB2CM	\$31	\$31	\$31
2-1/4"	Double Cylinder	TDK-DB214DC	\$31	\$31	\$31
	Single Cylinder	TDK-DB214SC	\$31	\$31	\$31
	Communicating	TDK-DB214CM	\$31	\$31	\$31
2-1/2"	Double Cylinder	TDK-DB212DC	\$31	\$31	\$31
	Single Cylinder	TDK-DB212SC	\$31	\$31	\$31
	Communicating	TDK-DB212CM	\$31	\$31	\$31

Fixing Packs

RD/SD/GD/HD Deadbolt Fixing Packs				
1-3/4"	Single Cylinder	FP-DB134SC	\$10	
1-3/4"	Double Cylinder	FP-DB134DC	\$10	
1-3/4"	Communicating	FP-DB134CM	\$10	
CD/LD Deadbolt Fixing Packs				
1-3/4"	Single Cylinder	FP-DB134SC-T2	\$10	
1-3/4"	Double Cylinder	FP-DB134DC	\$10	
1-3/4"	Communicating	FP-DB134CM-T2	\$10	

Deadbolts and Privacy Bolts Parts and Services

Escutcheons, Thick Door Kits (TDKs)

Illustration	Function	Item Code	Finish			
			32D	32, 10B, 19G	PVD4	CeraMax
Deadbolt and Privacy Bolt Escutcheons RD/SD/GD/CD/LD/HD						
	RD outside deadbolt escutcheon	ECIXR10	\$61	\$68	\$78	\$131
	RD inside deadbolt escutcheon w/thumbturn	ECIXR11	\$68	\$75	\$85	\$138
	RD outside communicating escutcheon	ECIXR14	\$61	\$68	\$78	\$131
	SD outside deadbolt escutcheon	ECIXS30	\$61	\$68	\$78	\$131
	SD inside deadbolt escutcheon w/thumbturn	ECIXS31	\$61	\$68	\$78	\$131
	SD outside communicating escutcheon	ECIXS34	\$68	\$75	\$85	\$138
	GD outside deadbolt escutcheon	ECIXG10	\$61	\$68	\$78	\$131
	GD inside deadbolt escutcheon w/thumbturn	ECIXG11	\$68	\$75	\$85	\$138
	GD outside communicating escutcheon	ECIXG14	\$61	\$68	\$78	\$131
	CD outside deadbolt escutcheon	ECIXC10	\$61	\$68	\$78	\$131
	CD inside deadbolt escutcheon w/thumbturn	ECIXC11	\$61	\$68	\$78	\$131
	LD outside deadbolt escutcheon	ECIXL30	\$38	\$43	\$43	\$85
	LD inside deadbolt escutcheon w/thumbturn	ECIXL31	\$61	\$68	\$78	\$131
	HD outside deadbolt escutcheon	ECIXH30	\$61	\$68	\$78	\$131
	HD inside deadbolt escutcheon w/thumbturn	ECIXH31	\$61	\$68	\$78	\$131
	HD outside communicating escutcheon	ECIXH34	\$61	\$68	\$78	\$131

Thin Door Kits (TDKs) RD/SD/GD/CD/LD/HD

	1-3/8" Door Thickness for RD deadbolt	ECIXR20	\$68	\$78	\$88	\$138
	1-3/8" Door Thickness for SD deadbolt	ECIXS40	\$68	\$78	\$88	\$138
	1-3/8" Door Thickness for GD deadbolt	ECIXG20	\$68	\$78	\$88	\$138
	1-3/8" Door Thickness for HD deadbolt	ECIXH40	\$68	\$78	\$88	\$138
	1-3/8" Door Thickness for CD deadbolt	ECIXC20	\$68	\$78	\$88	\$138
	1-3/8" Door Thickness for LD deadbolt	ECIXL40	\$68	\$78	\$88	\$138

Deadbolts and Privacy Bolts Parts and Services

Escutcheons, Thick Door Kits (TDKs)

Privacy Bolt Escutcheons

GT/GS/GR/SR

Finish			
32D	32, 10B, 19G	PVD4	CGY, CDB, C19G, C19

	Illustration	Function	Item Code	Price			
				32D	32, 10B, 19G	PVD4	CGY, CDB, C19G, C19
GT		GT Inside w/TT04	EC-GT-TT04	\$68	\$75	\$85	\$138
		GT Outside Less Cover	EC-GT-RLS	\$61	\$68	\$78	\$131
		GT Outside No Indicator	PR-GT-RCN	\$61	\$68	\$78	\$131
		GT Outside w/Indicator	PR-GT-RCW	\$61	\$68	\$78	\$131
GS		GS Inside w/TT04	EC-GS-TT04	\$68	\$75	\$85	\$138
		GS Outside Less Cover	EC-GS-RLS	\$61	\$68	\$78	\$131
		GS Outside No Indicator	PR-GS-RCN	\$61	\$68	\$78	\$131
		GS Outside w/Indicator	PR-GS-RCW	\$61	\$68	\$78	\$131
Replacement Parts		Thumbturn for Deadbolt	TT04	\$30	\$45	\$45	\$70
		Thumbturn for LA/SF/BP/MU	TT04C	\$30	\$45	\$45	\$70
		Thumbturn	TT02	\$30	\$45	\$45	\$70
		Thumbturn	TT07	\$30	\$45	\$45	\$70
		Gasket Washer for Deadbolt Thumbturn	AP-SJ-37	\$5	N/A	N/A	N/A
		M6x7mm Set Screws for Thumbturn	JG-10	\$5	N/A	N/A	N/A

LIST PRICES Deadbolts - Parts & Services

Parts and Services

Common Screws, Spindles and Parts

Spindles

Illustration	Description	Item No.	List (EA)
	Spindle square 8 x 8 x 45mm (For Standard Door Thickness)	FC-SP8845	\$11
	Spindle square 8 x 8 x 55mm (For 2" to 2-1/4" Door Thickness)	FC-SP8855	\$11
	Spindle square 8 x 8 x 65mm (For 2-1/2" to 2-3/4" Door Thickness)	FC-SP8865	\$11
	Spindle square 8 x 8 x 70mm (For 3" Door Thickness)	FC-SP8870	\$20

Common Screws and Parts

Illustration	Screw Type	Application	Item Code	List
	Combo Screws - Wood #8 and Machine M4x20mm	For TL2, TL4 Faceplate	FS-CBM4W8x20-PHL-FINISH	\$11
	Combo Screws - Wood #8 and Machine M4x30mm	For Full Lip Strike, T-Strike	FS-CBM4W8x30-PHL-FINISH	\$11
	Combo Screws - Wood #12 and Machine M12x20mm	For ASA Strike, Mortise Strike Plates, Mortise Lock Inner Faceplate	FS-CBM12W12x20-PHL-FINISH	\$11
	Wood Screws #8 x 1"	Wood Screws for RA/SE Dummy	FS-WS8X1-PHL-FINISH	\$11
	Wood Screws #10 x 1"	Wood Screws for LA/SF Dummy	FS-WS10X1-PHL-FINISH	\$11
	Machine Screws M4x6mm	For MC& MT Mortise Lock Amore Faceplate	FS-M4x6-PHL	\$11
	Machine Screws M4x35mm	All Tubular Levers Sectional Mortise Lever	FS-M4x35-PHL	\$11
	Machine Screws M5x45mm	RD/SD/GD Deadbolt Cylinder	FS-M5x45-PHL	\$11
	Machine Screws M5x50mm	LA/SF Entry Cylinder	FS-M5x50-PHL-2PK	\$11
	Machine Screws M6x45mm	LA/SF Mortise All Functions	FS-M6x45-PHL	\$11
	Bolt Sleeves M4x40mm	All Tubular Levers & Sectional Mortise Lever	FS-SLM4x40-OHX	\$11
	Bolt Sleeves M5x16mm	BP/MU Multipoint Trim	FS-SLM5x16-OHX	\$11
	Bolt Sleeves M6x30mm	LA/SF Mortise Sets	FS-SLM6x30-PHL	\$11
	Set Screws M6x5mm	Set Screws for levers and thumbturns	FS-JG-20	\$11
	Allen wrench	All Lever Sets	LJ-04	\$11
	Privacy Pin 4x38mm	For TL2 and TL4 Privacy Latch	PPMX4-TL-FINISH-10PK	\$50
	Emergency Release Key	Tubular Privacy Sets	ERK60-ZK	\$11



















Above common screws and parts are often lost or accidentally discarded during project installation. We recommend distributors keep a small stock of replacement service items on hand for convenience.

For more details of complete fixing packs, please see Standard Fixing Pack and Thick Door Kits Section.

HOW TO ORDER

MC7000 Mortise Locks with X Series Levers for Swing Doors

To order locksets, please describe the additional requirements in the same sequence as below. Parts or service upcharges may apply.

Rose	Lever	Lock	Function	Cylinder	Thumbturn	Finish	Handing
XGT	243	MC70	50			-32D	-LH
1	2	3	4	5	6	7	8
ROSE	LEVER	LOCK		FUNCTION			
 XGT  XGS  XRA  XSE	 201  202  205  221  243  244  276  318  319  320  321  345  346  509	70 no deadbolt 71 dummy trim 74 with deadbolt	10 Passage 40 Privacy 53 Entry with Toggle 50 Entry 38 Entry w/o Toggle 80 Storeroom 70 Classroom MDP Mortise Dummy Pair				

5 CYLINDER AND HOUSING (includes collar)

LC = Less Cylinder



Blank = Standard Mortise 1-1/4" Cylinder



-S6 = Small Format Interchangeable Cylinder (SFIC) Housing 1-1/4", 6-Pin, Less Core, L Clover Cam

-S7 = Small Format Interchangeable Cylinder (SFIC) Housing 1-3/8", 7-Pin, Less Core, L Clover Cam

-L6 = Large Format Interchangeable Cylinder (LFIC) Housing 1-1/2", 6-Pin, Less Core, L Clover Cam



Order IC Cores and Thick Door Kits (TDKs) separately

6 THUMBTURN



GR02
GT02
GS02
SR02



Blank = GR04
GT04
GS04
SR04



GR07
GT07
GS07
SR07



7 FINISH

Standard:



-32D



-C19G



-C19



-CGY



-CDB



-32



-PVD4



-19G



-CBB

8 HANDING

-RH = Right Hand













-LH = Left Hand

-RHR = Right Hand Reverse

-LHR = Left Hand Reverse

ANSI Grade 1 MC7000 Mortise with X Series Lever

X Series

					Finish			
					32D	32, 19G	PVD4 ¹	CeraMax ¹
Rose	Lever Design	Function	Backset	Price				
 XRA round rose 2-1/2" diameter  XSE square rose 2-9/16" x 2-9/16"  XGT round rose 2-1/16" diameter  XGS square rose 2-3/16" x 2-3/16"	201 Cologne 202 Munich 205 Frankfurt ¹ 221 Aurora ¹ 243 Sunrise ¹ 244 Twilight ¹ 276 Plaza ¹ 318 Café ¹ 319 Hampton ¹ 320 Empire ¹ 321 Valencia ¹ 345 Tokyo ¹ 346 Osaka ¹ 509 Stuttgart ¹	MC7010 Passage 	2-3/4"	\$558	\$578	\$608	\$748	
		MC7040 Privacy 	2-3/4"	\$578	\$598	\$628	\$768	
		MC7080 Storeroom 	2-3/4"	\$608	\$628	\$658	\$798	
		MC7070 Classroom 	2-3/4"	\$608	\$628	\$658	\$798	
		MC7050 Office and Inner Entry 	2-3/4"	\$608	\$628	\$658	\$798	
		MC7053 Entrance with Toggle no deadbolt 	2-3/4"	\$608	\$628	\$658	\$798	
		MC7438 Entrance without Toggle 	2-3/4"	\$608	\$628	\$658	\$798	
		MC7453 Entrance with Toggle & Deadbolt 	2-3/4"	\$608	\$628	\$658	\$798	
		MDP Dummy Pair without Lockcase 	2-3/4"	\$358	\$378	\$408	\$548	

¹ Finish Option

CeraMax Standard Finishes: C19G Graphite Black, C19 Flat Black, CGY Stormy Grey, CDB Dark Bronze, and CBB Burnt Bronze.

PVD4 finish available in 201, 205, 243, 276, 319, 320, 321, 345 and 346 lever design.

19G finish available 205, 243, 276, 318, 319, 320, 321, 345 and 346 lever design.



































Thick Door Kits (TDKs) are available. All cylinders are keyed different for standard order. Other keying services available. Cylinders, Collars and reference guide available. For split finishes between outside and inside trim; please use the higher finish price with an upcharge of \$30.

Mortise Locksets can be ordered to lock (EL) or unlock (EU) electrically. For orders with LC (Less Cylinder), use list price minus \$50. For order with S6, S7 and L6 housing, use list price plus \$60. Thumbturns Options available.

HOW TO ORDER

MC7000 Mortise Locks with LA/SF Plates for Swing Doors

To order locksets, please describe the additional requirements in the same sequence as below. Parts or service upcharges may apply.

Rose	Lever	Lock	Function	Cylinder	Thumbturn	Indicator	Finish	Handing	
LA	243	MC70	50				-32D	-LH	
1	2	3	4	5	6	7	8	9	
ROSE	LEVER	LOCK				FUNCTION			
 LA SF	 101  106  211  223  311  318	 102  107  213  225  319	 103  108  214  226  320	 104  109  217  227  321	 105  210  221  243  344	70 No Deadbolt 71 Dummy Trim 74 With Deadbolt  244  345	10 Passage 40 Privacy 53 Entry with Toggle 50 Inner Entry 38 Entry w/o Toggle 80 Storeroom 70 Classroom MDP - Dummy Pair  251  346	 276  300  351  380	

5 CYLINDER AND HOUSING (includes collar)

LC = Less Cylinder



Blank = Standard Mortise 1-1/4" Cylinder



-S6 = Small Format Interchangeable Cylinder (SFIC) Housing 1-1/4", 6-Pin, Less Core, L Clover Cam

-S7 = Small Format Interchangeable Cylinder (SFIC) Housing 1-3/8", 7-Pin, Less Core, L Clover Cam

-L6 = Large Format Interchangeable Cylinder (LFIC) Housing 1-1/2", 6-Pin, Less Core, L Clover Cam



Order IC Cores and Thick Door Kits (TDKs) separately

6 THUMBTURN



7 INDICATOR

Blank = Without Indicator

-SW = Single Window

-DW = Dual Window

8 FINISH

Standard:



9 HANDING

-RH = Right Hand

-LH = Left Hand



-RHR = Right Hand Reverse

-LHR = Left Hand Reverse

ANSI Grade 1 MC7000 Mortise with LA/SF Plates

Interior Locksets for bedroom, office
Exterior Locksets for entrances

Finish			
32D	32, 19G ¹ 10B ¹ , SP ¹	PVD4 ¹	CeraMax ¹

Plate <i>with Higher Lever</i>	Lever Design Group A	Function	Function Code	Price			
 LA oval plate 10-1/2" x 2-1/2"  SF rectangular plate 10-1/2" x 2-1/2"	101 Cologne 102 Munich 103 Oslo 104 Brussels 105 Frankfurt ¹ 106 Copenhagen ¹ 107 Stockholm 108 Vienna ¹ 109 Stuttgart 213 Cabernet 226 Summer 380 Polaris Knob	Passage (F01)	MC7010	\$518	\$558	\$578	\$618
		Privacy (F22)	MC7040	\$528	\$578	\$598	\$638
		Office & Inner Entry (F04)	MC7050	\$558	\$608	\$628	\$748
		Entrance with Toggle, No deadbolt (F04)	MC7053	\$558	\$608	\$628	\$748
		Classroom (F05)	MC7070	\$558	\$608	\$628	\$748
		Storeroom (F07)	MC7080	\$558	\$608	\$628	\$748
		Entry without Toggle	MC7438	\$558	\$608	\$628	\$748
		Entry with Toggle (F20)	MC7453	\$558	\$608	\$628	\$748
		Dummy Pair	MDP	\$358	\$408	428	\$548

¹ **Finish Options**
 PVD4 finish available in SF only in the 101, 105 and 108 lever design.
 19G finish available in SF only in the 105 lever design.
 10B finish available in LA only in the 105 and 106 lever designs.
 SP is a two-tone stainless steel finish and available in the 108 lever design.
 32D finish is not available in the 108 lever design.



Thick Door Kits (TDKs) are available. All cylinders are keyed different for standard order. Other keying services available. Cylinders, Collars and reference guide available. For split finishes between outside and inside trim; please use the higher finish price with an upcharge of \$30. Mortise Locksets can be ordered to lock (EL) or unlock (EU) electrically. For orders with LC (Less Cylinder), use list price minus \$50. For order with S6, S7 and L6 housing, use list price plus \$60. Thumbturns Options available.

Mortise Locksets
LIST PRICES

ANSI Grade 1 MC7000 Mortise with LA/SF Plates

Interior Locksets for bedroom, office
Exterior Locksets for entrances

Finish			
32D	32, 19G ¹ 10B ¹ , SP ¹	PVD4 ¹	CeraMax ¹

Plate <i>with Higher Lever</i>	Lever Design Group B	Function	Function Code	Price			
 <p>LA oval plate 10-1/2" x 2-1/2"</p>  <p>SF rectangular plate 10-1/2" x 2-1/2"</p>	210 Air-stream ¹ 211 Breeze ¹ 214 Champagne ¹ 217 Horizon 221 Aurora ¹ 223 Phoenix 225 Waterfall 227 Stratus 243 Sunrise ¹ 244 Twilight 251 Sequoia ¹ 276 Plaza ¹ 300 Napa ¹ 311 Crest ¹ 318 Café ¹ 319 Hampton ¹ 320 Empire ¹ 321 Valencia ¹ 344 Ecco 345 Tokyo ¹ 346 Osaka 351 Toronto	Passage (F01)	MC7010	\$548	\$598	\$618	\$738
		Privacy (F22)	MC7040	\$558	\$608	\$628	\$748
		Inner Entry (F04)	MC7050	\$588	\$638	\$658	\$748
		Office, no deadbolt (F04)	MC7053	\$588	\$638	\$658	\$748
		Classroom (F05)	MC7070	\$588	\$638	\$658	\$748
		Storeroom (F07)	MC7080	\$588	\$638	\$658	\$748
		Entry w/o Toggle	MC7438	\$588	\$638	\$658	\$748
		Entry with Toggle (F20)	MC7453	\$588	\$638	\$658	\$748
		Dummy Pair	MDP	\$388	\$438	\$458	\$578

¹ Finish Options

PVD4 finish available in SF only in the 221, 243, 244, 276, 319, 320 and 345 lever designs.
 19G finish available in SF only in the 221, 243, 276, 300, 318, 319, 320, 321 and 345 lever designs.
 10B finish available in LA only in the 211, 214, 221, 243, 311, 318, and 345 lever designs.
 SP is a two-tone stainless steel finish and available in the 221, 223, and 251 lever designs.

Thick Door Kits (TDKs) are available. All cylinders are keyed different for standard order. Other keying services available. Cylinders, Collars and reference guide available. For split finishes between outside and inside trim; please use the higher finish price with an upcharge of \$30. Mortise Locksets can be ordered to lock (EL) or unlock (EU) electrically. For orders with LC (Less Cylinder), use list price minus \$50. For order with S6, S7 and L6 housing, use list price plus \$60. Thumbturns Options available.

ANSI Grade 1 MC7000 Mortise with SF Plate & Fan Indicator

					Finish					
					32D	32, 19G ¹ 10B ¹ , SP ¹	PVD4 ¹	CeraMax ¹		
Plate <i>with Higher Lever</i>	Lever Design Group A	Function	Function Code	Indicator	Price					
	101 Cologne 102 Munich 103 Oslo 104 Brussels 105 Frankfurt ¹ 106 Copenhagen ¹ 107 Stockholm 108 Vienna ¹ 109 Stuttgart 213 Cabernet 226 Summer 380 Polaris Knob	Entry (F04)	MC7050	-SW	\$568	\$618	\$628	\$758		
				-DW	\$578	\$628	\$638	\$768		
		Privacy (F22)	MC7096	-SW	\$578	\$628	\$638	\$768		
				-DW	\$588	\$638	\$648	\$778		
		Entry w/o Toggle	M7438	-SW	\$608	\$658	\$668	\$798		
				-DW	\$618	\$668	\$678	\$808		
				Classroom (F05)	MC7070	-SW	\$608	\$658	\$668	\$798
						-DW	\$618	\$668	\$678	\$808

¹ Finish Options

PVD4 finish available in SF only in the 101, 105 and 108 lever design.

19G finish available in SF only in the 105 lever design.

10B finish available in SF only in the 105 and 106 lever designs.

SP is a two-tone stainless steel finish and available in the 108 lever design.





32D finish is not available in the 108 lever design.

Thick Door Kits (TDKs) are available. All cylinders are keyed different for standard order. Other keying services available. Cylinders, Collars and reference guide available. For split finishes between outside and inside trim; please use the higher finish price with an upcharge of \$30.

Mortise Locksets can be ordered to lock (EL) or unlock (EU) electrically. For orders with LC (Less Cylinder), use list price minus \$50. For order with S6, S7 and L6 housing, use list price plus \$60. Thumbturns Options available.

**ANSI Grade 1 MC7000 Mortise
with SF Plate & Fan Indicator**

Finish			
32D	32, 19G ¹ 10B ¹ , SP ¹	PVD4 ¹	CeraMax ¹

Plate <i>with Higher Lever</i>	Lever Design Group B	Function	Function Code	Indicator	Price					
					32D	32, 19G ¹ 10B ¹ , SP ¹	PVD4 ¹	CeraMax ¹		
	210 Air-stream ¹ 211 Breeze ¹ 214 Champagne ¹ 217 Horizon 221 Aurora ¹	Entry (F04)	MC7050	-SW	\$598	\$648	\$658	\$788		
				-DW	\$608	\$658	\$668	\$798		
			223 Phoenix 225 Waterfall 227 Stratus 243 Sunrise ¹ 244 Twilight 251 Sequoia ¹	Privacy (F22)	MC7096	-SW	\$608	\$658	\$668	\$798
						-DW	\$618	\$668	\$678	\$808
					276 Plaza ¹ 300 Napa ¹ 311 Crest ¹ 318 Café ¹ 319 Hampton ¹ 320 Empire ¹	Entry without Toggle	MC7438	-SW	\$638	\$688
-DW	\$648	\$698	\$708					\$838		
	321 Valencia ¹ 344 Ecco 345 Tokyo ¹ 346 Osaka 351 Toronto	Classroom (F05)	MC7070	-SW	\$638	\$688	\$698	\$828		
				-DW	\$648	\$698	\$708	\$838		

¹ Finish Options
 PVD4 finish available in SF only in the 221, 243, 244, 276, 318, 319, 320 and 345 lever designs.
 19G finish available in SF only in the 221, 243, 276, 300, 318, 319, 320, 321 and 345 lever designs.
 10B finish available in LA only in the 211, 214, 221, 243, 311, 318, and 345 lever designs.
 SP is a two-tone stainless steel finish and available in the 221, 223 and 251 lever designs.

Thick Door Kits (TDKs) are available. All cylinders are keyed different for standard order. Other keying services available. Cylinders, Collars and reference guide available. For split finishes between outside and inside trim; please use the higher finish price with an upcharge of \$30. Mortise Locksets can be ordered to lock (EL) or unlock (EU) electrically. For orders with LC (Less Cylinder), use list price minus \$50. For order with S6, S7 and L6 housing, use list price plus \$60. Thumbturns Options available.

SF Fan Indicator

LIST PRICES

Service Codes for Electrified Mortise Locksets (without deadbolt)

Description	Item No.	Price
SERVICE CODE: Electrification of Mortise Lock, Fail Safe 12V Voltage	SV-MC-EL12V	\$748
SERVICE CODE: Electrification of Mortise Lock, Fail Safe 24V Voltage	SV-MC-EL24V	\$748
SERVICE CODE: Electrification of Mortise Lock, Fail Secure 12V Voltage	SV-MC-EU12V	\$748
SERVICE CODE: Electrification of Mortise Lock, Fail Secure 24V Voltage	SV-MC-EU24V	\$748
SERVICE CODE: Electrification of Mortise Lock, Fail Safe 12V Voltage with REX Switch	SV-MC-EL12V-REX	\$748
SERVICE CODE: Electrification of Mortise Lock, Fail Safe 24V Voltage with REX Switch	SV-MC-EL24V-REX	\$748
SERVICE CODE: Electrification of Mortise Lock, Fail Secure 12V Voltage with REX Switch	SV-MC-EU12V-REX	\$748
SERVICE CODE: Electrification of Mortise Lock, Fail Secure 24V Voltage with REX Switch	SV-MC-EU24V-REX	\$748

Add service code and upcharge price as a separate line item to order electrified locking (EL) or electrified unlocking (EU) locks. In case of power outage, EL locks are Fail Safe and EU locks are Fail Secure.

Electrification Services are standard for MC7040 (Privacy) and MC7050 (Office) function.
For Electrification Services for MC7080 (Storeroom) please contact Sales/Account Manager for more information.

MC7000 Parts and Services

Rose Covers, Face Plates, Strikes, Thick Door Kits (TDKs), Thin Door Kits, (TDKs)

Thick Door Kits

Thick Door Kits (TDKs) accommodate a center door prep only. Does not include extended strike.

Finish		
32	32D	10B

Door Thickness	Function	Item Code	Price
X Series MC7000 Mortise Set TDKs			
2" to 2-1/4"	Passage	TDK-XMP2214-PS	\$64
	Privacy	TDK-XMP2214-PV	\$64
	Storeroom / Classroom	TDK-XMP2214-CS	\$121
	Entry	TDK-XMP2214-EN	\$121
2-1/2"	Passage	TDK-XMP212-PS	\$64
	Privacy	TDK-XMP212-PV	\$64
	Storeroom / Classroom	TDK-XMP212-CS	\$121
	Entry	TDK-XMP212-EN	\$121
2-3/4"	Passage	TDK-XMP234-PS	\$64
	Privacy	TDK-XMP234-PV	\$64
	Storeroom / Classroom	TDK-XMP234-CS	\$121
	Entry	TDK-XMP234-EN	\$121
3"	Passage	TDK-XMP3-PS	\$64
	Privacy	TDK-XMP3-PV	\$64
	Storeroom / Classroom	TDK-XMP3-CS	\$121
	Entry	TDK-XMP3-EN	\$121

Thick Door Kits

Finish		
32	32D	10B

Door Thickness	Function	Item Code	Price		
LA/SF MC7000 Mortise Set TDKs					
2" to 2-1/4"	Passage	TDK-PEM2214-PS	\$64	\$64	\$64
	Privacy	TDK-PEM2214-PV	\$64	\$64	\$64
	Storeroom / Classroom	TDK-PEM2214-CS	\$121	\$121	\$121
	Entry	TDK-PEM2214-EN	\$121	\$121	\$121
2-1/2"	Passage	TDK-PEM212-PS	\$64	\$64	\$64
	Privacy	TDK-PEM212-PV	\$64	\$64	\$64
	Storeroom / Classroom	TDK-PEM212-CS	\$121	\$121	\$121
	Entry	TDK-PEM212-EN	\$121	\$121	\$121
2-3/4"	Passage	TDK-PEM234-PS	\$64	\$64	\$64
	Privacy	TDK-PEM234-PV	\$64	\$64	\$64
	Storeroom / Classroom	TDK-PEM234-CS	\$121	\$121	\$121
	Entry	TDK-PEM234-EN	\$121	\$121	\$121
3"	Passage	TDK-PEM3-PS	\$64	\$64	\$64
	Privacy	TDK-PEM3-PV	\$64	\$64	\$64
	Storeroom / Classroom	TDK-PEM3-CS	\$121	\$121	\$121
	Entry	TDK-PEM3-EN	\$121	\$121	\$121

MC7000 Parts and Services

Rose Covers, Face Plates, Strikes, Thick Door Kits (TDKs), Thin Door Kits, (TDKs)









			Finish			
			32	32D, 19G	PVD4	CeraMax ¹
Rose Covers - XGT/XGS/XRA/XSE						
Illustration	Description	Item Code	Price (EA)			
	X Series GT Rose Interior	PR-XGT01-IS	\$30	\$36	\$44	\$100
	X Series GT Rose Exterior	PR-XGT01-OS	\$30	\$36	\$44	\$100
	X Series GS Rose Interior	PR-XGS01-IS	\$30	\$36	\$44	\$100
	X Series GS Rose Exterior	PR-XGS01-OS	\$30	\$36	\$44	\$100
	X Series RA Rose Interior	PR-XRA01-IS	\$38	\$45	\$55	\$108
	X Series RA Rose Exterior	PR-XRA01-OS	\$38	\$45	\$55	\$108
	X Series SE Rose Interior	PR-XSE01-IS	\$38	\$45	\$55	\$108
	X Series SE Rose Exterior	PR-XSE01-OS	\$38	\$45	\$55	\$108

			Finish			
			32D	32, 19G	PVD4	CGY, CDB C19G, C19
Faceplate and Strike						
Illustration	Function	Item Code	Price (EA)			
	Passage (MC701) Privacy (MC722)	MC-FSP01	\$19	\$25	\$33	\$89
	Classroom (MC705) Office/Inner Entry (MC705) Storeroom (MC707)	MC-FSP02	\$19	\$25	\$33	\$89
	Entry (MC720)	MC-FSP03	\$19	\$25	\$33	\$89
	Entry w/o Toggle (MC738)	MC-FSP05	\$19	\$25	\$33	\$89
	Faceplate for MC720 Mortise Deadlock	MC-FSP06	\$19	\$25	\$33	\$89
	Strike and Dustbox					
	MC Mortise Strike	LSR-MC01	\$19	\$25	\$33	\$89
	MC Mortise Strike Dust Box	LSR-DBX-MC	\$13	N/A	N/A	N/A
	Mortise Deadbolt Strike	LSR-MC720	\$19	\$25	\$33	\$89

MC7000 Parts and Services

Rose Covers, Face Plates, Strikes, Thick Door Kits (TDKs), Thin Door Kits, (TDKs)

Mortise LA/SF Cover Plates

Image		Function	Item Code	Finish			
				32D	32, 10B, 19G ¹	PVD4 ¹	CeraMax ¹
LA	SF		Price (EA)				
		Mortise Entry, Storeroom, Classroom Outside cover plate	PR-LA86 PR-SF86	\$30	\$36	\$44	\$150
		Mortise Entry, Privacy Inside cover plate	PR-LA87 PR-SF87	\$30	\$36	\$44	\$150
		Mortise Passage, Storeroom, Classroom, or Dummy - Inside or outside cover plate	PR-LA91 PR-SF91	\$30	\$36	\$44	\$150
		Mortise Privacy Outside cover plate	PR-LA92 PR-SF92	\$30	\$36	\$44	\$150
		Outside cover plate	PR-SF97	\$30	\$36	\$44	\$150
		Mortise Entry, Classroom, outside cover plate	PR-SF83	\$32	\$38	\$46	\$152
		Mortise Entry, Privacy, inside cover plate	PR-SF82	\$32	\$38	\$46	\$152
		Mortise Privacy, Classroom, outside cover plate	PR-SF84	\$32	\$38	\$46	\$152
		Mortise Classroom, inside cover plate	PR-SF85	\$32	\$38	\$46	\$152

Cover plates are not removable for pre-rose assembly lever designs and outside mortise privacy escutcheons (PD-LA92 and PE-SF92)









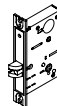

¹ Finish Options

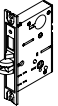
- PVD4 finish available in SF
- 19G finish available in SF

MC7000 Parts and Services

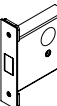
Rose Covers, Face Plates, Strikes, Thick Door Kits (TDKs), Thin Door Kits, (TDKs)

Lockcases

					Finish			
					32D	32, 19G	PVD4	CeraMax ¹
Illustration	Backset	Function	Item Code	Price (EA)				
 Passage  Privacy  Inner Entry	2-3/4"	Passage (7010)	MC701	\$274	\$288	\$302	\$344	
	2-3/4"	Privacy (7040/7044)	MC722 MC722NC	\$274	\$288	\$302	\$344	
	2-3/4"	Inner Entry w/o Deadbolt (7050)	MC704 MC704NC	\$288	\$300	\$314	\$358	
 Entry w/o Toggle  Entry w/ Toggle  Classroom	2-3/4"	Entry w/o Toggle (7438)	MC738 MC738NC	\$288	\$300	\$314	\$358	
	2-3/4"	Entry w/Toggle (7453)	MC720 MC720NC	\$315	\$327	\$341	\$385	
 Classroom  Classroom  Classroom	2-3/4"	Classroom (7070)	MC705 MC705NC	\$315	\$327	\$341	\$385	
	2-3/4"	Storeroom (7080)	MC707 MC707NC	\$315	\$327	\$341	\$385	
 Storeroom  Deadlock  MT Entry	2-3/4"	Deadlock	MC717	\$220	\$232	\$246	\$290	
	2-1/2"	Entry w/Toggle	MT620	\$315	\$327	\$341	\$385	
	2-3/4"	Entry w/Toggle	MT720	\$315	\$327	\$341	\$385	

NC- Non Clutch Mortise Lockcase

Fixing Packs

LA/SF MC7000 Mortise Set Fixing Packs			
1-3/4" For Lever Trim	All Functions / Privacy w/Bolt	FP-PEM01	\$19
1-3/8" and up	Dummy Pair	FP-DMY02	\$27
Dummy Latch Kits for Pre-Drilled Door Fixing Packs		Specify Finish: 32D/32/10B	
1-3/8" - 1-3/4"	Dummy	PPD-RSL6	\$48
1-3/8" - 1-3/4"	Dummy	PPD-RSL7	\$48

ANSI Grade 1 MS500 Mortise Deadbolt

	GR02	GR04	GR07	MS500	GT02	GT04	GT07	Finish	
								32D	10B, 19G
Description	Thumbturn			Function	Price				
Deadbolt - Single Cylinder with Thumbturn	GR02/GR04/GR07			MS560	\$358	\$378			
Deadbolt - Double Cylinder	-			MS562	\$408	\$428			
Deadbolt - Single Cylinder without Thumbturn	-			MS564	\$308	\$328			
Deadbolt - Thumbturn only	GR02/GR04/GR07			MS545	\$298	\$318			
Deadbolt - Thumbturn by Coin Turn Release	GR02/GR04/GR07			MS547	\$318	\$328			
Deadbolt - Thumbturn by Coin Turn Release and Indicator	GT02/GT04/GT07			MS546	\$328	\$338			

MS Series Grade 1 Small Deadbolt, 1-1/4"
Mortise Cylinder with Schlage L Cam Standard, 2-3/4" (70mm) Backset, ASA Strike
All cylinders are keyed different for standard order. Other keying service available.

Thick Door Kits

MS500 Mortise Deadbolt TDKs			
2"	Double Cylinder	TDK-DBM2DC	\$168
	Privacy	TDK-DBM2PV	\$33
2-1/2"	Double Cylinder	TDK-DBM212DC	\$168
	Single Cylinder	TDK-DBM212SC	\$114
	Privacy	TDK-DBM212PV	\$33
2-1/2" to 2-3/4"	Communicating	TDK-DBM212234CM	\$33
2-3/4"	Double Cylinder	TDK-DBM234DC	\$168
	Single Cylinder	TDK-DBM234SC	\$114
	Privacy	TDK-DBM234PV	\$33
3"	Double Cylinder	TDK-DBM3DC	\$168
	Single Cylinder	TDK-DBM3SC	\$114
	Privacy	TDK-DBM3PV	\$33
	Communicating	TDK-DBM3CM	\$33

HOW TO ORDER MORTISE DEADBOLT

Example: Mortise Deadbolt single cylinder with GR04 thumbturn, Satin Stainless Steel, IC Core Cylinder, Keyed Alike

Thumbturn	Lock	Function	Finish	Cylinder	Keying
GR04	MS5	60	32D	IC	KA

Cylinders

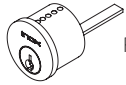

Rim Cylinder

Description	Cylinder Type	Size	Cylinder Code	Finish			
				32D	32 ³ ,19G	PVD4 ³	CeraMax ¹
Rim Cylinders Schlage C Keyway, 5 Pin with Tailpiece, 2 Keys Standard: Keyed Differently (KD)	Single	1"	CRB105	\$52	\$59	\$66	\$162
	Double	1"	CRB105DB	\$104	\$118	\$132	\$214
	Tubular Dummy	1"	CRA 10D	\$52	\$59	\$66	\$162

³ Longer leadtimes and MOQ may apply, please check before ordering.



Mortise Cylinder

Description	Cylinder Type	Size	Cylinder Code	Finish			
				32D/26D ¹	32 ³ ,19G	PVD4 ³	CeraMax ¹
Mortise Cylinders Schlage C Keyway, 6 Pin with Clover L Cam, 2 Keys Standard: Keyed Differently (KD)	Mortise	15/16"	CMB0345	\$64	\$75	\$64	\$174
		1"	CMB105	\$64	\$75	\$64	\$174
		1-1/8"	CMB1186	\$70	\$82	\$70	\$180
		1-1/4"	CMB1146	\$70	\$82	\$70	\$180
		1-3/8"	CMB1386	\$76	\$88	\$76	\$186
		1-1/2"	CMB1126	\$76	\$88	\$76	\$186
		1-5/8"	CMB1586	\$82	\$94	\$82	\$192
		1-3/4"	CMB1346	\$82	\$94	\$82	\$192
	Mortise Dummy	1/2"	CMA10D	\$52	\$64	\$52	\$162

³ Longer leadtimes and MOQ may apply, please check before ordering.

Standard cylinder comes with Clover L Cam, for other Mortise Cams, use finish price plus \$10 upcharge

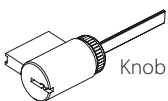

Knob Cylinder

Description	Tailpiece	Cylinder Code	Finish	
			26D	4
American Knob Cylinder Schlage C Keyway, 6 Pin, 2 Keys, 40mm Tailpiece	40mm	CYSC10	\$42	\$54

IC Core and Housing

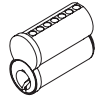

SFIC Core

Description	Cylinder Code	Finish		
		26D	19G	PVD4
IC Cylinder Core, 6 Pin, Best A Keyway Small Format, Combined	CMB-ICBA6-CMB⁴	\$92	\$106	\$98
IC Cylinder Core, 7 Pin, Best A Keyway Small Format, Combined	CMB-ICBA7-CMB	\$100	\$114	\$104
Construction Key available in 26D and also in RED and GRN painted faces, list desired finish when ordering				
IC Cylinder Core, 6 Pin, Best A Keyway Small Format, Construction Core <i>Two Keyed Alike (KA) and one Control Key, per Group of 10</i>	CMB-ICBA6-CST-FINISH	\$78	N/A	N/A
IC Cylinder Core, 7 Pin, Best A Keyway Small Format, Construction Core <i>Two Keyed Alike (KA) and one Control Key, per Group of 10</i>	CMB-ICBA7-CST-FINISH	\$85	N/A	N/A

⁴Black finish available on core - finish may not exactly match Black or Graphite Black finish







SFIC Housing

Description	Cylinder Code	Finish		
		26D, PVD4	19G	CeraMax
Mortise Cylinder ICBA Housing for 6 Pin, Less Core, 1-3/8"	CMB1386-ICBA-HUS	\$85	N/A	\$205
Mortise Cylinder SFIC Housing for 6 Pin, Less Core, 1-1/4"	CMB1146-ICBA-HUS	\$78	\$97	\$198
Mortise Cylinder SFIC Housing for 7 Pin, Less Core, 1-3/8"	CMB1387-ICBA-HUS	\$85	S/O	\$205
Mortise Cylinder LFIC Housing for 6 Pin, Less Core, 1-1/2"	CMB1126-LFIC-HUS	\$78	\$85	\$198
Mortise Cylinder SFIC Housing for 7 Pin, Less Core, 1-1/2"	CMB1127-ICBA-HUS	\$85	N/A	\$205

Cross Reference Chart for Cylinders and Collars by Trim

Item Code	Description	Trim	Collar Reference
CMB1126	1-1/2" Cylinder 6 Pin	XSF-MED	EC-R385COL Round Collar
CMB1186	1-1/8" Cylinder 6 Pin	SF / PD97	No Collar Required
		XSF-RIM	EC-R370COL Round Collar
CMB1146	1-1/4" Cylinder, 6 pin	ISM7000	No Collar Required
		XRA / XGT / ISMPD95	EC-R460COL Round Collar
		XSE / XGS	EC-S420COL Square Collar
		XSF-CVR	EC-R370COL Round Collar
CMB1386	1-3/8" Cylinder, 6 pin	TDKs	EC-R417COL Round Collar
			EC-S420COL + EC-R456COL Square Collar
CMB1126-ICBA-HUS	1-1/2" SFIC housing, 6 pin	XSF-MED	EC-R385COL Round Collar
CMB1146-ICBA-HUS	1-1/4" SFIC housing, 6 pin	XRA / XGT / ISMPD95	EC-R460COL Round Collar
		ISM7000	No Collar Required
		XSE / XGS	EC-S420COL Square Collar
		XSF-RIM / XSF-CVR	EC-R370COL Round Collar
		XSF-MED	EC-R385COL Round Collar
CMB1387-ICBA-HUS	1-3/8" SFIC housing, 7 pin	XRA / XGT / ISMPD95	EC-R417COL Round Collar
		ISM7000	No Collar Required
		XSE / XGS	EC-S420COL + EC-R456COL Square Collar
		SF / PD97	EC-R456COL Round Collar
CMB1126-LFIC-HUS	1-1/2" LFIC housing, 6 pin	XSF-MED	EC-R385COL Round Collar
		XRA / XGT / ISMPD95	EC-R417COL Round Collar
		XSE XGS	EC-S420COL + EC-R456COL Square Collar
		SF / PD97 / ISM7000	EC-R456COL Round Collar
		XSF-RIM / XSF-CVR	EC-R370COL Round Collar
CMB1127-ICBA-HUS	1-1/2" SFIC housing, 7 pin	XSF-RIM / XSF-CVR	EC-R370COL Round Collar
		XSF-MED	EC-R385COL Round Collar

Collars

			Finish				
			32D	32	10B	19G	CeraMax
Illustration	Function	Item Code	Price				
	Round Extended Collar for XRA/XGT 1-3/8 – 1-1/2" IC Mortise Cylinder	EC-R417COL	\$22	\$28	N/A	\$34	\$92
	Round Collar for LA/SF Entry or RA/GT Mortise Cylinder 1-1/4" Cylinder	EC-R460COL	\$16	\$22	\$24	N/A	\$86
	Square Collar for LA/SF Entry or SE/GS Mortise Cylinder 1-1/4" Cylinder	EC-S420COL⁵	\$22	\$28	\$34	N/A	\$92
	Round Collar for XSF Trim 1-1/8 – 1-1/2" Mortise Cylinder	EC-R370COL	\$28	\$34	N/A	N/A	\$98
	Universal Round Collar	EC-R456COL⁵	\$34	\$40	N/A	\$42	\$104

⁵ EC-R456COL must be paired with EC-S420COL when using Square XSE/XGS style Trim with 1-3/8 – 1-1/2" IC Cylinders. EC-R456COL can be used as a stand alone collar when using Round XRA/XGT style Trim with 1-3/8 – 1-1/2" IC Cylinders.

Keying Service Options

Service Code	Description	Price
SV-KYCT	Service: Key Cut including Key Blank	\$12 Per Key
SV-KA	Service: Keyed Alike (KA) - Each cylinder in the group is keyed alike 2 Keys per KA Group of 10 included	\$18 Per Cylinder
SV-KASN	Service: Keyed Alike Group (Specify Number of Keyed Alike Per Group) Each cylinder in the group is keyed alike 2 Keys per KA Group of 10 included	\$18 Per Cylinder
SV-KS	Service: Keyed to Specific Code - Cylinder is keyed to a specific code 2 keys per KS Group of 10 included	\$18 Per Cylinder
SV-MK	Service: Master Keying - 2 Change Keys per Cylinder and 3 Master Keys per MK Group of 10 included (CMK ordered separately if required)	\$28 Per Cylinder
SV-GMK	Service: Grand Master Keying (2 or more MK groups included), 2 Change Keys per Cylinder, 3 Grand Master Keys per GMK Group & 3 Master Keys per MK Group of 10 included. (CMK ordered separately if required)	\$32 Per Cylinder

All standard cylinders are keyed different for standard order.

Service Code	Description	Price
SV-ICKYCT	Service: IC Core Key Cut including Key Blank	\$23 Per Key
SV-ICKA	Service: IC Core Keyed Alike (KA) - Each cylinder in the group is keyed alike 2 Keys per KA Group of 10 included	\$32 Per Core
SV-ICKS	Service: IC Core Keyed to Specific Code - Cylinder is keyed to a specific code 2 keys per KS Group of 10 included	\$32 Per Core
SV-ICMK	Service: IC Core Master Keying - 2 Change Keys per Cylinder and 3 Master Keys per MK Group of 10 included (CMK ordered separately if required)	\$52 Per Core
SV-ICGMK	Service: IC Core Grand Master Keying (2 or more MK groups included), 2 Change Keys per Cylinder, 3 Grand Master Keys per GMK Group & 3 Master Keys per MK Group of 10 included. (CMK ordered separately if required)	\$58 Per Core

All IC Core are keyed different for standard order.

Service Code	Description	Price
SV-CYKYCT	Service: Euro Cylinder Key Cut including Key Blank	\$23 Per Key
SV-CYKA	Service: Euro Cylinder Keyed Alike (KA) - Each cylinder in the group is keyed alike 2 Keys per KA Group of 10 included	\$32 Per Cylinder
SV-CYKS	Service: Euro Cylinder Keyed to Specific Code - Cylinder is keyed to a specific code 2 keys per KS Group of 10 included	\$32 Per Cylinder
SV-CYMK	Service: Euro Cylinder Master Keying - 2 Change Keys per Cylinder and 3 Master Keys per MK Group of 10 included (CMK ordered separately if required)	\$52 Per Cylinder
SV-CYGMK	Service: Euro Cylinder Grand Master Keying (2 or more MK groups included), 2 Change Keys per Cylinder, 3 Grand Master Keys per GMK Group & 3 Master Keys per MK Group of 10 included (CMK ordered separately if required)	\$58 Per Cylinder

All Euro cylinders are keyed different for standard order.

Thumbturn Sets

Compatible with MC7000 Series Lockcases

Illustration	Item Code	Description	Finish				
			32D	32	10B, 19G	PVD4	CeraMax
			Price				
Round Rosette							
	EC-R460PVS-ADA	ADA Thumbturn TT07 & Privacy Release on D.46mm Round Rosette, no Indicator	\$90/set	\$95/set	\$100/set	\$105/set	\$160/set
	EC-R460PVS	TT04 Thumbturn & Privacy Release on D.46mm Round Rosette, no Indicator	\$80/set	\$85/set	\$90/set	\$95/set	\$150/set
	EC-R460PVS-TT02	TT02 Thumbturn & Privacy Release on D.46mm Round Rosette, no Indicator	\$80/set	\$85/set	N/A	N/A	\$150/set
	EC-R530PVSW-ADA	ADA Thumbturn TT07 & Privacy Release with Indicator on D.53mm Round Rosette *Special thumbturn door prep required*	\$105/set	\$120/set	N/A	\$120/set	\$175/set
	EC-R530PVSW	TT04 Thumbturn & Privacy Release with Indicator on D.53mm Round Rosette *Special thumbturn door prep required*	\$90/set	\$95/set	N/A	N/A	\$160/set
	EC-R530PVSW-TT02	TT02 Thumbturn & Privacy Release with Indicator on D.53mm Round Rosette *Special thumbturn door prep required*	\$90/set	\$95/set	N/A	N/A	\$160/set
Square Rosette							
	EC-S420PVS-ADA	ADA Thumbturn TT07 & Privacy Release on D.42mm Square Rosette, no Indicator	\$105/set	\$120/set	\$115/set	N/A	\$175/set
	EC-S420PVS	TT04 Thumbturn & Privacy Release on D.42mm Square Rosette, no Indicator	\$90/set	\$95/set	\$100/set	N/A	\$160/set
	EC-S420PVS-TT02	TT02 Thumbturn & Privacy Release on D.42mm Square Rosette, no Indicator	\$90/set	\$95/set	N/A	N/A	\$160/set
	EC-S530PVSW-ADA	ADA Thumbturn TT07 & Privacy Release with Indicator on D.53mm Square Rosette *Special thumbturn door prep required*	\$115/set	\$120/set	N/A	N/A	\$185/set
	EC-S530PVSW	TT04 Thumbturn & Privacy Release with Indicator on D.53mm Square Rosette *Special thumbturn door prep required*	\$105/set	\$120/set	N/A	N/A	\$175/set
	EC-S530PVSW-TT02	TT02 Thumbturn & Privacy Release with Indicator on D.53mm Square Rosette *Special thumbturn door prep required*	\$105/set	\$120/set	N/A	N/A	\$175/set

Thumbturns

— LIST PRICES

Thumbturn Only

Compatible with MC7000 Series Lockcases

				Finish				
				32D	32	10B, 19G	PVD4	CeraMax
Illustration	Item Code	Description	Price					
Round Rosette								
	EC-R460TT07-ADA	ADA Thumbturn TT07 on D.46mm Round Rosette	\$54	\$60	\$65	\$68	\$124	
	EC-R460TT04	Thumbturn TT04 on D.46mm Round Rosette	\$48	\$54	\$59	\$62	\$118	
	EC-R460TT02	Thumbturn TT02 on D.46mm Round Rosette	\$48	\$54	N/A	N/A	\$118	
	EC-R530TT07-ADA	ADA Thumbturn on D.53mm Round Rosette *Special thumbturn door prep required*	\$78	\$84	N/A	\$92	\$148	
	EC-R530TT04	Thumbturn TT04 on D.53mm Round Rosette *Special thumbturn door prep required*	\$60	\$66	N/A	N/A	\$130	
	EC-R530TT02	Thumbturn TT02 on D.53mm Round Rosette *Special thumbturn door prep required*	\$60	\$66	N/A	N/A	\$130	
Square Rosette								
	EC-S420TT07-ADA	ADA Thumbturn TT07 on D.42mm Square Rosette	\$79	\$85	\$90	N/A	\$149	
	EC-S420TT04	Thumbturn TT04 on D.42mm Square Rosette	\$60	\$66	\$71	N/A	\$130	
	EC-S420TT02	Thumbturn TT02 on D.42mm Square Rosette	\$60	\$66	N/A	N/A	\$130	
	EC-S530TT07-ADA	ADA Thumbturn on D.53mm Square Rosette *Special thumbturn door prep required*	\$78	\$84	N/A	N/A	\$148	
	EC-S530TT04	Thumbturn TT04 on D.53mm Square Rosette *Special thumbturn door prep required*	\$72	\$78	N/A	N/A	\$142	
	EC-S530TT02	Thumbturn TT02 on D.53mm Square Rosette *Special thumbturn door prep required*	\$72	\$78	N/A	N/A	\$142	

Euro Profile Cylinders and Half Cylinders

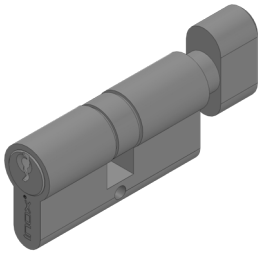
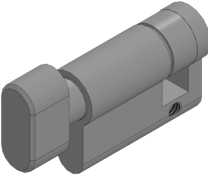
Cylinders	Size Overall (L)	Size Split (A/B)	Item Code	Finish		
				15	10B, 26, 19G, 4	CGY, CDB, C19G, C19
				Price		
 <p>Euro Profile Cylinders Keyed and Thumbturn Schlage C Keyway, 5 Pin 3 Keys M5x80 Breakable Screw</p>	70mm	35/35mm	CYEU-3535TK	\$76	\$91	\$236
	80mm	40/40mm	CYEU-4040TK	\$76	\$91	\$236
	85mm	35/50mm 50/35mm 30/55mm 55/30mm	CYEU-3550TK CYEU-5035TK CYEU-3055TK CYEU-5530TK	\$76	\$91	\$236
	90mm	45/45mm	CYEU-4545TK	\$76	\$91	\$236
	100mm	50/50mm	CYEU-5050TK	\$76	\$91	\$236
 <p>Euro Profile Half Cylinders Thumbturn only M5x80 Breakable Screw</p>	45mm	10/35mm	CYEU-1035TK	\$76	\$91	\$236
	50mm	10/40mm	CYEU-1040TK	\$76	\$91	\$236
	55mm	10/45mm	CYEU-1045TK	\$76	\$91	\$236
	60mm	10/50mm	CYEU-1050TK	\$76	\$91	\$236
	65mm	10/55mm	CYEU-1055TK	\$76	\$91	\$236

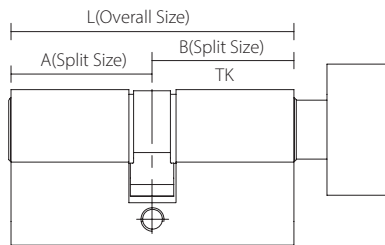
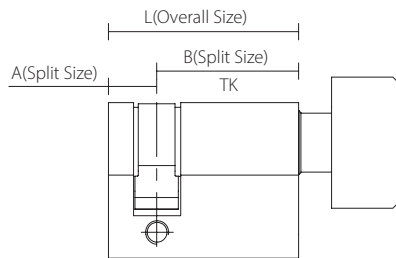

ADA Surface Pulls

Interior / Exterior Pull



Image	Length	CTC	Tube Dia.	Fixing	Item Code	Finish				
						32D	32	19G	PVD4, 26D	CeraMax
	8"	5"	7/8"	Bolt-Thru	PHIX330.512.8 BT	\$98	\$108	\$113	\$113	\$228
				Back-to-Back	PHIX330.512.8 BTB	\$157	\$173	\$188	\$214	\$417
				Self-Tapping	PHIX330.512.8 ST	\$98	\$108	\$113	\$113	\$228

Image	Length	CTC	Tube Dia.	Fixing	Item Code	Finish				
						32D	32	19G	10B	CeraMax
	8-3/4"	8"	3/4"	Bolt-Thru	PHIX31108 BT	\$74	\$82	\$95	N/A	\$204
				Back-to-Back	PHIX31108 BTB	\$113	\$124	\$152	N/A	\$373
				Self-Tapping	PHIX31108 ST	\$74	\$82	\$95	N/A	\$204
	8-3/4"	8"	3/4"	Bolt-Thru	PHIX30108 BT	\$79	\$85	\$98	N/A	\$209
				Back-to-Back	PHIX30108 BTB	\$118	\$131	\$157	N/A	\$378
				Self-Tapping	PHIX30108 ST	\$79	\$85	\$98	N/A	\$209
	8-1/4"	7-1/4"	7/8"	Bolt-Thru	PHIX41714 BT	\$147	\$157	\$178	N/A	\$277
				Back-to-Back	PHIX41714 BTB	\$256	\$282	\$321	N/A	\$503
				Self-Tapping	PHIX41714 ST	\$147	\$157	\$178	N/A	\$407
	7-3/4"	7-1/4"	7/8"	Bolt-Thru	PHIX45714 BT	\$147	\$157	\$178	N/A	\$277
				Back-to-Back	PHIX45714 BTB	\$256	\$282	\$321	N/A	\$503
				Self-Tapping	PHIX45714 ST	\$147	\$157	\$178	N/A	\$407

Surface Pulls

Interior / Exterior Pull

Image	Length	CTC	Tube Dia.	Fixing	Item Code	Finish		
						32D	32	CeraMax
						Price		
	6-3/4"	6"	3/4"	Bolt-Thru	PHIX31106 BT	\$73	\$82	\$203
				Back-to-Back	PHIX31106 BTB	\$112	\$131	\$372
				On Roses	PHIX31106 OR	\$77	\$86	\$207
				Self-Tapping	PHIX31106 ST	\$73	\$82	\$203
	8-3/4"	8"	3/4"	Bolt-Thru	PHIX31108 BT	\$78	\$87	\$208
				Back-to-Back	PHIX31108 BTB	\$117	\$128	\$277
				Self-Tapping	PHIX31108 ST	\$78	\$87	\$208
	10-3/4"	10"	3/4"	Bolt-Thru	PHIX31110 BT	\$64	\$69	\$214
				Back-to-Back	PHIX31110 BTB	\$98	\$111	\$398
				On Roses	PHIX31110 OR	\$67	\$72	\$217
				Self-Tapping	PHIX31110 ST	\$64	\$69	\$214
	12-3/4"	12"	3/4"	Bolt-Thru	PHIX31112 BT	\$66	\$87	\$216
				Back-to-Back	PHIX31112 BTB	\$105	\$118	\$405
				On Roses	PHIX31112 OR	\$69	\$91	\$153
				Self-Tapping	PHIX31112 ST	\$66	\$87	\$216
	16-3/4"	16"	3/4"	Bolt-Thru	PHIX311.16.1675 BT	\$92	N/A	\$224
				Back-to-Back	PHIX311.16.1675 BTB	\$131	N/A	\$431
				Self-Tapping	PHIX311.16.1675 ST	\$92	N/A	\$224
	18-3/4"	18"	3/4"	Bolt-Thru	PHIX311.18.1875 BT	\$100	N/A	\$250
				Back-to-Back	PHIX311.18.1875 BTB	\$139	N/A	\$439
				Self-Tapping	PHIX311.18.1875 ST	\$100	N/A	\$250
	11"	10"	1"	Bolt-Thru	PHIX31210 BT	\$74	\$79	\$224
				Back-to-Back	PHIX31210 BTB	\$139	\$131	\$439
				Self-Tapping	PHIX31210 ST	\$74	\$79	\$224
13"	12"	1"	Bolt-Thru	PHIX31212 BT	\$90	\$98	\$240	
			Back-to-Back	PHIX31212 BTB	\$157	\$183	\$457	
			Self-Tapping	PHIX31212 ST	\$90	\$98	\$240	
13-1/4"	12"	1-1/4"	Bolt-Thru	PHIX31312 BT	\$116	\$129	\$266	
			Back-to-Back	PHIX31312 BTB	\$225	\$251	\$525	
			Self-Tapping	PHIX31312 ST	\$116	\$129	\$266	
19-1/4"	18"	1-1/4"	Bolt-Thru	PHIX31318 BT	\$139	\$160	\$289	
			Back-to-Back	PHIX31318 BTB	\$286	\$326	\$586	
			Self-Tapping	PHIX31318 ST	\$139	\$160	\$289	

Bolt-Thru consists of 1 single pull + 1 Bolt-Thru fixing pack (function code: BT)
 Back-to-Back consists of 2 single pulls + 1 Back-to-Back fixing pack (function code: BTB)
 On rosette consists of 1 single pull + 1 On roses fixing pack (function code: OR)
 For fixing pack, see pages 237-239.

Surface Pulls

Interior / Exterior Pull

						Finish		
						32D	32	CeraMax
Image	Length	CTC	Tube Dia.	Fixing	Item Code	Price		
	11"	10"	1"	Bolt-Thru	PHIX32210 BT	\$120	\$137	\$270
				Back-to-Back	PHIX32210 BTB	\$235	\$264	\$535
				Self-Tapping	PHIX32210 ST	\$120	\$137	\$270
	13"	12"	1"	Bolt-Thru	PHIX32212 BT	\$129	\$144	\$279
				Back-to-Back	PHIX32212 BTB	\$254	\$290	\$554
				Self-Tapping	PHIX32212 ST	\$129	\$144	\$279
	13-1/4"	12"	1-1/4"	Bolt-Thru	PHIX32312 BT	\$160	\$178	\$310
				Back-to-Back	PHIX32312 BTB	\$321	\$358	\$621
				Self-Tapping	PHIX32312 ST	\$160	\$178	\$310
	19-1/4"	18"	1-1/4"	Bolt-Thru	PHIX32318 BT	\$196	\$217	\$346
				Back-to-Back	PHIX32318 BTB	\$406	\$447	\$706
				Self-Tapping	PHIX32318 ST	\$196	\$217	\$346

Bolt-Thru consists of 1 single pull + 1 Bolt-Thru fixing pack (function code: BT)

Back-to-Back consists of 2 single pulls + 1 Back-to-Back fixing pack (function code: BTB)

Surface Pulls



Interior / Exterior Pull

Image	Length	CTC	Tube Dia.	Fixing	Item Code	Finish		
						32D	32	CeraMax
						Price		
 <p>T2 Style Pull</p>	16"	12"	1"	Bolt-Thru	PHIX33212 BT	\$157	N/A	\$307
				Back-to-Back	PHIX33212 BTB	\$259	N/A	\$559
	16"	10"	1"	Bolt-Thru	PHIX332.10.16 BT	\$147	N/A	\$297
				Back-to-Back	PHIX332.10.16 BTB	\$238	N/A	\$538
	18"	10"	1-1/4"	Bolt-Thru	PHIX33310 BT	\$124	\$134	\$274
				Back-to-Back	PHIX33310 BTB	\$217	\$243	\$517
	20"	12"	1-1/4"	Bolt-Thru	PHIX33312 BT	\$131	\$147	\$261
				Back-to-Back	PHIX33312 BTB	\$238	\$269	\$538
	26"	18"	1-1/4"	Bolt-Thru	PHIX33318 BT	\$144	\$163	\$294
				Back-to-Back	PHIX33318 BTB	\$267	\$303	\$567
	36"	33-1/4"	1-1/4"	Bolt-Thru	PHIX333.3325.36 BT	\$199	N/A	\$479
				Back-to-Back	PHIX333.3325.36 BTB	\$347	N/A	\$907
	48"	45-1/4"	1-1/4"	Bolt-Thru	PHIX333.4525.48 BT	\$244	N/A	\$674
				Back-to-Back	PHIX333.4525.48 BTB	\$429	N/A	\$1,389
	56"	48"	1-1/4"	Bolt-Thru	PHIX33348 BT	\$403	N/A	\$983
				Back-to-Back	PHIX33348 BTB	\$728	N/A	\$1,888
	68"	60"	1-1/4"	Bolt-Thru	PHIX33360 BT	\$468	N/A	\$1,048
				Back-to-Back	PHIX33360 BTB	\$858	N/A	\$2,018
72"	64"	1-1/4"	Bolt-Thru	PHIX33364 BT	\$598	N/A	\$1,288	
			Back-to-Back	PHIX33364 BTB	\$1,118	N/A	\$2,498	

Bolt-Thru consists of 1 single pull + 1 Bolt-Thru fixing pack (function code: BT)
 Back-to-Back consists of 2 single pulls + 1 Back-to-Back fixing pack (function code: BTB)
 For fixing pack see pages 237-239.

Surface Pulls

Interior / Exterior Pull

						Finish			
						32D	32	CeraMax	
Image	Length	CTC	Tube Dia.	Fixing	Item Code	Price			
 <p>90°</p>	12"	9-1/2"	7/8"	Bolt-Thru	PHIX330.912.12 BT	\$147	N/A	\$297	
				Back-to-Back	PHIX330.912.12 BTB	\$215	N/A	\$515	
	16"	13-1/2"	7/8"	Bolt-Thru	PHIX330.1312.16 BT	\$120	N/A	\$260	
				Back-to-Back	PHIX330.1312.16 BTB	\$191	N/A	\$491	
	18"	15-1/2"	7/8"	Bolt-Thru	PHIX330.1512.18 BT	\$120	N/A	\$260	
				Back-to-Back	PHIX330.1512.18 BTB	\$191	N/A	\$491	
	16"	13-1/4"	1-1/4"	Bolt-Thru	PHIX333.1325.16 BT	\$131	N/A	\$281	
				Back-to-Back	PHIX333.1325.16 BTB	\$199	N/A	\$499	
	18"	15-1/4"	1-1/4"	Bolt-Thru	PHIX333.1525.18 BT	\$144	N/A	\$294	
				Back-to-Back	PHIX333.1525.18 BTB	\$212	N/A	\$512	
	 <p>45°</p>	18"	10"	1-1/4"	Bolt-Thru	PHIX34310 BT	\$163	\$178	\$313
					Back-to-Back	PHIX34310 BTB	\$269	\$303	\$569
Self-Tapping					PHIX34310 ST	\$163	\$178	\$313	
20"		12"	1-1/4"	Bolt-Thru	PHIX34312 BT	\$176	\$194	\$326	
				Back-to-Back	PHIX34312 BTB	\$295	\$334	\$595	
				Self-Tapping	PHIX34312 ST	\$176	\$194	\$326	
26"		18"	1-1/4"	Bolt-Thru	PHIX34318 BT	\$222	\$241	\$326	
				Back-to-Back	PHIX34318 BTB	\$386	\$420	\$686	
				Self-Tapping	PHIX34318 ST	\$222	\$241	\$326	

Bolt-Thru consists of 1 single pull + 1 Bolt-Thru fixing pack (function code: BT)



Back-to-Back consists of 2 single pulls + 1 Back-to-Back fixing pack (function code: BTB)

For fixing packsee pages 237-239.

					Finish		
					32D	32	CeraMax
Image	Description	Item Code	Price				
T2 Style Pull	Single Post for T-Shape Pulls	PHIX-PT45	\$43	\$47	\$113		

Surface Pulls

Interior / Exterior Pull

						Finish		
						32D	32, 19G	CeraMax
Image	Length	CTC	Tube Dia.	Fixing	Item Code	Price		
	8-3/4"	8"	3/4"	Bolt-Thru	PHIX301.8.875 BT	\$66	N/A	\$196
				Back-to-Back	PHIX301.8.875 BTB	\$105	N/A	\$365
				Self-Tapping	PHIX301.8.875 ST	\$66	N/A	\$196
	16-3/4"	16"	3/4"	Bolt-Thru	PHIX301.16.1675 BT	\$101	N/A	\$251
				Back-to-Back	PHIX301.16.1675 BTB	\$150	N/A	\$450
				Self-Tapping	PHIX301.16.1675 ST	\$101	N/A	\$251
	19-1/4"	18"	1-1/4"	Bolt-Thru	PHIX303.18.1925 BT	\$183	N/A	\$333
				Back-to-Back	PHIX303.18.1925 BTB	\$255	N/A	\$555
				Self-Tapping	PHIX303.18.1925 ST	\$183	N/A	\$333
 90°	13"	12"	1"	Bolt-Thru	PHIX45012 BT	\$215	\$246	\$365
				Back-to-Back	PHIX45012 BTB	\$372	\$387	\$672
				Self-Tapping	PHIX45012 ST	\$215	\$246	\$365

Bolt-Thru consists of 1 single pull + 1 Bolt-Thru fixing pack (function code: BT)

Back-to-Back consists of 2 single pulls + 1 Back-to-Back fixing pack (function code: BTB)

PARTS AND SERVICES

Fixing Packs (Self Taping) for Surface Pulls					Finish	
					32,32D, 19G	CeraMax
Surface Pull	Tube Dia.	Fixing	Door Thickness	Item Code	Price	
PHIX301	3/4"	Self Taping	1-3/4"	PHIX9106	\$48	\$68
PHIX311	3/4"					
PHIX41714	7/8"					
PHIX45714	1"					
PHIX330	7/8"					
PHIX332	1"					
PHIX312	1"		3"			
PHIX313	1-1/4"					
PHIX322	1"					
PHIX323	1-1/4"					
PHIX333	1-1/4"					
PHIX45012	1" x 1/2"					
PHIX343	1-1/4"					

PARTS AND SERVICES

					Finish	
					32,32D, 19G	CeraMax
Fixing Packs (Bolt-Thru) for Surface Pulls						
Surface Pull	Tube Dia.	Fixing	Door Thickness	Item Code	Price	
PHIX301 PHIX311 PHIX41714 PHIX45714	3/4" 3/4" 7/8" 1"	Bolt Thru	1-3/4"	PHIX9109	\$366	\$76
			2"			
			2-1/4"	PHIX9109 + PHIX9580	\$42	\$103
			2-1/2"			
			2-3/4"	PHIX9109 + PHIX9590	\$42	\$103
			3"			
PHIX330 PHIX332	7/8" 1"	Bolt Thru	1-3/4"	PHIX9121	\$42	\$103
			2"	PHIX9121 + PHIX9680	\$48	\$108
			2-1/4"			
			2-1/2"	PHIX9121 + PHIX9690	\$48	\$108
			2-3/4"			
3"						
PHIX312 PHIX313 PHIX322 PHIX323 PHIX333 PHIX45012 PHIX343	1" 1-1/4" 1" 1-1/4" 1-1/4" 1" x 1/2" 1-1/4"	Bolt Thru	1-3/4"	PHIX9104	\$48	\$108
			2"			
			2-1/4"			
			2-1/2"	PHIX9104 - PHIX9138	\$54	\$113
			2-3/4"			
			3"			

PARTS AND SERVICES

Surface Pull Fixing Packs - Back-to-Back					Finish
					32, 32D, 19G
Surface Pull	Tube Dia.	Fixing	Door Thickness	Item Code	Price
PHIX301 PHIX311 PHIX41714 PHIX45714	3/4" 3/4" 7/8" 1 x 1/2"	Back-to-Back	1-3/4"	PHIX9112	\$28
			2"	PHIX9112 + PHIX8580	\$34
			2-1/4"		
			2-1/2"	PHIX9112 + PHIX8590	\$34
			2-3/4"	PHIX9112 + PHIX8510	\$34
			3"		
PHIX330 PHIX332	7/8" 1"	Back-to-Back	1-3/4"	PHIX9122	\$28
			2"	PHIX9122 + PHIX8680	\$34
			2-1/4"		
			2-1/2"	PHIX9122 + PHIX8690	\$34
			2-3/4"	PHIX9122 + PHIX9610	\$34
			3"		
PHIX312 PHIX313 PHIX322 PHIX323 PHIX333 PHIX45012	1" 1-1/4" 1" 1-1/4" 1-1/4" 1 x 1/2"	Back-to-Back	1-3/4"	PHIX9105	\$28
			2"	PHIX9105 + PHIX9138	\$34
			2-1/4"		
			2-1/2"	PHIX9105 + PHIX8120	\$34
			2-3/4"		
			3"		
PHIX343	1-1/4"	Back-to-Back	1-3/4"	PHIX9105	\$28
			2"	PHIX9105 + PHIX9132	\$34
			2-1/4"	PHIX9105 + PHIX9137	
			2-1/2"	PHIX9105 + PHIX9131	
			2-3/4"	PHIX9105 + PHIX9138	
			3"	PHIX9105 + PHIX8105	

Concealed Bearing Hinges
HEAVY WEIGHT, 3 KNUCKLE BEARING

						Finish	
Stainless Steel						32D	32
Size	Corner	Thickness (Ga.)	Type	QTY	Item No.	Price (EA)	
4-1/2" x 4-1/2"	Square Corner	0.180" (4.6mm)	Concealed Bearing	EA	HG5111CB-47	\$98	S/O
5" x 4-1/2"	Square Corner	0.190" (4.8mm)	Concealed Bearing NRP	EA	HG5111CB-NRP-56	\$106	S/O

						Finish		
Steel						26D	10B	19G
Size	Corner	Thickness (Ga.)	Type	QTY	Item No.	Price (EA)		
4-1/2" x 4-1/2"	Square Corner	0.180" (4.6mm)	Concealed Bearing	EA	HG8111CB-47	S/O	\$40	S/O
			Concealed Bearing NRP	EA	HG8111CB-NRP-47	\$56	S/O	S/O
5" x 4-1/2"	Square Corner	0.190" (4.8mm)	Concealed Bearing	EA	HG8111CB-56	\$59	\$59	S/O
			Concealed Bearing NRP	EA	HG8111CB-NRP-56	\$62	\$62	S/O

						Finish		
STANDARD WEIGHT, 3 KNUCKLE BEARING						26D	10B	19G
Steel								
Size	Corner	Thickness (Ga.)	Type	QTY	Item No.	Price (EA)		
4-1/2" x 4-1/2"	Square Corner	0.134" (3.4mm)	Concealed Bearing	EA	HG8112CB-45	\$33	\$35	\$40
			Concealed Bearing NRP	EA	HG8112CB-NRP-45	\$38	S/O	S/O
		0.180" (4.6mm)	Concealed Bearing NRP	EA	HG8112CB-NRP-47	S/O	\$40	S/O
5" x 4-1/2"	Square Corner	0.146" (3.7mm)	Concealed Bearing	EA	HG8112CB-54	\$40	S/O	S/O
			Concealed Bearing NRP	EA	HG8112CB-NRP-54	\$46	S/O	S/O

NRP: Non-removable Pin
 CB: Concealed Bearings
 S/O: Special order item, contact the sales department for pricing and lead times.

Template Hinges

Standard weight, 2 Anti-friction ball bearing & plain bearing

						Finish	
Stainless Steel						32D	32
Size	Corner	Thickness (Ga.)	Type	QTY	Item No.	Price (EA)	
4" x 4"	Square Corner	0.13" (3.3mm)	2 Ball Bearing	EA	HG5112-43	\$61	\$71
			2 Ball Bearing NRP	EA	HG5112NRP-43	\$65	S/O
	1/4" Radius Corner	0.13" (3.3mm)	2 Ball Bearing NRP	EA	HG5112R14NRP-43	\$62	\$66
	5/8" Radius Corner	0.13" (3.3mm)	2 Ball Bearing NRP	EA	HG5112R58NRP-43	\$62	\$66
4-1/2" x 4"	Square Corner	0.134" (3.4mm)	2 Ball Bearing	EA	HG5112-44	\$64	S/O
4-1/2" x 4-1/2"	Square Corner	0.134" (3.4mm)	2 Ball Bearing	EA	HG5112-45	\$66	S/O
			2 Ball Bearing NRP	EA	HG5112NRP-45	\$70	S/O

						Finish		
Steel						15 ⁶ , 4 ⁶ , 26D	19G 10B	26
Size	Corner	Thickness (Ga.)	Type	QTY	Item No.	Price (EA)		
4" x 4"	Square Corner	0.134" (3.4mm)	2 Ball Bearing	EA	HG8112-43	\$25	\$29	S/O
	Radius Corner		2 Ball Bearing	EA	HG8112R14-43	\$25	S/O	S/O
4-1/2" x 4"	Square Corner	0.134" (3.4mm)	2 Ball Bearing	EA	HG8112-44	\$25	S/O	S/O
			2 Ball Bearing NRP	EA	HG8112NRP-44	\$27	S/O	S/O
4-1/2" x 4-1/2"	Square Corner	0.134" (3.4mm)	2 Ball Bearing	EA	HG8112-45	\$26	\$29	\$33
			2 Ball Bearing NRP	EA	HG8112NRP-45	\$29	\$33	S/O
5" x 4-1/2"	Square Corner	0.146" (3.7mm)	2 Ball Bearing	EA	HG8112-54	\$33	S/O	S/O
			2 Ball Bearing NRP	EA	HG8112NRP-54	\$36	S/O	S/O

⁶Finish Options

15 finish available for HG8112-45

4 finish available for HG8112-45

NRP: Non-removable Pin

S/O: Special order item, contact the sales department for pricing and lead times.

Spring Hinges
COMMERCIAL WEIGHT

						Finish	
Stainless Steel						32D	32
Size	Corner	Thickness (Ga.)	Type	QTY	Item No.	Price (EA)	
4" x 4"	Square Corner	0.13" (3.3mm)	Spring Hinges	EA	HG5107SP-43	\$86	S/O
	Radius Corner		Spring Hinges	EA	HG5107SPR14-43	\$86	S/O
4-1/2" x 4-1/2"	Square Corner	0.134" (3.4mm)	Spring Hinges	EA	HG5107SP-45	\$92	S/O

						Finish	
Steel						26D	19G, 10B
Size	Corner	Thickness (Ga.)	Type	QTY	Item No.	Price (EA)	
4" x 4"	Radius Corner	0.13" (3.3mm)	Spring Hinges	EA	HG8107SPR14-43	\$40	S/O
4-1/2 x 4-1/2"	Square Corner	0.134" (3.4mm)	Spring Hinges	EA	HG8107SP-45	\$42	\$46

Heavy Duty Template Hinges

HEAVY WEIGHT, 4 ANTI-FRICTION BALL BEARING

						Finish	
Stainless Steel						32D	32
Size	Corner	Thickness (Ga.)	Type	QTY	Item No.	Price (EA)	
4-1/2" x 4-1/2"	Square Corner	0.180" (4.6mm)	4 Ball Bearing	EA	HG5111-47	\$92	S/O
			4 Ball Bearing NRP	EA	HG5111NRP-47	\$96	S/O
5" x 4-1/2"	Square Corner	0.190" (4.8mm)	4 Ball Bearing	EA	HG5111-56	\$98	S/O
5" X 5"	Square Corner	0.190" (4.8mm)	4 Ball Bearing	EA	HG5111-57	\$103	S/O

						Finish	
Steel						26D	10B, 19G
Size	Corner	Thickness (Ga.)	Type	QTY	Item No.	Price (EA)	
4-1/2" x 4-1/2"	Square Corner	0.180" (4.6mm)	4 Ball Bearing	EA	HG8111-47	\$46	S/O
			4 Ball Bearing NRP	EA	HG8111NRP-47	\$51	S/O
5" x 4-1/2"	Square Corner	0.190" (4.8mm)	4 Ball Bearing	EA	HG8111-56	\$53	S/O
			4 Ball Bearing NRP	EA	HG8111NRP-56	\$57	S/O
5" x 5"	Square Corner	0.190" (4.8mm)	4 Ball Bearing	EA	HG8111-57	\$55	S/O
			4 Ball Bearing NRP	EA	HG8111NRP-57	\$59	S/O

Power Transfer Hinges

						Finish	
Steel						26D	19G
Size	Corner	Thickness (Ga.)	Type	QTY	Item No.	Price (EA)	
4-1/2" x 4-1/2"	Square Corner	0.134" (3.4mm)	2 Ball Bearing	EA	HG8112-45-ETH4W	\$408	\$438

NRP: Non-removable Pin

S/O: Special order item, contact the sales department for pricing and lead times.

Residential Hinges
PLAIN BEARING HINGES

						Finish	
Stainless Steel						32D	32
Size	Corner	Thickness (Ga.)	Type	QTY	Item No.	Price (EA)	
4" x 4"	Square Corner	0.13" (3.3mm)	Plain Bearing	EA	HG5133-43	\$50	S/O

						Finish	
Steel						26D	19G
Size	Corner	Thickness (Ga.)	Type	QTY	Item No.	Price (EA)	
4-1/2" x 4-1/2"	Square Corner	0.134" (3.4mm)	Plain Bearing	EA	HG8133-45	\$22	S/O

S/O: Special order item, contact the sales department for pricing and lead times.

Residential Hinges
COMMERCIAL WEIGHT

						Finish	
Stainless Steel						32D	32
Size	Corner	Thickness (Ga.)	Type	QTY	Item No.	Price (EA)	
4" x 4"	Square Corner	0.097" (2.5mm)	Hinges	EA	HG5184-42	\$40	\$45
	Radius 1/4" Corner			EA	HG5184R14-42	\$40	\$45
	Radius 5/8" Corner			EA	HG5184R58-42	\$40	\$45

NRP: Non-removable Pin

S/O: Special order item, contact the sales department for pricing and lead times.









Stainless Steel Door Stops

For Interior Doors

Image	Description	Item No.	Finish				
			32D	32	10B, 19G	PVD4	CGY, CDB C19G, C19
			Price				
	Floor mounted Screws included	DSIX02	\$30	\$32	\$32	\$32	\$90
	Wall mounted, also can be used as coat hook, screws included	DSIX04	\$27	\$33	\$33	\$33	\$87
	Black rubber tip only	DSIX04RUB	\$7	N/A	N/A	N/A	N/A
	Floor or wall mounted Screws included	DSIX05	\$22	\$24	N/A	N/A	\$82
	Floor mounted Screws included	DSIX06	\$25	\$27	N/A	N/A	\$85
	Wall mounted Screws included	DSIX07	\$25	\$27	N/A	N/A	\$85
	Wall mounted Screws included	DSIX08	\$23	\$25	N/A	\$25	\$83
	Wall mounted, screws included	DSIX09	\$22	\$24	\$24	\$24	\$82
	Door Stop Extension	DSIX09EX	\$17	\$19	\$19	N/A	\$77
	Black rubber tip only	DSIX09RUB	\$7	N/A	N/A	N/A	N/A
	White rubber tip only	DSIX09RUB-WH	\$10	N/A	N/A	N/A	N/A
	Wall mounted, also can be used as coat hook, screws included	DSIX14	\$23	\$25	\$25	\$25	\$83
	Black rubber tip only	DSIX14RUB	\$7	N/A	N/A	N/A	N/A
	Wall mounted, also can be used as coat hook, screws included	DSIX19	\$25	\$27	\$27	\$27	\$85
	Black rubber tip only	DSIX14RUB	\$7	N/A	N/A	N/A	N/A
	Floor mounted Screw included	DSIX26	\$46	\$50	\$50	\$50	\$106
	Floor mounted Screw included	DSIX34	\$43	\$46	\$46	\$46	\$103

Stainless Steel Pocket Pulls

For Interior Doors

Image	Description	Item No.	Finish			
			32, 32D	19G	PVD4	CGY, CDB C19G, C19
			Price			
	Pocket pull circular faceplate dia. 2-9/16", concealed fixing, screws included	FHIX01	\$22	\$24	\$24	\$112
	Pocket pull semi-circular faceplate dia. 3-9/16", concealed fixing, screws included	FHIX02	\$30	N/A	\$25	\$120
	Pocket pull rectangular faceplate 2-3/8"x7-1/16", concealed fixing, screws included	FHIX03	\$33	\$37	\$37	\$123
	Pocket pull oblong faceplate 1-5/8"x4-3/4", concealed fixing, screws included	FHIX04	\$22	\$24	\$24	\$112
	Pocket pull square faceplate 2-3/4", concealed fixing, screws included	FHIX05	\$30	\$35	\$35	\$120
	Pocket pull rectangular faceplate 1-7/8" x 4-3/4", concealed fixing, screws included	FHIX06	\$22	\$24	\$24	\$112
	Pocket pull rectangular faceplate 2-3/8"x7-1/16", with rectangular opening, concealed fixing, screws included	FHIX07	\$33	\$37	\$37	\$123
	Round edge pull, 1" (25.4mm) dia., concealed fixing, screws included	EPIX01	\$14	\$17	\$17	\$104

Stainless Steel Numbers and Letters

Concealed Fixing:

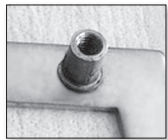

Finish			
32D	32	10B	CGY, CDB C19G, C19

Accessory Type	Size	Number	Item Code	Price			
Concealed Fixing							
Number	3"	0	NUIXN30	\$20	\$22	\$26	\$90
Number	3"	1	NUIXN31	\$20	\$22	\$26	\$90
Number	3"	2	NUIXN32	\$20	\$22	\$26	\$90
Number	3"	3	NUIXN33	\$20	\$22	\$26	\$90
Number	3"	4	NUIXN34	\$20	\$22	\$26	\$90
Number	3"	5	NUIXN35	\$20	\$22	\$26	\$90
Number	3"	6	NUIXN36	\$20	\$22	\$26	\$90
Number	3"	7	NUIXN37	\$20	\$22	\$26	\$90
Number	3"	8	NUIXN38	\$20	\$22	\$26	\$90
Number	3"	9	NUIXN39	\$20	\$22	\$26	\$90
Number	4"	0	NUIXN40	\$25	\$27	\$30	\$95
Number	4"	1	NUIXN41	\$25	\$27	\$30	\$95
Number	4"	2	NUIXN42	\$25	\$27	\$30	\$95
Number	4"	3	NUIXN43	\$25	\$27	\$30	\$95
Number	4"	4	NUIXN44	\$25	\$27	\$30	\$95
Number	4"	5	NUIXN45	\$25	\$27	\$30	\$95
Number	4"	6	NUIXN46	\$25	\$27	\$30	\$95
Number	4"	7	NUIXN47	\$25	\$27	\$30	\$95
Number	4"	8	NUIXN48	\$25	\$27	\$30	\$95
Number	4"	9	NUIXN49	\$25	\$27	\$30	\$95
Letter	3"	A	LTIXN3A	\$20	\$22	\$26	\$90
Letter	3"	B	LTIXN3B	\$20	\$22	\$26	\$90
Letter	3"	C	LTIXN3C	\$20	\$22	\$26	\$90
Letter	3"	D	LTIXN3D	\$20	\$22	\$26	\$90
Letter	4"	A	LTIXN4A	\$23	\$26	\$29	\$93
Letter	4"	B	LTIXN4B	\$23	\$26	\$29	\$93
Letter	4"	C	LTIXN4C	\$23	\$26	\$29	\$93
Letter	4"	D	LTIXN4D	\$23	\$26	\$29	\$93

Numbers 0 to 9 available in 3" and 4" (Concealed Fixing or Face Fixing)

Letters A, B, C and D available in 3" and 4" (Concealed Fixing or Face Fixing) size

Letters A through Z available in 3" (Concealed Fixing) size

Concealed Fixing: Welded bolt sleeves on the back; special anchors and plugs supplied

Additional letters are available, contact a sales representative for details

CeraMax™ Price Groups

Group A				Group B										Group C	
Graphite Black C19G	Stormy Grey CGY	Flat Black C19	Dark Bronze CDB	Aqua Blue C26	Goblin Green C23	Red Hot C28	Bordeaux C20	Pink Bubblegum C22	Purple Reign C25	Deep Blue Sea C27	Ocean Blue C24	Cobalt Cool C31	Sand Man C29	Moon Light C30	Sun Dazed C21

Custom Items

Please note that custom requests require special pricing and may not be covered under our warranty. Contact sales@unisonhardware.com for more information.

CeraMax™ Finishes

CeraMax™ ceramic coating finishes are guaranteed against finish defects and cracking, chipping, peeling, and flaking under normal use for up to two (2) years for commercial interior use. Ceramic coating will wear over time under normal use, and this warranty does not cover normal wear and tear of the product (which varies per color of finish) or any damage, alteration, or abuse to the finish from neglect or accident. Exterior installation or exposure to UV light will affect ceramic coating as part of normal wear and tear. INOX CeraMax ceramic coating is not UV rated. Contact INOX for information on higher UV CeraMax protection if needed.

Not covered under this Warranty:

- Product that has been scratched or abraded
- Product that has been incorrectly installed or mistreated
- Product installed in exterior applications and/or exposed to the water, outdoor weather, or elements, harsh environments, and/or commercial or industrial applications.
- Living Finishes, which are specifically designed to wear over time (i.e., Oil Rubbed Bronze finish)

UNISON HARDWARE, INC. MAKES NO OTHER WARRANTY, AND ALL IMPLIED WARRANTIES INCLUDING ANY WARRANTY OF MERCHANTABILITY OR FITNESS FOR A PARTICULAR PURPOSE ARE LIMITED TO THE DURATION OF THE EXPRESSED WARRANTY PERIOD AS SET FORTH ABOVE. THE COMPANY'S MAXIMUM LIABILITY HEREUNDER IS LIMITED TO THE PURCHASE PRICE OF THE PRODUCT. IN NO EVENT SHALL THE COMPANY BE LIABLE FOR ANY CONSEQUENTIAL, INDIRECT, INCIDENTAL OR SPECIAL DAMAGES OF ANY NATURE ARISING FROM THE SALE OR USE OF THIS PRODUCT, WHETHER IN CONTRACT, TORT, STRICT LIABILITY OR OTHERWISE. THIS LIMITED WARRANTY IS IN LIEU OF ALL OTHER WARRANTIES, EXPRESSED OR IMPLIED, INCLUDING THE IMPLIED WARRANTIES OF FITNESS AND MERCHANTABILITY. THERE ARE NO WARRANTIES WHICH EXTEND BEYOND THE DESCRIPTION ON THE FACE HEREOF.

CeraMax™ Price Groups

To order INOX Ceramic Coating:

1. Take list of desired product using 32D finish
2. Select the group [A or B or C] finish and add upcharge list pricing in chart
3. Additional one time setup fee per color based on quantities for Rainbeaux™ Group B & C

Setup Fee for Rainbeaux™ per color:

\$450 NET for quantities less than and equal to 25 pieces / sets
 \$300 NET for quantities greater than 25 pieces / sets

Lead Times:

4 - 5 weeks for Group A
 6 - 8 weeks for Group B & C

Category	Series or Size	Group A	Group B	Group C
		Add to List Price		
Interiors	RA / SE / GT / GS / SH Tubular Latch Sets	\$180	\$210	\$280
	RA / SE / GT / GS / SH Tubular Half Passage	\$150	\$170	\$300
	RA / SE / GT / GS / SH Tubular Single Dummy	\$120	\$140	\$240
Lock Sets	XRA / XSE / XGT / XGS Series	\$190	\$220	\$380
	SF / LA Tubular & Mortise	\$280	\$330	\$560
	SF / LA Tubular & Mortise Dummy Pair	\$200	\$230	\$400
Cylindrical Locks	BL / BM / BK / CL / CK - 07 or 09 lever Set	\$240	\$280	\$480
	BL / BM / BK / CL / CK - 07 or 09 Single Dummy	\$190	\$220	\$380
Entrance Handleset	NY / MH / ME / BW - Tubular Active / Dummy Sets	\$480	\$540	\$960
	NY / MH / ME / BW - Mortise Active / Dummy Sets	\$430	\$490	\$860
Universal Multipoint	BP / MU - All lever designs & functions	\$230	\$310	\$460
Deadbolts / Privacy Bolts	All series	\$180	\$190	\$360
PD2000	Complete sets with Flush Pulls FH12 / FH13 / FH22CF / FH23CF	\$190	\$210	\$380
Pocket Door Locks PD8000 / PD5000	Complete sets with Flush Pulls FH17 / FH22 / FH23 / FH27 / FH29 / FH31 / FH32	\$250	\$300	\$500
	Complete set the ADA Pull PHIX31108 / PHIX30108 / PHIX330.512.8	\$280	\$330	\$560
	Faceplate only	\$60	\$70	\$120
	Strike only	\$40	\$50	\$80
	Thumbturn only	\$70	\$81	\$140
	Flush Pulls Only FH17 / FH22 / FH23 / FH27 / FH29 / FH31 / FH32	\$120	\$130	\$240
Sliding Door Locks PD9000 Series	Complete Sets	\$280	\$460	\$560
Surface Pulls <i>Pricing is per single pull (BT) For BTB pricing will be multiplied by 2</i>	8" ADA Pulls	\$130	\$160	\$260
	Over 8" to 18" CTC Pull	\$150	\$180	\$300
	Over 18" to 33" CTC Pull	\$280	\$310	\$560
	Over 33" to 48" CTC Pull	\$430	\$490	\$860
	Over 48" to 60" CTC Pull	\$580	\$660	\$1,160
	Greater than 60" CTC Pull	\$690	\$780	\$1,380
Barn Door Locks	BD1000 & BD4000	\$130	\$160	\$260
Accessories	Rim and Mortise Cylinder, IC Core Housing	\$120	\$130	\$220
	Euro Cylinder	\$160	\$190	\$320
	Hinges - Plain Bearing	\$400	\$460	\$800
	Thick Door Kits (Privacy / Handlesets)	\$120	\$130	\$240
	Doorstops - DSIX	\$60	\$70	\$120
	Flush Pulls / Edge Pulls - FHIX / EPIX	\$90	\$130	\$180
	Letters - LTIX / Numbers - NUIX	\$70	\$80	\$140
Exit Device Trim	XSF Entry / Night Latch	\$190	\$240	\$380
	XSF Passage / Dummy	\$170	\$220	\$340

MicroArmor™ Price

To order INOX MicroArmor Antimicrobial Coating:

1. Take list of desired product with requested finish
2. Add upcharge list pricing in chart
3. Calculate your company's discount price

Setup Fee:

Clear Cost \$80 NET

Black Coat: \$450 NET

Lead Times:

2 - 4 weeks for Group A

2 - 6 weeks for Group B

Category	Series or Size	Clear Coat	Black Coat
		Add to List Price	
Interiors	RA / SE / GT / GS / SH Tubular Latch Sets	\$180	\$280
	RA / SE / GT / GS / SH Tubular Half Passage	\$150	\$300
	RA / SE / GT / GS / SH Tubular Single Dummy	\$120	\$240
Lock Sets	XRA / XSE / XGT / XGS Series	\$190	\$380
	SF / LA Tubular & Mortise	\$280	\$560
	SF / LA Tubular & Mortise Dummy Pair	\$200	\$400
Cylindrical Locks	BL / BM / BK / CL / CK - 07 or 09 lever Set	\$240	\$480
	BL / BM / BK / CL / CK - 07 or 09 Single Dummy	\$190	\$380
Entrance Handleset	NY / MH / ME / BW - Tubular Active / Dummy Sets	\$480	\$960
	NY / MH / ME / BW - Mortise Active / Dummy Sets	\$430	\$860
Universal Multipoint	BP / MU - All lever designs & functions	\$230	\$460
Deadbolts / Privacy Bolts	All series	\$180	\$360
PD2000	Complete sets with Flush Pulls FH12 / FH13 / FH22CF / FH23CF	\$190	\$380
Pocket Door Locks PD8000 / PD5000	Complete sets with Flush Pulls FH17 / FH22 / FH23 / FH27 / FH29 / FH31 / FH32	\$250	\$500
	Complete set the ADA Pull PHIX31108 / PHIX30108 / PHIX330.512.8	\$280	\$560
	Faceplate only	\$60	\$120
	Strike only	\$40	\$80
	Thumbturn only	\$70	\$140
	Flush Pulls Only FH17 / FH22 / FH23 / FH27 / FH29 / FH31 / FH32	\$120	\$240
Sliding Door Locks PD9000 Series	Complete Sets	\$280	\$560
Surface Pulls <i>Pricing is per single pull (BT)</i> <i>For BTB pricing will be multiplied by 2</i>	8" ADA Pulls	\$130	\$260
	Over 8" to 18" CTC Pull	\$150	\$300
	Over 18" to 33" CTC Pull	\$280	\$560
	Over 33" to 48" CTC Pull	\$430	\$860
	Over 48" to 60" CTC Pull	\$580	\$1,160
	Greater than 60" CTC Pull	\$690	\$1,380
Barn Door Locks	BD1000 & BD4000	\$130	\$260
Accessories	Rim and Mortise Cylinder, IC Core Housing	\$120	\$220
	Euro Cylinder	\$160	\$320
	Hinges - Plain Bearing	\$400	\$800
	Thick Door Kits (Privacy / Handlesets)	\$120	\$240
	Doorstops - DSIX	\$60	\$120
	Flush Pulls / Edge Pulls - FHIX / EPIX	\$90	\$180
	Letters - LTIX / Numbers - NUIX	\$70	\$140
Exit Device Trim	XSF Entry / Night Latch	\$190	\$380
	XSF Passage / Dummy	\$170	\$340

Understanding Handing

Swing Door versus Sliding Door

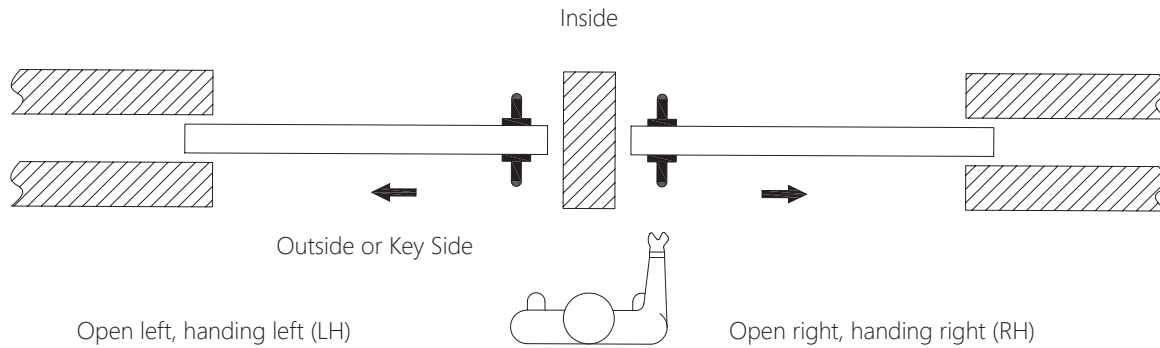

SLIDING DOOR HANDING

- Handing refers to the direction the door slides open. Example: If the door slides to the left to open, it is a left-handed door.
- Determine door direction from the exterior or key side of the door when facing into the room.

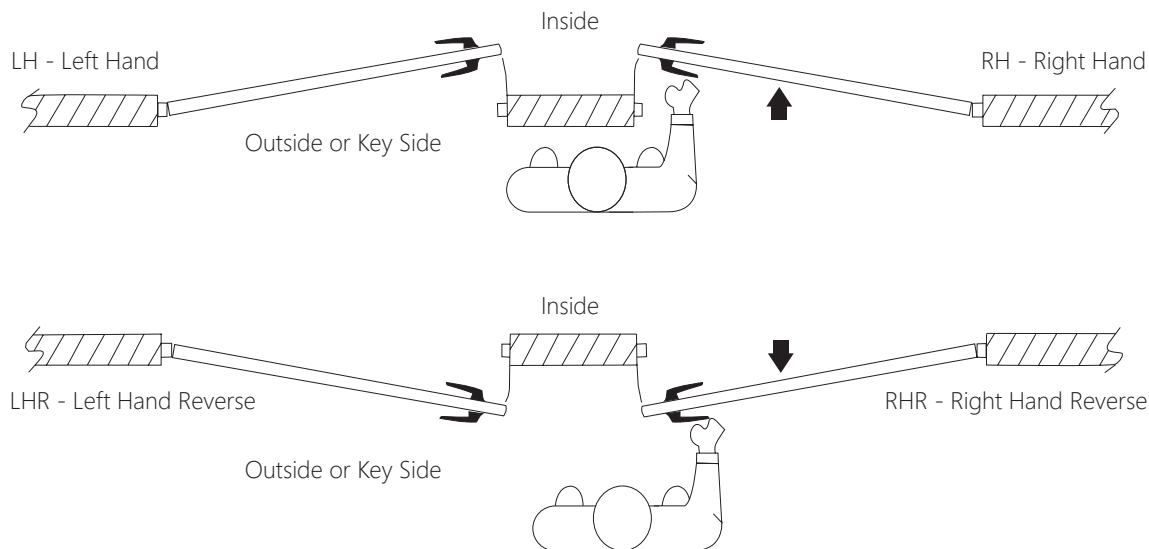

SWING DOOR HANDING

- Handing refers to the direction the door swings open. Example: If the door swings open to the left, it is a left-handed door.
- Determine door direction from the exterior or key side of the door when facing into the room.

INOX COMMERCIAL PRODUCT WARRANTY

Limited Commercial Warranty

Unison Hardware, Inc. ("INOX") warrants its commercial products shall be free from defects in material and workmanship under normal use and regular service and maintenance for a period of three (3) years from the date of delivery, excluding components made of wood, leather, or plastic.

If a product fails due to defects in material or workmanship during the warranty period, INOX will replace it with the most nearly identical product which we sell at the time. INOX will not be liable for any labor charges or freight costs incurred in connection with repair or replacement of a product. The sole and maximum liability for defective goods sold and manufactured by INOX shall never exceed the cost of the subject products.

This warranty does not cover:

1. Damage resulting from negligence, misuse, abuse, or accident occurring during or after installation
2. Damage due to use outside normal architectural requirements
3. Defects resulting from any modification or improper installation
4. Improper torquing (tightening) during or after installation
5. Improper door preparation
6. Use of residential grade products in commercial applications
7. Products installed in exterior application and/or exposed to the water, outdoor weather, or elements

Custom Items

Custom Items require special pricing and may not be covered under our warranty. Contact sales@unisonhardware.com for more information.

Limited Finish Warranty

Unison Hardware warrants its INOX products made of stainless steel material and with stainless steel finish (polished or satin) against tarnishing for up to three (3) years for commercial use so long as proper, regular care and maintenance occur.

This warranty does not cover:

- Damage resulting from using installation compounds that are harmful to metal finishes or using harsh cleaning solutions or any cleaning detergent containing chlorides, alcohol, or lime deposits
- Product installed in exterior applications and/or exposed to the water, outdoor weather or elements, or harsh environments
- Changes to living finishes that normally take place with the passage of time, including 10B Oil Rubbed Bronze and 19G Graphite Black
- Use in any manner contrary to INOX's printed instructions

CeraMax™ Finishes

CeraMax ceramic coating finishes are guaranteed against finish defects and cracking, chipping, peeling, and flaking under normal use for up to two (2) years. Ceramic coating will wear over time under normal use, and this warranty does not cover normal wear and tear of the product (which varies per color of finish) or any damage, alteration, or abuse to the finish from neglect or accident. Exterior installation, exposure to UV light or salt spray will affect ceramic coating as part of normal wear and tear. INOX CeraMax ceramic coating is not UV rated.

UNISON HARDWARE, INC. MAKES NO OTHER WARRANTY, AND ALL IMPLIED WARRANTIES INCLUDING ANY WARRANTY OF MERCHANTABILITY OR FITNESS FOR A PARTICULAR PURPOSE ARE LIMITED TO THE DURATION OF THE EXPRESSED WARRANTY PERIOD AS SET FORTH ABOVE. THE COMPANY'S MAXIMUM LIABILITY HEREUNDER IS LIMITED TO THE PURCHASE PRICE OF THE PRODUCT. IN NO EVENT SHALL THE COMPANY BE LIABLE FOR ANY CONSEQUENTIAL, INDIRECT, INCIDENTAL OR SPECIAL DAMAGES OF ANY NATURE ARISING FROM THE SALE OR USE OF THIS PRODUCT, WHETHER IN CONTRACT, TORT, STRICT LIABILITY OR OTHERWISE. THIS LIMITED WARRANTY IS IN LIEU OF ALL OTHER WARRANTIES, EXPRESSED OR IMPLIED, INCLUDING THE IMPLIED WARRANTIES OF FITNESS AND MERCHANTABILITY. THERE ARE NO WARRANTIES WHICH EXTEND BEYOND THE DESCRIPTION ON THE FACE HEREOF.

INOX RESIDENTIAL PRODUCT WARRANTY

Limited Mechanical Warranty

Unison Hardware, Inc. ("INOX") warrants its residential products shall be free from defects in material and workmanship under normal use and regular service and maintenance for the life of the product for Residential use, excluding components made of wood, leather, or plastic. This Warranty extends to the original purchaser and first consumer owner only.

If a product fails due to defects in material or workmanship during the warranty period, INOX will replace it with the most nearly identical product which we sell at the time. INOX will not be liable for any labor charges or freight costs incurred in connection with repair or replacement of a product. Our sole and maximum liability for defective goods (sold and manufactured by INOX) shall never exceed the cost of the subject products.

This warranty does not cover:

1. Damage resulting from negligence, misuse, abuse, or accident occurring during or after installation
2. Damage due to use outside normal architectural requirements
3. Defects resulting from any modification or improper installation
4. Improper torquing (tightening) during or after installation
5. Improper door preparation
6. Use of residential grade products in commercial applications
7. Products installed in exterior application and/or exposed to the water, outdoor weather, or elements

Custom Items

Custom Items require special pricing and may not be covered under our warranty. Contact sales@unisonhardware.com for more information.

Finishes

With regular care and maintenance to remove stains, dirt, and condensation, Finishes are also covered for a period of three (3) years.

This warranty does not cover:

1. Damage resulting from using installation compounds that are harmful to brass and metal finishes or using improper cleaning solutions such as disinfection/antibacterial solutions or any cleaning detergent containing chlorides, alcohol or lime deposits
2. Product installed in exterior applications and/or exposed to the water, outdoor weather, or elements, harsh environments, and/or commercial or industrial applications
3. Changes to finish that normally take place with the passage of time
4. Use in any manner contrary to INOX's printed instructions.

CeraMax™ Finishes

CeraMax ceramic coating finishes are guaranteed against finish defects and cracking, chipping, peeling, and flaking under normal use for up to two years for commercial use. Ceramic coating will wear over time under normal use, and this warranty does not cover normal wear and tear of the product (which varies per color of finish) or any damage, alteration, or abuse to the finish from neglect or accident. Exterior installation, exposure to UV light or salt spray will affect ceramic coating as part of normal wear and tear. INOX CeraMax ceramic coating is not UV rated. No representative or employee of INOX/Unison Hardware, Inc. is authorized to make any modification or addition to this warranty.

UNISON HARDWARE, INC. MAKES NO OTHER WARRANTY, AND ALL IMPLIED WARRANTIES INCLUDING ANY WARRANTY OF MERCHANTABILITY OR FITNESS FOR A PARTICULAR PURPOSE ARE LIMITED TO THE DURATION OF THE EXPRESSED WARRANTY PERIOD AS SET FORTH ABOVE. THE COMPANY'S MAXIMUM LIABILITY HEREUNDER IS LIMITED TO THE PURCHASE PRICE OF THE PRODUCT. IN NO EVENT SHALL THE COMPANY BE LIABLE FOR ANY CONSEQUENTIAL, INDIRECT, INCIDENTAL OR SPECIAL DAMAGES OF ANY NATURE ARISING FROM THE SALE OR USE OF THIS PRODUCT, WHETHER IN CONTRACT, TORT, STRICT LIABILITY OR OTHERWISE. THIS LIMITED WARRANTY IS IN LIEU OF ALL OTHER WARRANTIES, EXPRESSED OR IMPLIED, INCLUDING THE IMPLIED WARRANTIES OF FITNESS AND MERCHANTABILITY. THERE ARE NO WARRANTIES WHICH EXTEND BEYOND THE DESCRIPTION ON THE FACE HEREOF.

INOX ELECTRONIC PRODUCTS WARRANTY

Limited Electronic Warranty

Unison Hardware, Inc. ("INOX") warrants its electronic products shall be free from defects in material and workmanship under normal use and regular service and maintenance for one (1) year, excluding components made of wood, leather, or plastic.

If a product fails due to defects in material or workmanship during the warranty period, INOX will replace it with the most nearly identical product which we sell at the time. INOX will not be liable for any labor charges or freight costs incurred in connection with repair or replacement of a product. Our sole and maximum liability for defective goods sold and manufactured by INOX shall never exceed the cost of the subject products.

This warranty does not cover:

1. Damage resulting from negligence, misuse, abuse, or accident occurring during or after installation
2. Damage due to use outside normal architectural requirements
3. Defects resulting from any modification or improper installation
4. Improper torquing (tightening) during or after installation
5. Improper door preparation
6. Use of residential grade products in commercial applications
7. Products installed in exterior application and/or exposed to the water, outdoor weather, or elements

Custom Items

Custom Items require special pricing and may not be covered under our warranty. Contact sales@unisonhardware.com for more information.

Limited Finishes Warranty

Unison Hardware warrants its INOX Products made of stainless steel material and with stainless steel finish (polished or satin) against tarnishing for the life of the product for residential use and for up to three (3) years for commercial use so long as proper, regular care and maintenance occur. This warranty is extended to the original purchaser of INOX products if the user occupies the residential premises on which the products were originally installed.

This warranty does not cover:

- Damage resulting from using installation compounds that are harmful to metal finishes or using harsh cleaning solutions or any cleaning detergent containing chlorides, alcohol or lime deposits
- b. Product installed in exterior applications and/or exposed to the water, outdoor weather, or elements, harsh environments, and/or commercial or industrial applications
- c. Changes to living finishes that normally take place with the passage of time, including 10B Oil Rubbed Bronze and 19G Graphite Black
- d. Use in any manner contrary to INOX's printed instructions

CeraMax™ Finishes

CeraMax ceramic coating finishes are guaranteed against finish defects and cracking, chipping, peeling, and flaking under normal use for up to two years for commercial use. Ceramic coating will wear over time under normal use, and this warranty does not cover normal wear and tear of the product (which varies per color of finish) or any damage, alteration, or abuse to the finish from neglect or accident. Exterior installation, exposure to UV light or salt spray will affect ceramic coating as part of normal wear and tear. INOX CeraMax ceramic coating is not UV rated. No representative or employee of INOX/Unison Hardware, Inc. is authorized to make any modification or addition to this warranty.

UNISON HARDWARE, INC. MAKES NO OTHER WARRANTY, AND ALL IMPLIED WARRANTIES INCLUDING ANY WARRANTY OF MERCHANTABILITY OR FITNESS FOR A PARTICULAR PURPOSE ARE LIMITED TO THE DURATION OF THE EXPRESSED WARRANTY PERIOD AS SET FORTH ABOVE. THE COMPANY'S MAXIMUM LIABILITY HEREUNDER IS LIMITED TO THE PURCHASE PRICE OF THE PRODUCT. IN NO EVENT SHALL THE COMPANY BE LIABLE FOR ANY CONSEQUENTIAL, INDIRECT, INCIDENTAL OR SPECIAL DAMAGES OF ANY NATURE ARISING FROM THE SALE OR USE OF THIS PRODUCT, WHETHER IN CONTRACT, TORT, STRICT LIABILITY OR OTHERWISE. THIS LIMITED WARRANTY IS IN LIEU OF ALL OTHER WARRANTIES, EXPRESSED OR IMPLIED, INCLUDING THE IMPLIED WARRANTIES OF FITNESS AND MERCHANTABILITY. THERE ARE NO WARRANTIES WHICH EXTEND BEYOND THE DESCRIPTION ON THE FACE HEREOF.

Care & Maintenance

Lever and Knob Handles

When installed correctly in accordance with the instructions, levers will not require initial adjustment. All fixings should be checked **from time to time based on conditions of use to adjust or tighten if needed**. Badly fitted hardware can cause interference with the operation of the lock and damage the surface or finish.

INOX® snap-on rose covers should only be removed using proper tools. **Be extremely careful to avoid marring the door and hardware finish if removing a snap-on rose cover. Contact INOX for more information.**

Care of Finishes

Today's environment exerts an immense toll on product material; hardware must be able to stand up to such atmospheric conditions as pollution, salt spray, and high humidity. Additionally, products must be protected against cleaning agents/solutions, and ideally the product should offer hypo-allergenic properties. Here are some tips **for** taking care of INOX finishes.

Stainless Steel is renowned for superior resistance to corrosion and for high performance with low maintenance. Stainless steel corrosion resistance is due to the presence of a thin, durable film of passive but stable chromium oxide. This film is inert, invisible, extremely adherent, and self-repairing, so it provides an unrivaled protection for steel; should the film be damaged or removed it will regenerate independently, provided oxygen is present to allow the reaction to occur with the chromium content of the steel. Therefore, you should ensure regular cleaning and maintenance of the hardware to restore the original surface appearance, prevent corrosion, and maintain hygienic conditions.

Cleaning

- Initially, wash down the surface using **a special polishing agent for stainless steel, such as Flitz, or soapy water or a very mild detergent**.
- Always thoroughly rinse the cleaning agent away with clean, warm water.
- Dry and polish the item with a soft, dry cloth. With aggressive conditions such as offshore, marine, and swimming pool environments, it is especially important to ensure that cleaning maintenance occurs regularly. Discoloration - If spots appear on the surface it is **not a property of** the stainless steel, but impurities in the water, the air or to cleaning agents that have not been thoroughly removed from the surface.
- Spots can be avoided by careful cleaning.
- If discoloration or spots occur, remove by using special polishing agents for stainless steel or a light scouring cream.
- Finally, rinse thoroughly with clean water and polish with a soft, dry cloth.

What to Avoid!

- Scouring powders **and pads**
- Steel wool
- Strong abrasive materials

Care of CeraMax™ Finishes

- CeraMax ceramic coating finishes can be easily cleaned by wiping with acetone or Windex® and a microfiber cloth. Never use abrasives **to clean ceramic coating**.

For further information on stainless steel **or CeraMax**, please contact your local INOX® sales representative.

INOX

6 Wayne Court, Sacramento, CA 95829, USA
 Tel: +1.916.388.1888 Fax: +1.916.388.8322
 Email: info@unisonhardware.com Web: www.inoxproducts.com

Terms and Conditions

PRICING

- List prices are effective on the date appearing on the cover and are subject to change without notice. List Prices are subject to discounts in effect at the time orders are acknowledged in writing.
- If, under any law now or hereafter passed, the seller is required to pay a tax on sales or an excise tax, the amount of these taxes will be added to the invoice value.
- Errors or omissions are subject to correction.
- All quoted jobs must clearly reference the quote number on the purchase order to receive special quoted prices.
- Delivery – Unison Hardware, Inc. (“INOX”) will not be responsible for any loss or damage resulting from delay in filling orders caused by fire, flood, strikes, differences with workers, government regulations, accidents, transportation delays, shortages of materials, or other causes beyond our control.
- Materials – Should raw material prices rise substantially it may become necessary to add a surcharge by material type at the time of shipment. Orders are processed in order of receipt but lead times will vary in relation to production specifications. Errors or omissions in published prices are subject to correction.

PAYMENT

- Unison Hardware, Inc. (“INOX”) will provide an invoice by email to customer once products have been shipped. Printed copies are only available upon request.
- Customer shall make payment in US Dollars to INOX according to the invoice amount without any other deduction, credit or set off within 30 (Thirty) Days of the date of invoice; or otherwise in accordance with such credit terms as may have been agreed in writing between INOX and the Customer.
- If a payment by check incurs a NSF (non-sufficient funds) bank charge a \$50.00 fee will be added to the account.
- INOX is not obliged to accept orders from any Customer who has not supplied INOX with references satisfactory to INOX. If at any time INOX is not satisfied as to the creditworthiness of the Customer, it may give notice in writing or electronically to the Customer that no further credit will be allowed to the Customer, in which event no further goods or services will be delivered or provided to the Customer other than against advance cash payment; and all amounts owing by the Customer to INOX shall be immediately payable.
- Customer accounts unpaid at the expiration of 90-days from the date of invoice will be subject to a late payment charge of 2% per month of the total balance or the highest rate permissible by law if less. Also, accounts unpaid after 90-days will be subject to C.O.D. shipments. Accounts unpaid after 90-days will be placed for collection. All collection charges, attorney fees, and court costs will be added to the amount due.
- Discount level, credit limit and payment terms will be re-evaluated for accounts unpaid 3 times at expiration of 90-days from the date of invoice.
- Prepayment Terms:
 - * Payment must be received in full before shipments are released.
 - * All Customer accounts are on prepayment term until credit application is submitted and approved. A credit application form must be filled out and is subject to approval before any credit payment terms are extended to Customers.
 - * For special order items, a deposit may be required before production starts.
 - * For orders over Customer’s credit limit, prepayment of the difference must be collected before order is accepted.

MINIMUM ORDER CHARGES

- Orders with a net value of less than \$50.00 are subject to a \$5.00 handling fee added to the invoice.

MINIMUM ANNUAL PURCHASE REQUIREMENTS FOR ACTIVE ACCOUNT

- A minimum annual purchase amount of \$7500.00 is required to maintain an open account with INOX.

PRODUCT CHANGES

- INOX reserves the right to make changes or improvements in design, material, parts, or specifications, as well as to discontinue products at any time.

Terms and Conditions

SHIPPING AND FREIGHT CHARGES

- All shipments are F.O.B. Sacramento CA. Shipping is prepaid to the contiguous U.S. on orders having a value of \$1,000.00 net with standard discount. Freight prepaid on orders of \$2,500 net or more to Alaska, Hawaii and Canada. Shipping and Freight prepaid on shipments of \$2,500 net or more for projects with deeper than standard discounts. Any other international destination shipping and/or freight to be quoted. Any request for shipments not falling under these guidelines may be subject to a handling charge.
- INOX will not provide consignee or third-party freight billing.
- Requests for shipping methods other than Ground, e.g., Next Day, 2 Day, 3 Day, etc., must be made in writing.

ORDER CANCELLATIONS

- Any orders for made-to-order and/or non-stock goods accepted by INOX are non-cancellable except with prior written consent, and if consent is granted will be subject to a service charge based on the manufacturing expenses incurred. Under no circumstances will non-stock, made-to-order or discontinued product be accepted for return unless due to INOX error.

RETURN GOODS AUTHORIZATION POLICY

- INOX accepts returns of resalable items with original packaging within 90 days of invoice date, subject to a 30% restocking fee and customer-paid return shipping. Returns require a Return Goods Authorization (RGA) and minimum value of \$25. Custom hardware, specialty finishes (CeraMax ceramic coating, laser art), and OEM products are non-returnable. For warranty claims on defective items, INOX conducts inspection upon receipt. Approved warranty claims receive reimbursement or replacement of the item, including shipping charges. Customers have 5 business days to provide disposal instructions for rejected returns, after which items will be recycled. Visit <https://www.inoxproducts.com/faqs> for complete details and return initiation.

WARRANTY RETURNS

- A credit in the amount of the original purchase order will be issued after the returned product is inspected and the defect is found to be valid.

DELIVERY AND INSPECTION

- Customer will inspect all product deliveries immediately upon receipt. INOX will assume acceptance of delivered product if not notified within 5-days of receipt of product.

CLAIMS

- All claims should be submitted to INOX as follows:
- All claims for pricing adjustments must be submitted within 30-days of invoice date.
- All claims for order quantity discrepancies must be submitted within 5-days of receipt of product.
- All claims for damaged material prior to acceptance by customer must be submitted within 5-days of receipt of product.

LIMITED WARRANTY

- Subject to the limitations of liability set forth below, Unison Hardware, Inc. ("INOX") warrants to first purchaser that the products which INOX sells under the "Unison" and/or "INOX" trademark/s and/or trade names are free from defects in workmanship and materials under normal use and regular service and maintenance from date of delivery.
- This is the sole and exclusive warranty given by INOX with respect to the products and is in lieu of any and all other warranties, express or implied, arising by operation of law or otherwise. All implied warranties, including but not limited to the warranties of merchantability, non-infringement and fitness for a particular purpose, are hereby excluded.
- This warranty does not cover defects or damage arising from improper installation, incorrect application, lack of or improper maintenance, improper storage, shipping and handling, excessive wear and tear, misuse, abuse, accident, unauthorized service, or use with unauthorized products or parts. INOX warrants its products from the date of delivery for a period as follows:

Terms and Conditions

	Residential		Commercial		
	Interior	Exterior*	Interior	Exterior*	
Mechanical	10-Year	3-Year	3-Year	1-Year	
Electronic	2-Year	1-Year**	1-Year	1-Year**	
Finish	Stainless Steel	10-Year	3-Year	1-Year	
	PVD	10-Year	3-Year	1-Year	
	CeraMax	10-Year	3-Year	1-Year	
	Powder Coating	10-Year	3-Year	1-Year	
	ElectroPlated	2-Year	1-Year	1-Year	
	Living Finish	N/A	N/A	N/A	N/A
	Unlacquered	N/A	N/A	N/A	N/A

*Exterior means doors facing outside of the property but with overhang.

Completely exposed under the weather is not included in this warranty unless it has an IP65 Outdoor Rating.

** Only when products with IP65 outdoor rating.

The sole and exclusive liability of INOX under this warranty or otherwise, shall be limited to the repair or replacement of any product or component part which shall prove defective to the original purchaser from INOX. INOX will not pay for the costs or repair performed other than in accordance with this warranty. INOX shall not be liable for damages caused by delay in performance and in no event, regardless of the form of the claim or cause of action (whether based on contract, infringement, negligence, strict liability, other tort or otherwise) shall INOX's liability to purchaser and/or its customers exceed the price paid by purchaser for the specific products giving rise to the claim or cause of action. Purchaser agrees that in no event shall INOX's liability to purchaser and/or its customers extend to include incidental, consequential or punitive damages resulting from use of these products or arising out of any breach of this warranty. The term "consequential damages" shall include, but is not limited to, loss of anticipated profits, business interruption, loss of use or revenue, cost of capital or loss or damage to property or equipment. The foregoing limitations and exclusions are intended to be effective to the maximum extent permitted by law. This warranty is governed by the law of the State of California without regard to its conflicts of law principles. INOX and purchaser agree that the United Nations Convention on Contracts for the International Sale of Goods and the United Nations Convention on the Limitation Period in the International Sale of Goods shall not apply to sales of the products covered by this warranty.

Written notice of a product believed to be defective as covered by this Warranty should be sent to Unison Hardware, Inc. (INOX), 6 Wayne Court, Sacramento CA 95829 within 30-days from the discovery of the alleged defects, and should include the purchaser's name and address, identification of the product, and brief description of the defect. Upon receipt of such notice, INOX will inform the purchaser where to ship such product, shipping charges prepaid, for examination. In the event such examination reveals a defect covered by this warranty, INOX will, at its own option, repair or replace the product, and return it or the replacement to the purchaser, with charge only for transportation.

The completion, signing and submission of this Agreement by Customer to INOX for consideration of a credit account constitute understanding and acceptance of this Agreement's terms and conditions.

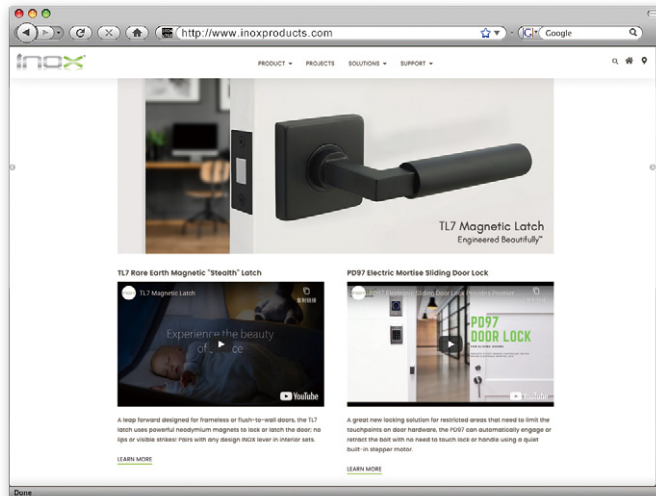

Please visit our website
www.inoxproducts.com
for more technical and new product information.

INOX™

6 Wayne Court, Sacramento, CA 95829, USA

Tel: +1.916.388.1888

Email: info@unisonhardware.com

Web: www.inoxproducts.com

DEPARTMENT EMAIL

Purchase Orders: orders@unisonhardware.com

Account Management: sales@unisonhardware.com

Return Requests: returns@unisonhardware.com

Marketing: marketing@unisonhardware.com

Support: support@unisonhardware.com

Sales: sales@unisonhardware.com